



ZIMAIZ
INTERNATIONAL



Plastic Surgery Instruments

SURGICAL
INSTRUMENTS
CATALOGUE





CONTENTS

• Areola Markers	2
• Auricular Plastic Instruments	3
• Breast Dissectors and Elevator	4-7
• Breast Retractors	8-19
• Cartilage And Bone Instruments	20-22
• Chisels and Gouges	23-26
• Dermatomes	27
• Dissectors and Elevators	28-35
• Lip and Cheek Retractors	36
• Lip and Cleff Palate Instruments	37-38
• Mallets	39
• Marking And Measuring Instruments	40-43
• Maxilla Mobilizer	43
• Mouth Gags	44
• Mucosa Knife And Raspatories	45
• Rhinoplasty Instruments	46-68
• Septum Straightening Forceps	69-70
• Osteotomes and Raspatories	71-85
• Suction Raspatories	86
• Wires And Wire Instruments	87
• Suggested Instruments	88
• Delicate Dressing & Tissue Forceps	89-92
• Hemostatic Forceps	93-96
• Micro Forceps	97-99
• Tissue Grasping Forceps	100-101
• Needle Holders	102-109
• Micro Needle Holders	110-111
• Retractors	112-123
• Delicate Retractors	124-131
• Self Retaining Retractors	132-134
• Scalpel Handles	135-136
• Delicate Scissors	137-139
• Delicate Dissecting Scissors	140-146
• Dissecting Scissors	147-158
• Gum Scissors	159
• Ligature and Stitch Scissors	160-161
• Micro Scissors	162-163
• Liposuction Cannulas	164-209
• Liposuction Cannulas Accessories	210-212
• Liposuction Cannulas Set	213-218



Areola Markers



Item Code	Description
01-ZA-02	GROSSMANN AREOLA MARKER, 40MM,44MM 48MM, 52MM



Item Code	Description
01-ZA-06	FREEMAN AREOLA MARKER, 2 SIZES, 34MM / 36MM
01-ZA-07	FREEMAN AREOLA MARKER, 2 SIZES, 38MM / 42MM
01-ZA-08	FREEMAN AREOLA MARKER, 2 SIZES, 42MM / 45MM
01-ZA-09	FREEMAN AREOLA MARKER, 2 SIZES, 45MM / 50MM



Item Code	Description
01-ZA-22	FREEMAN AREOLA MARKER, 34MM
01-ZA-23	FREEMAN AREOLA MARKER, 36MM
01-ZA-24	FREEMAN AREOLA MARKER, 38MM
01-ZA-25	FREEMAN AREOLA MARKER, 42MM
01-ZA-26	FREEMAN AREOLA MARKER, 45MM
01-ZA-27	FREEMAN AREOLA MARKER, 50MM



Item Code	Description
01-ZA-31	FREEMAN AREOLA MARKER, 38 MM
01-ZA-32	FREEMAN AREOLA MARKER, 42 MM
01-ZA-33	FREEMAN AREOLA MARKER, 50 MM
01-ZA-34	FREEMAN AREOLA MARKER, 45 MM
01-ZA-35	FREEMAN AREOLA MARKER, 34 MM
01-ZA-36	FREEMAN AREOLA MARKER, 36 MM

STAINLESS STEEL



Item Code	Description
01-ZA-41	SOLZ AREOLA MARKER, BLUNT, 36MM DIAMETER
01-ZA-42	SOLZ AREOLA MARKER, BLUNT, 40MM DIAMETER
01-ZA-43	SOLZ AREOLA MARKER, BLUNT, 42MM DIAMETER
01-ZA-44	SOLZ AREOLA MARKER, BLUNT, 45MM DIAMETER



Auricular Plastic Instruments



Item Code	Description
02-API-01	UNIVERSAL T. C. WIRE CUTTING SCISSORS, 12CM



Item Code	Description
02-API-02	NIROY T.C. WIRE TWISTING FORCEPS, 15CM



Item Code	Description
02-API-03	NAGATA AURICULAR SEPTUM ELEVATOR, 16CM, BLUNT
02-API-04	NAGATA AURICULAR SEPTUM ELEVATOR, 17CM, BLUNT



Item Code	Description
02-API-05	DOYEN RIB RASPATORY, 17CM, RIGHT
02-API-06	DOYEN RIB RASPATORY, 17CM, LEFT

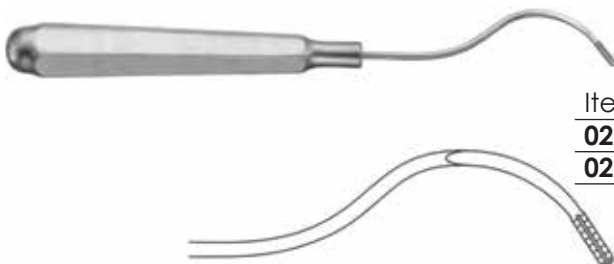

Item Code	Description
02-API-07	KISTLER ANHELIX CARTILAGE RASP, RIGHT
02-API-08	KISTLER ANHELIX CARTILAGE FILE, LEFT



Breast Dissectors and Elevator



Item Code	Description
03-BD-01	SOLZ ATRAUMATIC BREAST DISSECTOR, 34CM
03-BD-02	SOLZ ATRAUMATIC BREAST DISSECTOR, 37CM



Item Code	Description
03-BD-03	SOLZ BREAST HOOK DISSECTOR, 36CM



Item Code	Description
03-BD-04	AGRIS DINGMAN BREAST DISSECTOR, SET OF 2, LEFT AND RIGHT, 36CM



Item Code	Description
03-BD-07	MACCOLLUM DINGMAN SUBMAMMARY DISSECTOR, 30 CM

Breast Dissectors and Elevator



Item Code	Description
03-BD-08	MACCOLLUM DINGMAN BREAST DISSECTOR, 31.5 CM
03-BD-09	MACCOLLUM DINGMAN BREAST DISSECTOR, 41 CM



Item Code	Description
03-BD-10	REYNOLDS TRANSAUXILLARY BREAST DISSECTOR, FENESTRATED, 33CM
03-BD-11	REYNOLDS TRANSAUXILLARY BREAST DISSECTOR, FENESTRATED, 40CM



ZIMAIZ
INTERNATIONAL

Item Code	Description
03-BD-12	BREAST DISSECTOR, ANGULATED BLADE, 33CM
03-BD-13	BREAST DISSECTOR, ANGULATED BLADE, 42CM



Item Code	Description
03-BD-14	BREAST DISSECTOR, SPATULATED BLADE, 33CM
03-BD-15	BREAST DISSECTOR, SPATULATED BLADE, 42CM



Item Code	Description
03-BD-16	BREAST DISSECTOR, OVAL SPATULATED BLADE, 33CM
03-BD-17	BREAST DISSECTOR, OVAL SPATULATED BLADE, 42CM



Breast Dissectors and Elevator



Item Code	Description
03-BD-20	TROCAR BREAST TUBE, 14" (356 MM) TOTAL LENGTH, LARGE, 17.3 MM ID, 19.0 MM OD
03-BD-21	TROCAR BREAST TUBE, 13 1/2" (343), SMALL, 14 MM ID, 16 MM OD



Item Code	Description
03-BD-29	PENN BREAST DISSECTOR, STRAIGHT, 1" (25 MM) WIDTH, 12 3/4" (324 MM) LENGTH



03-BD-30	MACCOLLUM DINGMAN BREAST DISSECTOR, 1 1/2" (38 MM) WIDTH, 17 1/2" (432 MM) LENGTH
-----------------	---



Item Code	Description
03-BD-32	MCINNIS POLYCURETTE BREAST INSTRUMENT, 1 11/64" (30 MM) WIDTH, 12 1/2" (318 MM) LENGTH



Item Code	Description
03-BD-33	ICONOCLAST, LARGE, 11 1/2" (292 MM) LENGTH, 5 3/4" (146 MM) BLADE
03-BD-34	ICONOCLAST, SMALL, 8 3/4" (222 MM) LENGTH, 3 1/4" (83 MM) BLADE

Breast Dissectors and Elevator



Item Code	Description
03-BD-35	SILVERSTEIN BREAST DISSECTOR, 14" (356 MM) LENGTH



Item Code	Description
03-BD-36	SPATULA BREAST RETRACTOR / DISSECTOR, SERRATED, 12 1/2", SEMI MALLEABLE



Item Code	Description
04-BE-01	BREAST ELEVATOR FOR MAMMARY PLASTY



Breast Retractors

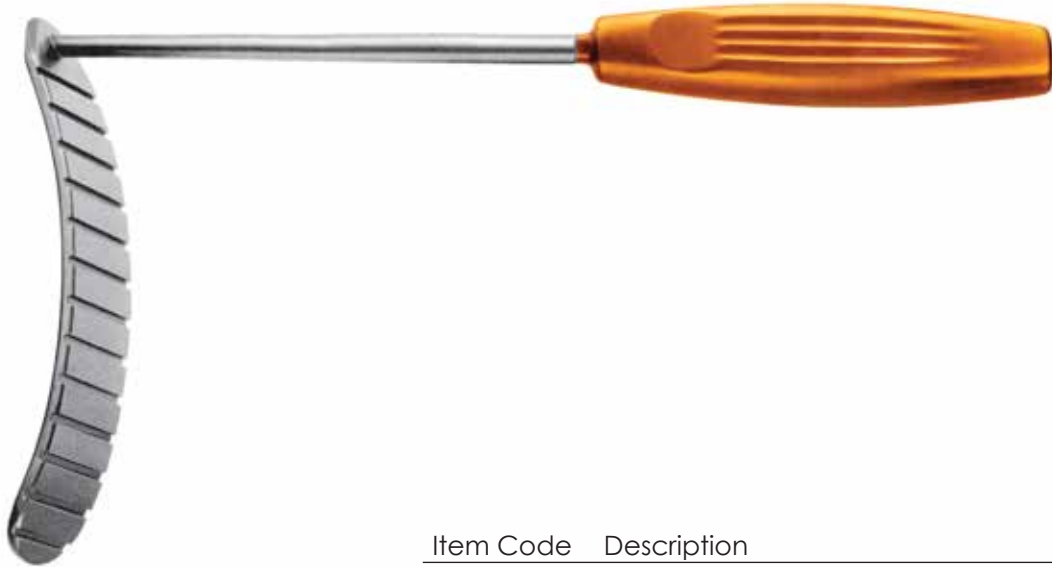

Item Code	Description
05-BR-01	MARX BREAST RETRACTOR, 27CM, 125 X 30MM
05-BR-02	MARX BREAST RETRACTOR, 27CM, 140 X 30MM



FERRIERA STYLE RETRACTOR, WITH FIBER OPTIC LIGHT GUIDE

With Smoke Tube		Without Smoke Tube	
Item Code	Description	Item Code	Description
05-BR-03-01	70 X 16 mm	05-BR-03-16	70 X 16 mm
05-BR-03-02	80 X 16 mm	05-BR-03-17	80 X 16 mm
05-BR-03-03	90 X 27 mm	05-BR-03-18	90 X 27 mm
05-BR-03-04	110 X 25 mm	05-BR-03-19	110 X 25 mm
05-BR-03-05	120 X 25 mm	05-BR-03-20	120 X 25 mm
05-BR-03-06	130 X 16 mm	05-BR-03-21	130 X 16 mm
05-BR-03-07	130 X 25 mm	05-BR-03-22	130 X 25 mm
05-BR-03-08	150 X 25 mm	05-BR-03-23	150 X 25 mm
05-BR-03-09	150 X 30 mm	05-BR-03-24	150 X 30 mm
05-BR-03-10	150 X 36 mm	05-BR-03-25	150 X 36 mm
05-BR-03-11	180 X 16 mm	05-BR-03-26	180 X 16 mm
05-BR-03-12	180 X 25 mm	05-BR-03-27	180 X 25 mm
05-BR-03-13	190 X 25 mm	05-BR-03-28	190 X 25 mm
05-BR-03-14	190 X 36 mm	05-BR-03-29	190 X 36 mm
05-BR-03-15	220 X 27 mm	05-BR-03-30	220 X 27 mm



Item Code	Description
05-BR-19	BIGGS MAMMAPLASTY RETRACTORS, 30MM, WITH FIBER OPTIC LIGHT GUIDE
05-BR-20	BIGGS MAMMAPLASTY RETRACTORS, 50MM, WITH FIBER OPTIC LIGHT GUIDE
05-BR-21	BIGGS MAMMAPLASTY RETRACTORS, 30MM, WITH FIBER OPTIC LIGHT GUIDE AND SUCTION
05-BR-22	BIGGS MAMMAPLASTY RETRACTORS, 50MM, WITH FIBER OPTIC LIGHT GUIDE AND SUCTION



Breast Retractors



Item Code	Description
05-BR-25	WIEDER BREAST AND FACIAL RETRACTOR / TONGUE DEPRESSOR, SERRATED, (14 CM), 28MM, WITH FIBER OPTIC LIGHT GUIDE
05-BR-26	WIEDER BREAST AND FACIAL RETRACTOR / TONGUE DEPRESSOR, SERRATED, (14 CM), 38MM, WITH FIBER OPTIC LIGHT GUIDE
05-BR-27	WIEDER BREAST AND FACIAL RETRACTOR / TONGUE DEPRESSOR, SERRATED, (15 CM), 45MM, WITH FIBER OPTIC LIGHT GUIDE



Item Code	Description
05-BR-28	BREAST SPATULA WITH HANDLE 31.5 CM, 25MM X 18 CM BLADE, SERRATED TIP, SEMI MALLABLE



Item Code	Description
05-BR-29	BREAST RETRACTOR, DOUBLE ENDED, (31 CM), BLADES 22MM X 55MM AND 38MM X 70MM
05-BR-31	BREAST RETRACTOR, DOUBLE ENDED, (24 CM), BLADES 22MM X 55MM AND 38MM X 70MM

Breast Retractors



Item Code	Description
05-BR-32	WIEDER BREAST AND FACIAL RETRACTOR / TONGUE DEPRESSOR, SERRATED, (14 CM), 28MM
05-BR-33	WIEDER BREAST AND FACIAL RETRACTOR / TONGUE DEPRESSOR, SERRATED, (14 CM), 38MM
05-BR-34	WIEDER BREAST AND FACIAL RETRACTOR / TONGUE DEPRESSOR, SERRATED, (15 CM), 45MM



Item Code	Description
05-BR-35	BIGGS MAMMAPLASTY RETRACTOR, 50 MM WIDTH, STANDARD, 20 CM LENGTH



Breast Retractors



Item Code	Description
05-BR-36	BIGGS MAMMAPLASTY RETRACTOR, WITH FIBER OPTIC LIGHT GUIDE 5.0 CM BLADE WIDTH, 20 CM LENGTH



Item Code	Description
05-BR-37	BIGGS MAMMAPLASTY RETRACTOR, 3 CM BLADE WIDTH, NARROW, (171 MM) LENGTH

Breast Retractors



Item Code	Description
05-BR-38	BIGGS MAMMAPLASTY RETRACTOR, WITH FIBER OPTIC LIGHT GUIDE, NARROW, 3.0 CM BLADE WIDTH, 15 CM LENGTH

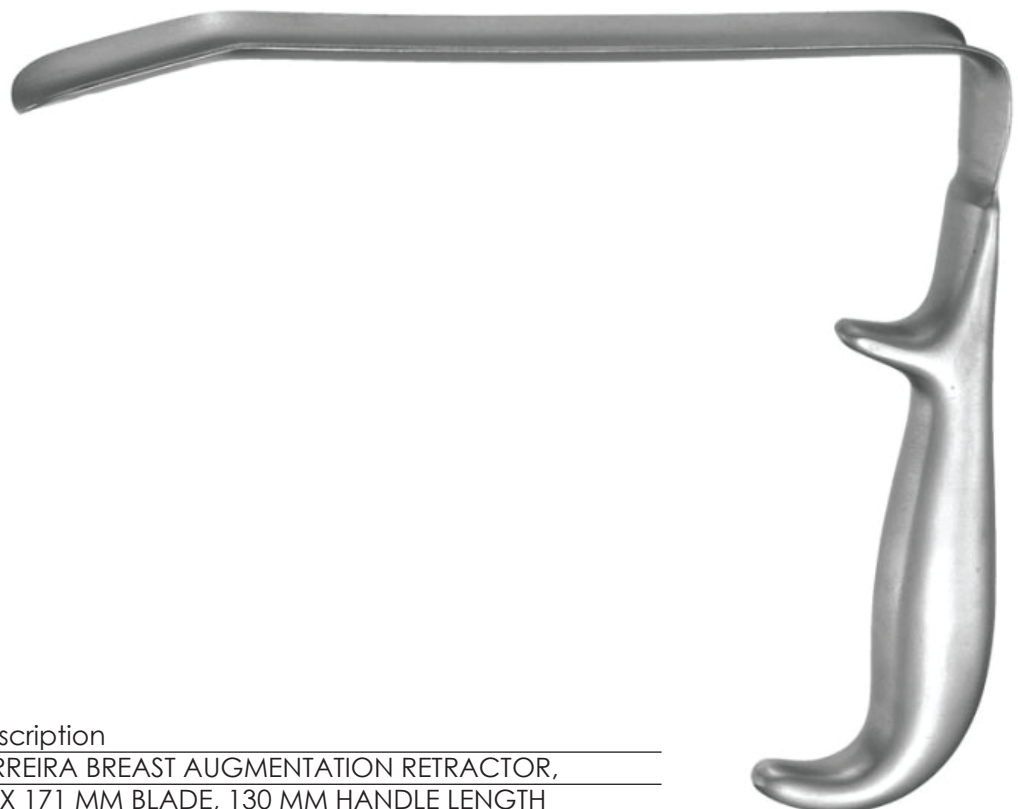

Item Code	Description
05-BR-39	FERREIRA BREAST AUGMENTATION RETRACTOR, 25 X 171 MM BLADE, 130 MM HANDLE LENGTH



Breast Retractors



Item Code	Description
05-BR-40	FERREIRA BREAST AUGMENTATION RETRACTOR, WITH FIBER OPTIC LIGHT GUIDE, 25 X 171 MM BLADE WIDTH, 130 MM HANDLE LENGTH WIDTH



TEBBETTS RETRACTOR WITH FIBER OPTIC LIGHT GUIDE, 18.5CM

With IRRIGATION TUBE

Item Code	Description
05-BR-41-01	70 X 16 mm
05-BR-41-02	80 X 16 mm
05-BR-41-03	90 X 27 mm
05-BR-41-04	110 X 25 mm
05-BR-41-05	120 X 25 mm
05-BR-41-06	130 X 16 mm
05-BR-41-07	130 X 25 mm
05-BR-41-08	150 X 25 mm
05-BR-41-09	150 X 30 mm
05-BR-41-10	150 X 36 mm
05-BR-41-11	180 X 16 mm
05-BR-41-12	180 X 25 mm
05-BR-41-13	190 X 25 mm
05-BR-41-14	190 X 36 mm
05-BR-41-15	220 X 27 mm

Without IRRIGATION TUBE

Item Code	Description
05-BR-41-16	70 X 16 mm
05-BR-41-17	80 X 16 mm
05-BR-41-18	90 X 27 mm
05-BR-41-19	110 X 25 mm
05-BR-41-20	120 X 25 mm
05-BR-41-21	130 X 16 mm
05-BR-41-22	130 X 25 mm
05-BR-41-23	150 X 25 mm
05-BR-41-24	150 X 30 mm
05-BR-41-25	150 X 36 mm
05-BR-41-26	180 X 16 mm
05-BR-41-27	180 X 25 mm
05-BR-41-28	190 X 25 mm
05-BR-41-29	190 X 36 mm
05-BR-41-30	220 X 27 mm





Breast Retractors

Tebbetts Fiber Optic retractor,
With Double Handle and Teeth at Tip

With Smoke Tube	
Item Code	Description
R-09-53-01	70 X 16 mm
R-09-53-02	80 X 16 mm
R-09-53-03	90 X 27 mm
R-09-53-04	110 X 25 mm
R-09-53-05	120 X 25 mm
R-09-53-06	130 X 16 mm
R-09-53-07	130 X 25 mm
R-09-53-08	150 X 25 mm
R-09-53-09	150 X 30 mm
R-09-53-10	150 X 36 mm
R-09-53-11	180 X 16 mm
R-09-53-12	180 X 25 mm
R-09-53-13	190 X 25 mm
R-09-53-14	190 X 36 mm
R-09-53-15	220 X 27 mm

Without Smoke Tube	
Item Code	Description
R-09-53-16	70 X 16 mm
R-09-53-17	80 X 16 mm
R-09-53-18	90 X 27 mm
R-09-53-19	110 X 25 mm
R-09-53-20	120 X 25 mm
R-09-53-21	130 X 16 mm
R-09-53-22	130 X 25 mm
R-09-53-23	150 X 25 mm
R-09-53-24	150 X 30 mm
R-09-53-25	150 X 36 mm
R-09-53-26	180 X 16 mm
R-09-53-27	180 X 25 mm
R-09-53-28	190 X 25 mm
R-09-53-29	190 X 36 mm
R-09-53-30	220 X 27 mm

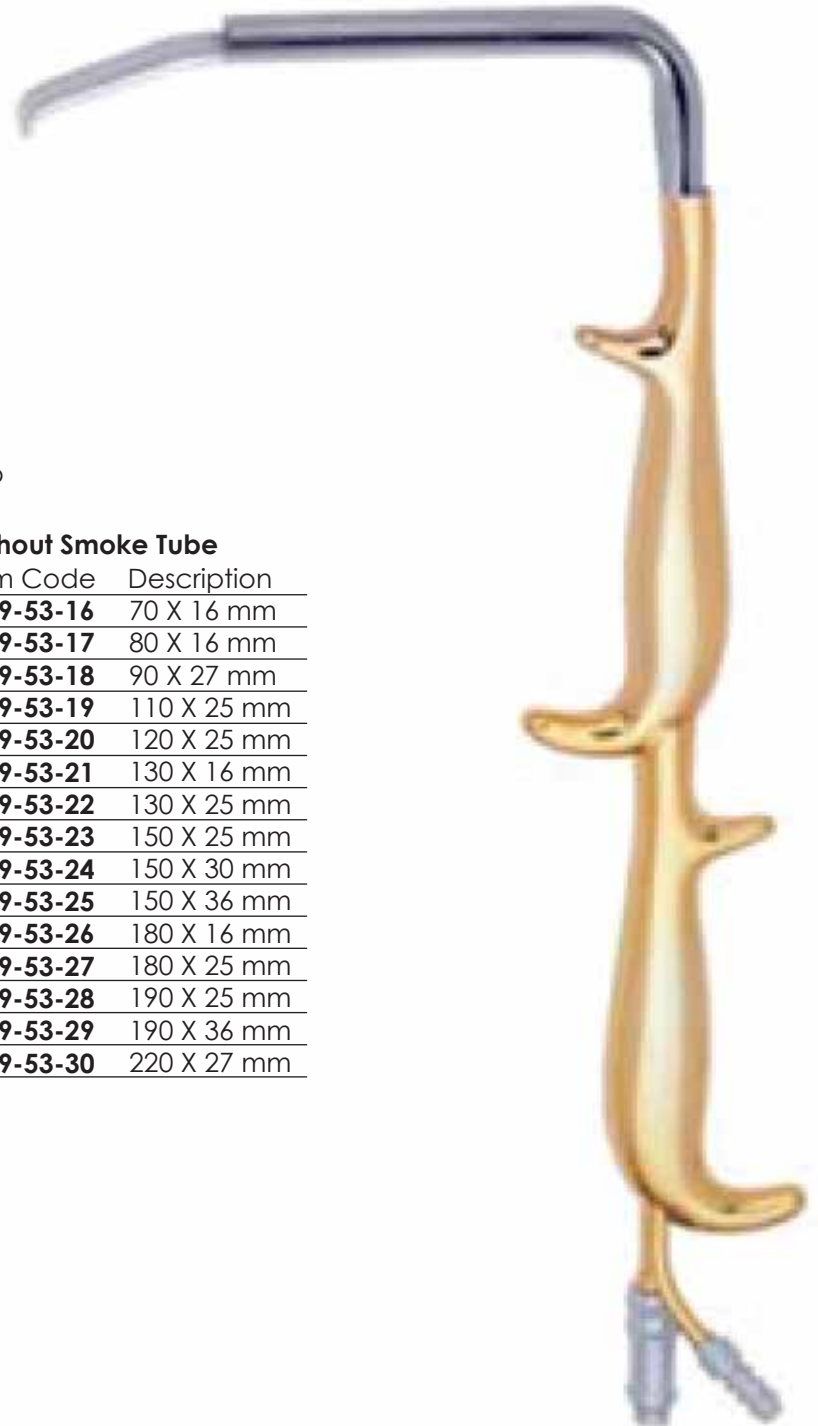

Breast Retractors

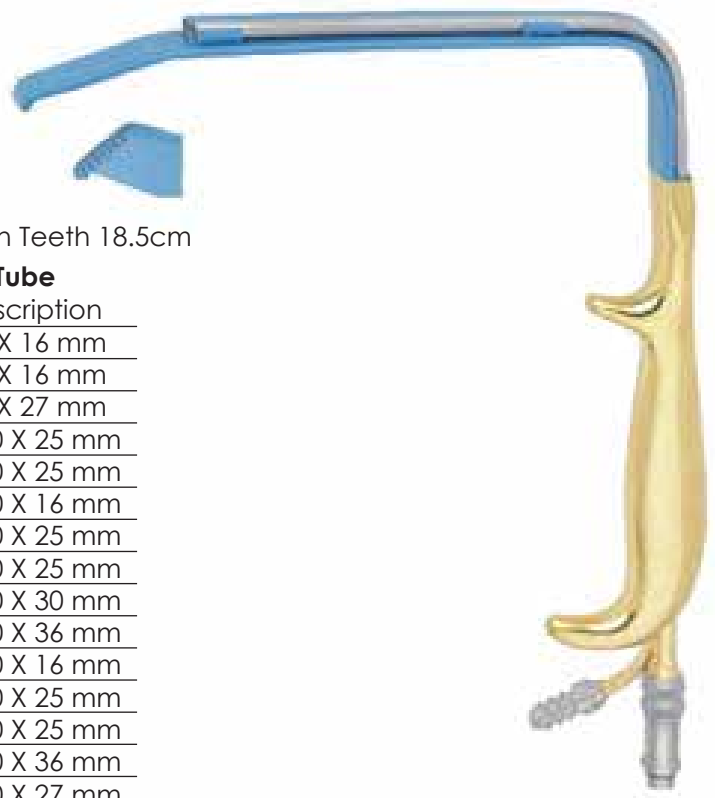

Tebbetts Fiber Optic retractor, Insulated Blade With Teeth 18.5cm

With Smoke Tube		Without Smoke Tube	
Item Code	Description	Item Code	Description
R-09-54-01	70 X 16 mm	R-09-54-16	70 X 16 mm
R-09-54-02	80 X 16 mm	R-09-54-17	80 X 16 mm
R-09-54-03	90 X 27 mm	R-09-54-18	90 X 27 mm
R-09-54-04	110 X 25 mm	R-09-54-19	110 X 25 mm
R-09-54-05	120 X 25 mm	R-09-54-20	120 X 25 mm
R-09-54-06	130 X 16 mm	R-09-54-21	130 X 16 mm
R-09-54-07	130 X 25 mm	R-09-54-22	130 X 25 mm
R-09-54-08	150 X 25 mm	R-09-54-23	150 X 25 mm
R-09-54-09	150 X 30 mm	R-09-54-24	150 X 30 mm
R-09-54-10	150 X 36 mm	R-09-54-25	150 X 36 mm
R-09-54-11	180 X 16 mm	R-09-54-26	180 X 16 mm
R-09-54-12	180 X 25 mm	R-09-54-27	180 X 25 mm
R-09-54-13	190 X 25 mm	R-09-54-28	190 X 25 mm
R-09-54-14	190 X 36 mm	R-09-54-29	190 X 36 mm
R-09-54-15	220 X 27 mm	R-09-54-30	220 X 27 mm

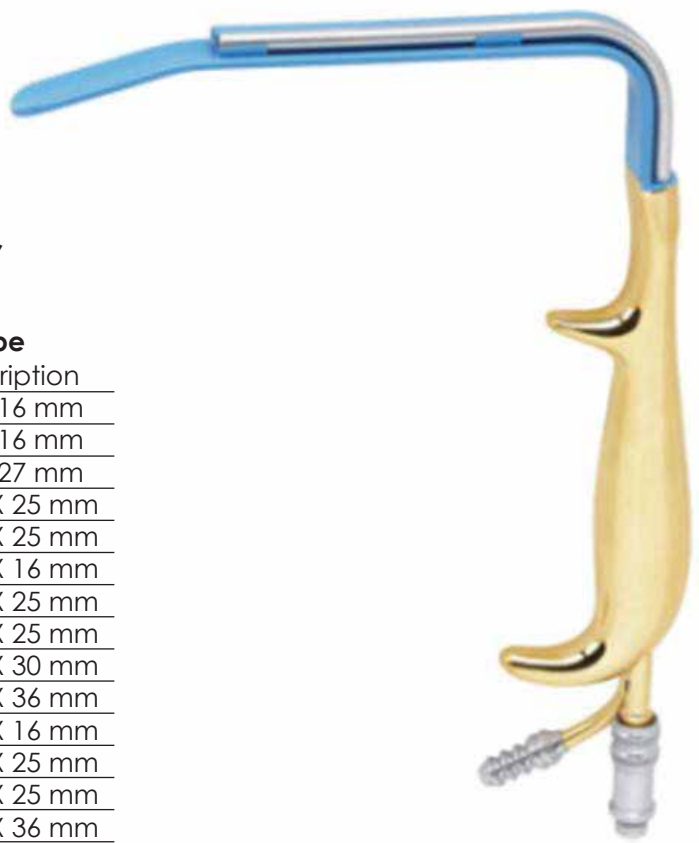

Tebbetts Breast Augmentation Fiber Optic Retractor, Insulated Blade With Smooth End, 18.5 cm

With Smoke Tube		Without Smoke Tube	
Item Code	Description	Item Code	Description
R-09-56-01	70 X 16 mm	R-09-56-16	70 X 16 mm
R-09-56-02	80 X 16 mm	R-09-56-17	80 X 16 mm
R-09-56-03	90 X 27 mm	R-09-56-18	90 X 27 mm
R-09-56-04	110 X 25 mm	R-09-56-19	110 X 25 mm
R-09-56-05	120 X 25 mm	R-09-56-20	120 X 25 mm
R-09-56-06	130 X 16 mm	R-09-56-21	130 X 16 mm
R-09-56-07	130 X 25 mm	R-09-56-22	130 X 25 mm
R-09-56-08	150 X 25 mm	R-09-56-23	150 X 25 mm
R-09-56-09	150 X 30 mm	R-09-56-24	150 X 30 mm
R-09-56-10	150 X 36 mm	R-09-56-25	150 X 36 mm
R-09-56-11	180 X 16 mm	R-09-56-26	180 X 16 mm
R-09-56-12	180 X 25 mm	R-09-56-27	180 X 25 mm
R-09-56-13	190 X 25 mm	R-09-56-28	190 X 25 mm
R-09-56-14	190 X 36 mm	R-09-56-29	190 X 36 mm
R-09-56-15	220 X 27 mm	R-09-56-30	220 X 27 mm



Breast Retractors

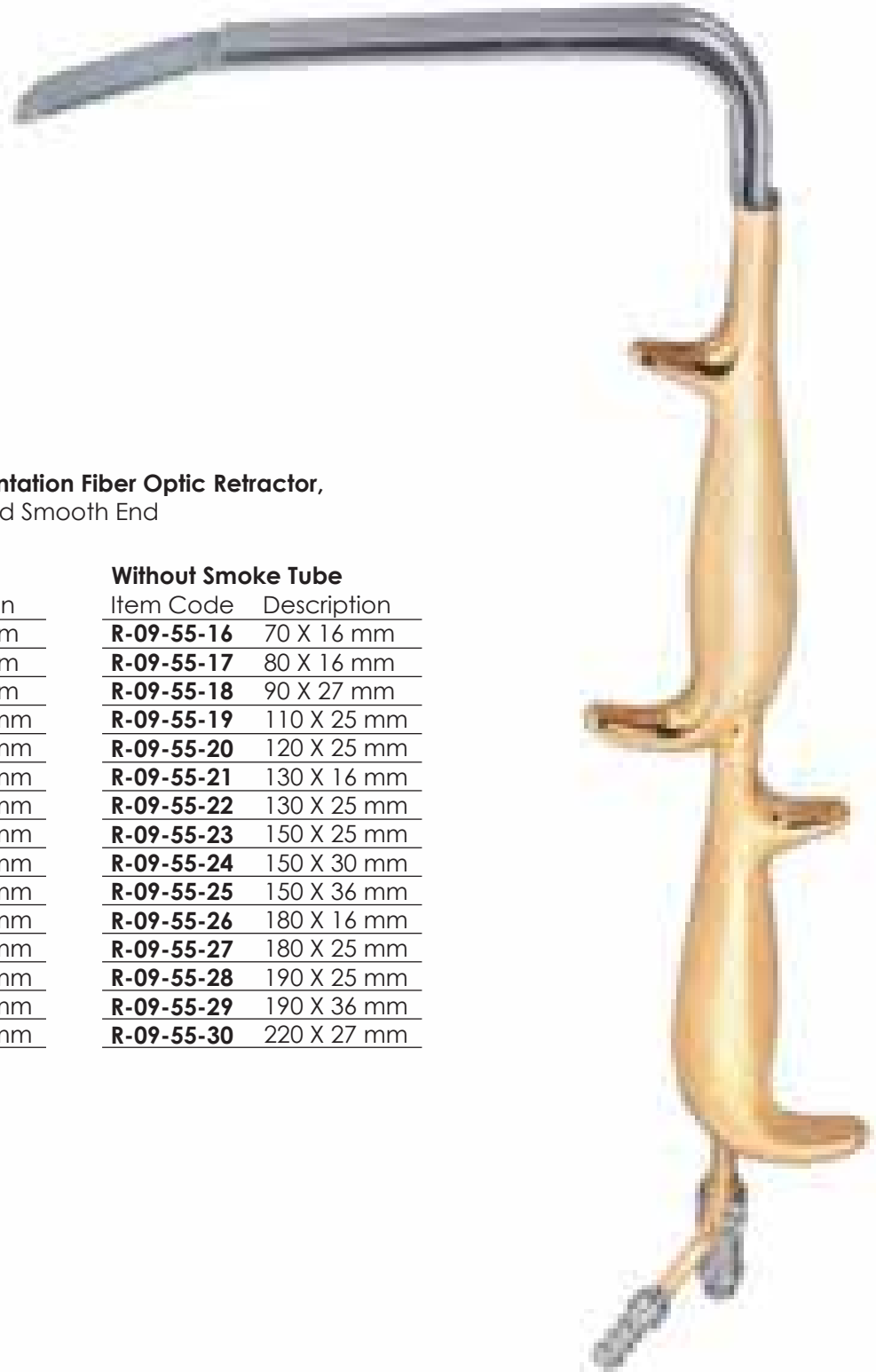

Tebbetts Breast Augmentation Fiber Optic Retractor, With Double Handle and Smooth End

With Smoke Tube

Item Code	Description
R-09-55-01	70 X 16 mm
R-09-55-02	80 X 16 mm
R-09-55-03	90 X 27 mm
R-09-55-04	110 X 25 mm
R-09-55-05	120 X 25 mm
R-09-55-06	130 X 16 mm
R-09-55-07	130 X 25 mm
R-09-55-08	150 X 25 mm
R-09-55-09	150 X 30 mm
R-09-55-10	150 X 36 mm
R-09-55-11	180 X 16 mm
R-09-55-12	180 X 25 mm
R-09-55-13	190 X 25 mm
R-09-55-14	190 X 36 mm
R-09-55-15	220 X 27 mm

Without Smoke Tube

Item Code	Description
R-09-55-16	70 X 16 mm
R-09-55-17	80 X 16 mm
R-09-55-18	90 X 27 mm
R-09-55-19	110 X 25 mm
R-09-55-20	120 X 25 mm
R-09-55-21	130 X 16 mm
R-09-55-22	130 X 25 mm
R-09-55-23	150 X 25 mm
R-09-55-24	150 X 30 mm
R-09-55-25	150 X 36 mm
R-09-55-26	180 X 16 mm
R-09-55-27	180 X 25 mm
R-09-55-28	190 X 25 mm
R-09-55-29	190 X 36 mm
R-09-55-30	220 X 27 mm

Breast Retractors



Item Code	Description
R-09-57-01	Sculpo Breast Retractors, 180 X 25mm Blade Size, With 5mm Endoscopic Scope Sheath
R-09-57-02	Sculpo Breast Retractors, 180 X 25mm Blade Size, With 10mm Endoscopic Scope Sheath



Item Code	Description
R-09-62	Ring breast retractor with fiber optic illumination and irrigation tube



CARTILAGE AND BONE INSTRUMENTS



Item Code	Description
06-CBI-01	MAYO SCISSORS, SUPERCUT PLUS T.C. (TUNGSTEN CARBIDE) 17CM, CURVED



Item Code	Description
06-CBI-03	COTTLE CARTILAGE CRUSHER, WITH CLAMP, FOR TAKING OUT THE PREPARED MATERIAL, 65X30X30MM



Item Code	Description
06-CBI-04	CARTILAGE CUTTING BLOCK, TEFLON, 85X55X10MM



Item Code	Description
06-CBI-05	GUBISCH CARTILAGE CRUSHER, 65X30MM

CARTILAGE AND BONE INSTRUMENTS



Item Code	Description
06-CBI-06	AIACH FORCEPS, 16CM, 5MM TIP



Item Code	Description
06-CBI-07	DINGMAN CARTILAGE ABRADERS, SET OF TWO



Item Code	Description
06-CBI-12	RUBIN SEPTAL MORSELIZER FORCEPS, 21CM



Item Code	Description
06-CBI-14	RUBIN SEPTAL MORSELIZER FORCEPS, T.C. (TUNGSTEN CARBIDE) 20CM



CARTILAGE AND BONE INSTRUMENTS



Item Code	Description
06-CBI-15	BONE MILL, WITH ASSEMBLING WRENCH

Chisels and Gouges



Item Code	Description
07-CG-01	FREER SEPTUM CHISEL, 15.5CM, 4MM
07-CG-02	FREER SEPTUM CHISEL, 15.5CM, 6MM



Item Code	Description
07-CG-03	BALLENGER SEPTUM CHISEL, 16CM, 4MM
07-CG-04	BALLENGER SEPTUM CHISEL, 16CM, 6MM



Item Code	Description
07-CG-05	KILLIAN NASAL GOUGE, 17.5CM, 6MM



Item Code	Description
07-CG-06	KILLIAN CLAUS NASAL GOUGE, 17CM, 6MM



Chisels and Gouges



Item Code	Description
07-CG-07	COTTLE GUBISCH CHISEL, 18CM, 5MM, GRADUATED, HOLLOW CUT
07-CG-08	COTTLE GUBISCH CHISEL, 18CM, 12MM, GRADUATED, HOLLOW CUT

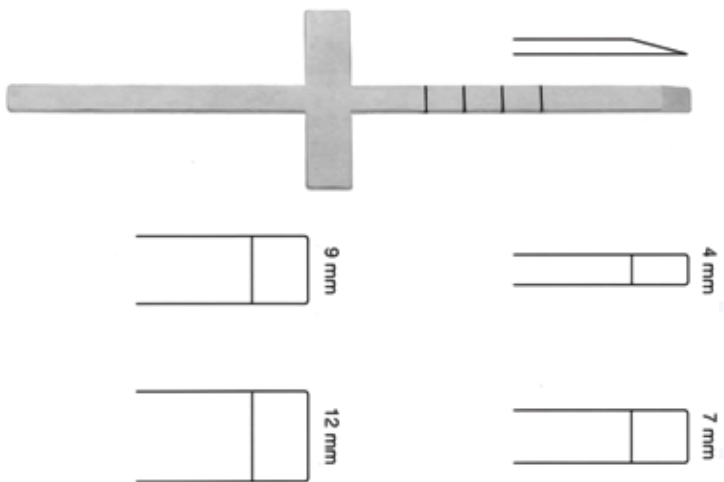

Item Code	Description
07-CG-09	COTTLE CHISEL, 18CM, 4MM, CROSS BAR, GRADUATED
07-CG-10	COTTLE CHISEL, 18CM, 7MM, CROSS BAR, GRADUATED
07-CG-11	COTTLE CHISEL, 18CM, 9MM, CROSS BAR, GRADUATED
07-CG-12	COTTLE CHISEL, 18CM, 12MM, CROSS BAR, GRADUATED

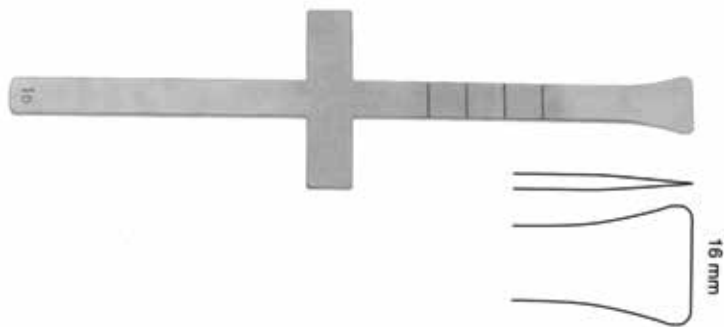

Item Code	Description
07-CG-13	COTTLE CHISEL, 18CM, 16MM, FISHTAIL SHAPED END, CROSSBAR,

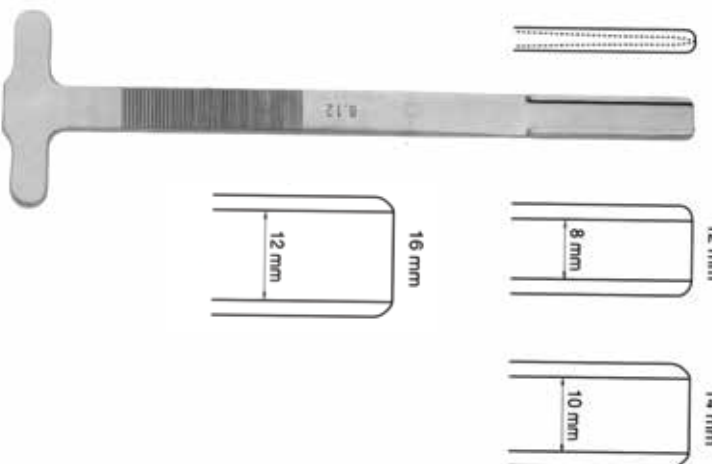

Item Code	Description
07-CG-14	RUBIN EDGED BONE CHISEL, 18CM, 8/12MM, T SHAPE
07-CG-15	RUBIN EDGED BONE CHISEL, 18CM, 10/14MM, T SHAPE
07-CG-16	RUBIN EDGED BONE CHISEL, 18CM, 12/16MM, T SHAPE

Chisels and Gouges



Item Code Description

07-CG-17 WALTER CHISEL/OSTEOTOME, 19CM, 3MM, MODIFIED

07-CG-18 WALTER CHISEL/OSTEOTOME, 19CM, 5MM, MODIFIED

07-CG-19 WALTER CHISEL/OSTEOTOME, 19CM, 12MM, MODIFIED

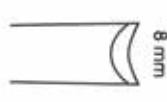
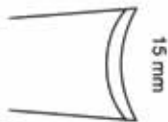
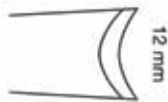

MAIZ
INTERNATIONAL

Item Code Description

07-CG-20 MCINDOE CHISEL, 16CM, 8MM

07-CG-21 MCINDOE CHISEL, 16CM, 10MM

07-CG-22 MCINDOE CHISEL, 16CM, 12MM

07-CG-23 MCINDOE CHISEL, 16CM, 15MM

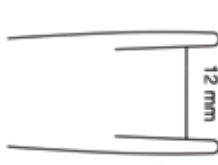
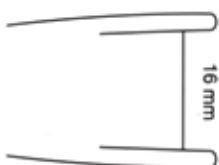

Item Code Description

07-CG-24 MOBERG CHISEL, 18CM, 10MM

07-CG-25 MOBERG CHISEL, 18CM, 12MM

07-CG-26 MOBERG CHISEL, 18CM, 14MM

07-CG-27 MOBERG CHISEL, 18CM, 16MM



Chisels and Gouges



Item Code	Description
07-CG-28	BRAITHWAITE NASAL CHISEL, RIGHT, 5 MM WIDTH, 5 1/2" (140 MM) LENGTH
07-CG-29	BRAITHWAITE NASAL CHISEL, LEFT, 5 MM WIDTH, 5 1/2" (140 MM) LENGTH



Item Code	Description
07-CG-30	CLODIUS BONE CHISEL, 6 MM WIDTH, 8 3/4" (222 MM) LENGTH
07-CG-31	CLODIUS BONE CHISEL, 8 MM WIDTH, 8 3/4" (222 MM) LENGTH
07-CG-32	CLODIUS BONE CHISEL, 10 MM WIDTH, 8 3/4" (222 MM) LENGTH
07-CG-33	CLODIUS BONE CHISEL, 20 MM WIDTH, 8 3/4" (222 MM) LENGTH

Dermatomes



Item Code	Description
09-D-02	Humby Dermatomee Knife, Adjustable, Complete with wooden Box, 32cm



Item Code	Description
09-D-03	SPARE BLADE FOR HUMBY AND WATSON DERMATOME



Item Code	Description
09-D-04	WATSON DERMATOME (SKIN GRAFT KNIFE)



Item Code	Description
09-D-05	SCHINK DERMATOME, 30CM, ADJUSTABLE

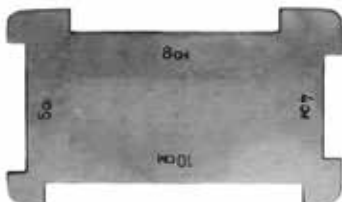

Item Code	Description
09-D-07	SKIN HOLDING/STRETCHING PLATE FOR SCHINK DERMATOME



Item Code	Description
09-D-08	SILVER DERMATOME, 19CM, ADJUSTABLE



Dissectors and Elevators



Item Code	Description
10-D-01	FRONTOTEMPORAL DISSECTOR, 9" (22.5 CM), 5MM TIP, SLIGHTLY CURVED
10-D-02	FRONTOTEMPORAL DISSECTOR, 9" (23 CM), 7MM TIP, SLIGHTLY CURVED
10-D-03	FRONTOTEMPORAL DISSECTOR, 9" (23 CM), 10MM TIP, SLIGHTLY CURVED



Item Code	Description
02-API-03	NAGATA AURICULAR SEPTUM ELEVATOR, 16CM, BLUNT
02-API-04	NAGATA AURICULAR SEPTUM ELEVATOR, 17CM, BLUNT



Item Code	Description
10-D-04	TEMPORAL T DISSECTOR, 9 1/2" (23.5 CM), 12MM TIP, STRAIGHT



Item Code	Description
10-D-05	FRONTOGLABELLAR DISSECTOR, 10 1/2" (26.5 CM), 7MM TIP, S SHAPED

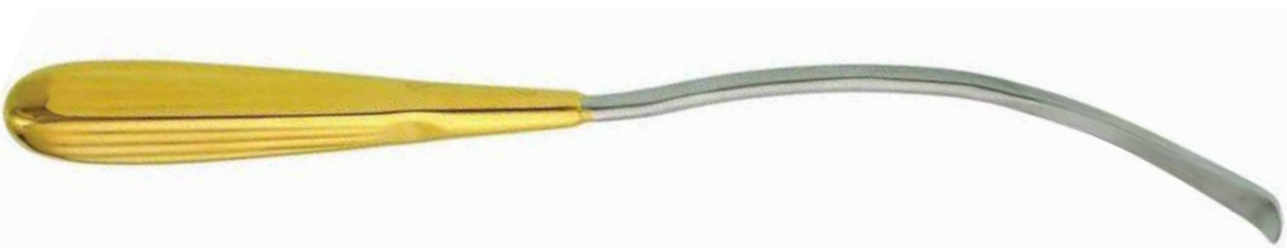

Item Code	Description
10-D-06	ARCUS MARGINALIS DISSECTOR, 9 3/4" (24 CM), 10MM TIP, S SHAPED

Dissectors and Elevators



Item Code	Description
10-D-07	FLAP DISSECTOR, 9 1/2" (23.5 CM), 5MM TIP, STRAIGHT



Item Code	Description
10-D-08	MIDFACE FACIAL DISSECTOR, 9 3/4" (24 CM), MULTIPLE CURVES, 12MM WIDE TIP



Item Code	Description
10-D-09	ORBITAL RIM DISSECTOR, 9" (22.5 CM), SLIGHTLY CURVED



Item Code	Description
10-D-10	TRANSORAL DISSECTOR, 9 3/4" (23.5 CM), CURVED TIP



Item Code	Description
11-E-03	LANGENBECK BONE ELEVATOR, 20CM, 7MM, BLUNT



Item Code	Description
11-E-04	LANGENBECK BONE ELEVATOR, 20CM, 10MM, BLUNT





Dissectors and Elevators



Item Code	Description
11-E-05	LANGENBECK BONE ELEVATOR, 23CM, 10MM, BLUNT, STRONG CURVE

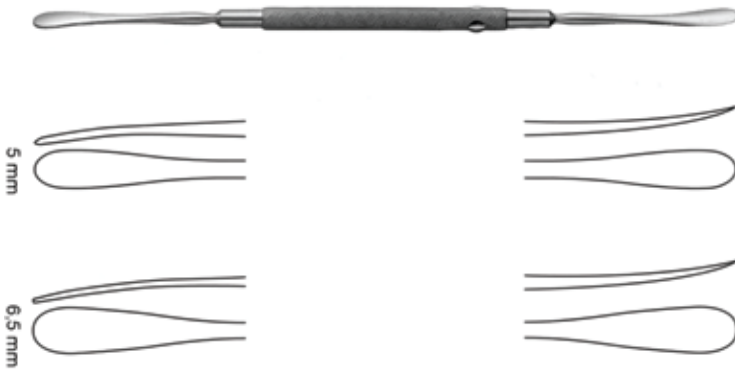

Item Code	Description
11-E-06	FREER PERIOSTEAL ELEVATOR, 19CM, 5MM, DOUBLE ENDED, SHARP / BLUNT
11-E-07	FREER PERIOSTEAL ELEVATOR, 19CM, 6.5MM, DOUBLE ENDED, SHARP / BLUNT



Item Code	Description
11-E-08	COHEN PERIOSTEAL ELEVATOR / RETRACTOR, 24CM, 6MM, DOUBLE ENDED, BLUNT



Item Code	Description
11-E-09	PENNINGTON SEPTUM ELEVATOR, 20CM, DOUBLE ENDED



Dissectors and Elevators



Item Code	Description
11-E-10	YANKAUER SEPTUM ELEVATOR, 18CM, 6MM, BLUNT



Item Code	Description
11-E-11	COTTLE PERIOSTEAL ELEVATOR, 18CM, 8MM, BLUNT



Item Code	Description
11-E-12	BOIES NASAL FRACTURE ELEVATOR, 19CM, 8MM, BLUNT



Item Code	Description
11-E-13	GOLDMAN SEPTUM FRACTURE ELEVATOR, 17CM, 5MM, BLUNT

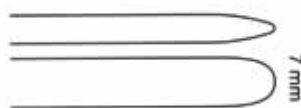

Item Code	Description
11-E-14	NASAL FRACTURE ELEVATOR, 17CM, 7MM, BLUNT



Dissectors and Elevators



Item Code	Description
11-E-15	SUCTION ELEVATOR WITH GUIDE, 21CM, 4MM



Item Code	Description
11-E-17	COTTLE PERIOSTEAL ELEVATOR, 20CM, 2/4MM, DOUBLE ENDED, FINE
11-E-19	COTTLE PERIOSTEAL ELEVATOR, 23CM, 3/4MM, DOUBLE ENDED



Item Code	Description
11-E-18	MASING SEPTUM ELEVATOR, 22CM, 5/5MM, DOUBLE ENDED



Item Code	Description
11-E-20	SCALP ELEVATOR, 9 3/4" (24 CM), 12.5MM TIP, SLIGHTLY CURVED
11-E-21	SCALP ELEVATOR, 9 3/4" (24 CM), 15MM TIP, SLIGHTLY CURVED
11-E-22	SCALP ELEVATOR, 9 3/4" (24 CM), 7MM TIP, STRAIGHT
11-E-23	SCALP ELEVATOR, 9 3/4" (24 CM), 12.5MM TIP, S SHAPED
11-E-24	SCALP ELEVATOR, 9 3/4" (24 CM), 12.5MM TIP, SLIGHTLY CURVED
11-E-25	SCALP ELEVATOR, 9 3/4" (24 CM), 7MM TIP, CURVED TIP
11-E-26	SCALP ELEVATOR, 9 3/4" (24 CM), 7MM TIP, STRONGLY CURVED
11-E-27	SCALP ELEVATOR, 9 3/4" (24 CM), 7MM TIP, SLIGHTLY CURVED

Dissectors and Elevators



Item Code	Description
11-E-28	SCALP ELEVATOR WITH SUCTION, 9 3/4" (24 CM), 7MM WIDE TIP, SLIGHTLY CURVED



Item Code	Description
11-E-29	SCALP ELEVATOR WITH SUCTION, 10 1/2" (26 CM), 8.5 MM WIDE TIP, CURVED TIP



Item Code	Description
11-E-30	PERIOSTEAL ELEVATOR, 10" (25 CM), S SHAPED



Item Code	Description
11-E-31	PERIOSTEAL SPREADER, 9 3/4" (24 CM), 8MM TIP, S SHAPED



Item Code	Description
11-E-32	PERIOSTEAL SPREADER, 9 3/4" (24 CM), 10MM WIDE BLADE, S SHAPED



Dissectors and Elevators



Item Code	Description
11-E-33	ZYGOMATIC ARCH ELEVATOR, 8 1/4" (20.5 CM), STRAIGHT BLADE, 5MM



Item Code	Description
11-E-34	HALLE SEPTUM ELEVATOR, NARROW, 3 MM WIDTH, 7" (178 MM) LENGTH



Item Code	Description
11-E-35	FREER SEPTUM ELEVATOR, DOUBLE ENDED, SHARP / BLUNT, WIDE, 6.5 MM WIDTH, 7 3/4" (197 MM) LENGTH



Item Code	Description
11-E-36	HAJEK BALLENGER SEPTUM ELEVATOR, DOUBLE ENDED, 8.5 MM WIDTH, 7 1/2" (191 MM) LENGTH



Item Code	Description
11-E-37	FREER SEPTUM ELEVATOR, CURVED, DOUBLE ENDED, 5 MM WIDTH, 7 1/2" (191 MM) LENGTH



Item Code	Description
11-E-38	KILLIAN SEPTUM ELEVATOR, DOUBLE ENDED, 4 MM WITH 3.4 MM TAPER, AND 4.3 MM WITH 3 MM TAPER, 7 1/4" (184 MM) LENGTH

Dissectors and Elevators



Item Code	Description
11-E-39	GRUBER COMBINATION KNIFE HANDLE / PERICHONDRIUM ELEVATOR #7, 6 1/2" (165 MM) LENGTH, 10/15C BLADE SIZE



Item Code	Description
11-E-40	HOWARTH SEPTUM ELEVATOR, DOUBLE ENDED, 5 MM WIDTH, 8 1/2" (216 MM) LENGTH



Item Code	Description
11-E-41	KILLIAN SEPTUM ELEVATOR, DOUBLE ENDED, 9" (229 MM) LENGTH, 6 MM WITH 4.5 MM TAPER AND 4.3 MM WITH 3 MM TAPER



Lip and Cheek Retractors



Item Code Description
13-LCR-01 LIP RETRACTOR FOR UPPER JAW, 21CM



Item Code Description
13-LCR-02 LIP RETRACTOR FOR LOWER JAW, 26CM



Item Code Description
13-LCR-03 VESTIBULUM (UNIVERSAL) RETRACTOR,
15CM

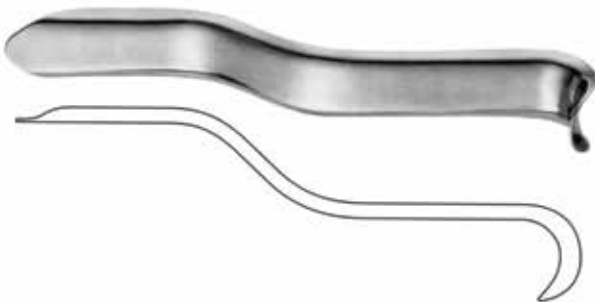

Item Code Description
13-LCR-04 UNIVERSITY OF MINNESOTA CHEEK
RETRACTOR, 15.5CM

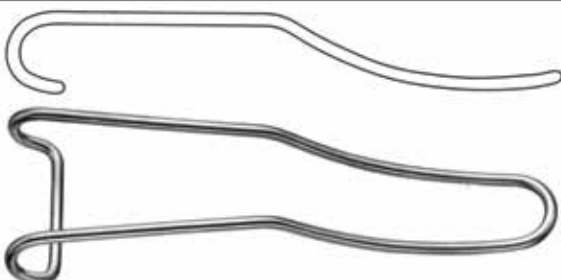

Item Code Description
13-LCR-05 STERNBERG CHEEK RETRACTOR, 14.5CM

Lip and Cleft Palate Instruments



Item Code	Description
14-LCP-01	BLOCKSMA CLEFT PALATE HOOK, 18CM, 1 PRONG
14-LCP-02	BLOCKSMA CLEFT PALATE HOOK, 18CM, 3MM, 2 PRONG

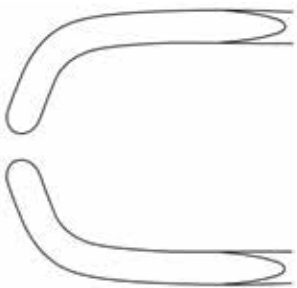

Item Code	Description
14-LCP-03	CLEFT PALATE RASPATORY, 14CM, #1 LEFT
14-LCP-04	CLEFT PALATE RASPATORY, 14CM, #2 RIGHT



Item Code	Description
14-LCP-05	KAHRE CLEFT PALATE RASPATORY, 17CM



Item Code	Description
14-LCP-06	MCINDOE CLEFT PALATE RASPATORY, 16.5CM



Lip and Cleft Palate Instruments

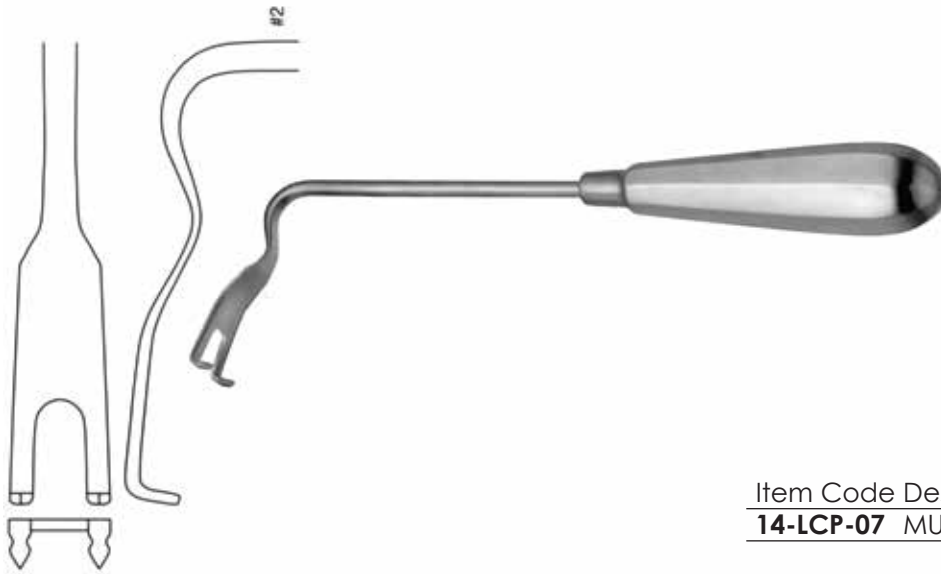

Item Code Description
14-LCP-07 MUCOPERIOSTEAL RETRACTOR, 19CM



Item Code Description
14-LCP-10 WANG CLEFT PALATE ELEVATOR,
15.5CM



Item Code Description
14-LCP-11 WANG CLEFT PALATE ELEVATOR, 18CM,
RIGHT
14-LCP-12 WANG CLEFT PALATE ELEVATOR, 18CM,
LEFT
14-LCP-13 WANG CLEFT PALATE ELEVATOR, 18CM,
RIGHT ANGLED
14-LCP-14 WANG CLEFT PALATE ELEVATOR, 18CM,
LEFT ANGLED

Mallets

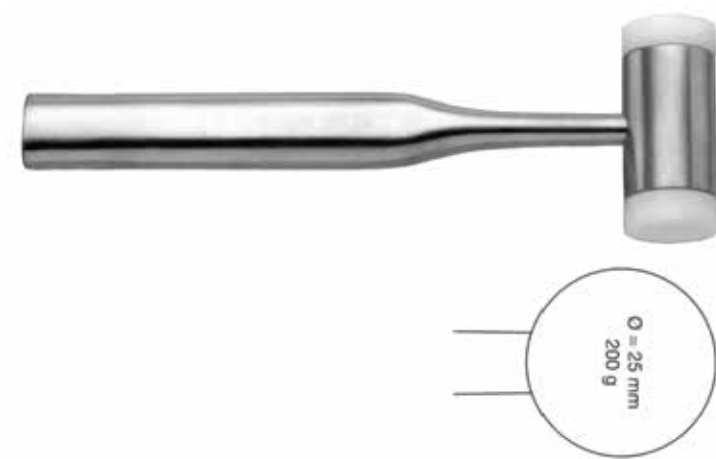

Item Code	Description
15-M-01	MALLET, 18.5CM, PLASTIC FACINGS, 200 GRAMS, 25MM DIAMETER



Item Code	Description
15-M-03	MALLET, 26CM, NOVOTEX PLASTIC, 150 GRAMS, 35MM DIAMETER
15-M-04	MALLET, 26CM, NOVOTEX PLASTIC, 240 GRAMS, 45MM DIAMETER
15-M-05	MALLET, 26CM, NOVOTEX PLASTIC, 330 GRAMS, 50MM DIAMETER



Item Code	Description
15-M-06	COTTLE MALLET, 19CM, 1 PLAIN FACE, 1 CONVEX FACE



Item Code	Description
15-M-07	QUILLEN METAL HAMMER, 24CM, 300 GRAMS, 30MM DIAMETER, ANGLED FACES



Marking And Measuring Instruments



Item Code Description
16-MM-05 MOLTGEN FLEXOMETER, 24CM

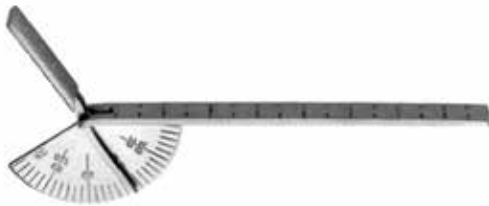

Item Code Description
16-MM-06 FINGER GONIOMETER, 13CM



Item Code Description
16-MM-07 KNOCHEN MESSZIRKEL BONE BOW
SPACER, 19.5CM, SHARP TIPS



Item Code Description
16-MM-10 JAMESON CALIPER, 10CM



Item Code Description
16-MM-11 THORPE CALIPER, 11CM, 80MM
MEASURING RANGE



Marking And Measuring Instruments



Item Code	Description
16-MM-12	CASTROVIEJO CALIPER, 8CM, 20MM MEASURING RANGE



Item Code	Description
16-MM-13	CASTROVIEJO CALIPER, 9CM, 40MM MEASURING RANGE



Item Code	Description
16-MM-14	CASTROVIEJO EPKER CALIPER, 18CM, STRAIGHT, 40MM MEASURING RANGE



Item Code	Description
16-MM-15	CASTROVIEJO EPKER CALIPER, 18CM, ANGLED, 40MM MEASURING RANGE

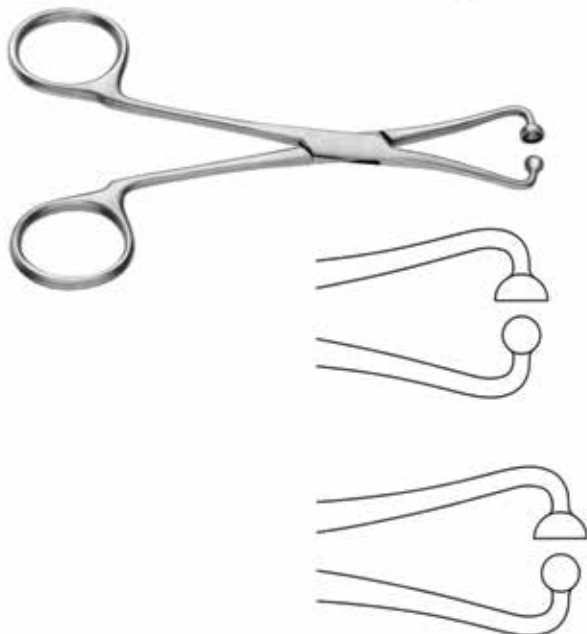

Item Code	Description
16-MM-16	NOSE TIP MARKER, 12CM, STRAIGHT
16-MM-17	NOSE TIP MARKER, 14.5CM, STRAIGHT



Marking And Measuring Instruments



Item Code	Description
16-MM-18	JOSEPH MEASURING ROD, 17CM, GRADUATED IN MILLIMETERS

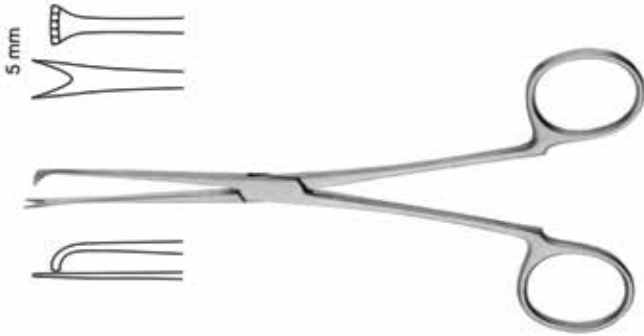

Item Code	Description
16-MM-19	PITANGUY FACELIFT MARKER, 16CM, 5MM WIDE



Item Code	Description
16-MM-34	MARTEN FLAP MARKER, 5 3/4" (14.5 CM)
16-MM-35	MARTEN FLAP MARKER, WITH RATCHET, 5 3/4" (14.5 CM)



Item Code	Description
16-MM-43	D ASSUMPCAO ABDOMINAL FLAP MARKER, 10 MM WIDTH, 10" (254 MM) LENGTH



Item Code	Description
16-MM-44	LOCKWOOD ABDOMINAL DEMARCATOR, 11 MM WIDTH, WITH ANGLED HINGE, 12 1/4" (311 MM) LENGTH

Marking And Measuring Instruments

Maxilla Mobilizer

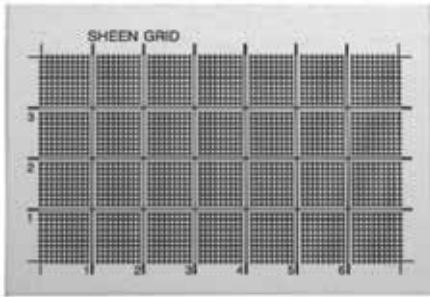

Item Code	Description
16-MM-45	Sheen Grid Stainless Steel, Autoclavable, Grid Dimensions are 40 X 70 mm



Item Code	Description
01-AR-01	ROUND BOWL FOR SOLUTIONS/MARKING COLOR, 60X30MM, 60CC

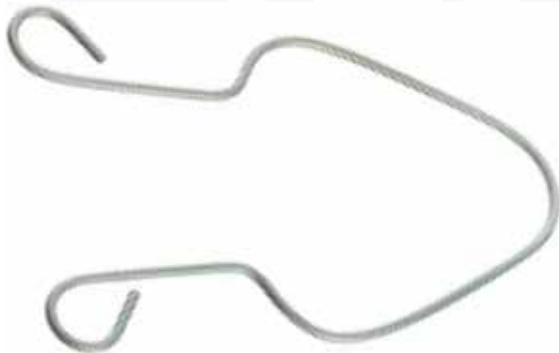

Item Code	Description
01-AR-16	ACKERMAN BREAST MARKER, 5 1/2" (14 CM), SMALL
01-AR-17	ACKERMAN BREAST MARKER, 6 1/4" (16 CM), LARGE



Item Code	Description
01-AR-38	MCKISSOCK KEYHOLE PATTERN, 38 MM DIAMETER, WITH CM MARKINGS
01-AR-39	MCKISSOCK KEYHOLE PATTERN, 42 MM DIAMETER, WITH CM MARKINGS
01-AR-40	MCKISSOCK KEYHOLE PATTERN, 45 MM, DIAMETER, WITH CM MARKINGS

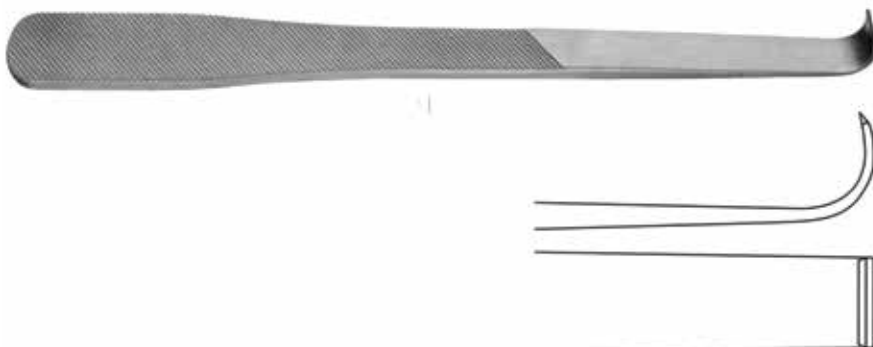

Item Code	Description
17-MM-01	OBWEGESER MAXILLA MOBILIZING INSTRUMENT, 23CM, 12MM



Mouth Gags



Item Code Description

18-MG-01 MOLT MOUTH GAG, 10CM, CHILD SIZE

18-MG-02 MOLT MOUTH GAG, 15CM, ADULT SIZE



Item Code Description

18-MG-03 ROSER KOENIG MOUTH GAG, 16CM



Item Code Description

18-MG-04 DENHART MOUTH GAG, 13CM

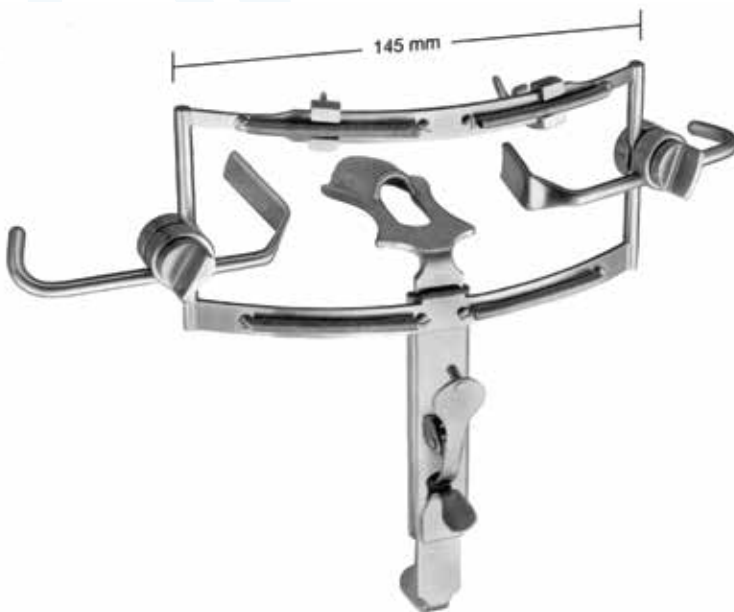

Item Code Description

18-MG-05 DINGMAN MOUTH GAG, COMPLETE

Mucosa Knife and Raspatories

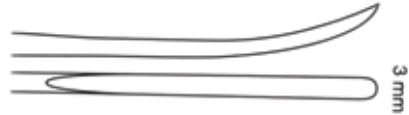

3 mm



5 mm



7 mm

Item Code Description

19-MKR-01 WILLIGER RASPATORY, 16CM, 3MM, SHARP

19-MKR-02 WILLIGER RASPATORY, 16CM, 5MM, SHARP

19-MKR-03 WILLIGER RASPATORY, 16CM, 7MM, SHARP



4 mm

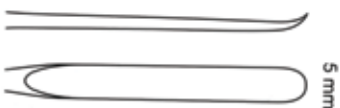

5 mm

ZIMAIZ
CENTRAL

Item Code Description

19-MKR-04 MCKENTY RASPATORY, 15CM, 4MM, SHARP,
LIGHT CURVE

19-MKR-05 MCKENTY RASPATORY, 15CM, 5MM, SHARP,
LIGHT CURVE



Item Code Description

19-MKR-06 FREER MUCOSA END KNIFE, 6" (15 CM)



Rhinoplasty Dressing Forceps



Item Code	Description
20-NDF-01	HARTMANN NASAL DRESSING FORCEPS, 16CM



Item Code	Description
20-NDF-03	WESTMACOTT NASAL DRESSING FORCEPS, 20CM, STANDARD
20-NDF-04	WESTMACOTT NASAL DRESSING FORCEPS, 20CM, DELICATE



Item Code	Description
20-NDF-05	LUBET BARBON NASAL DRESSING FORCEPS, 20CM



Rhinoplasty Files and Rasps

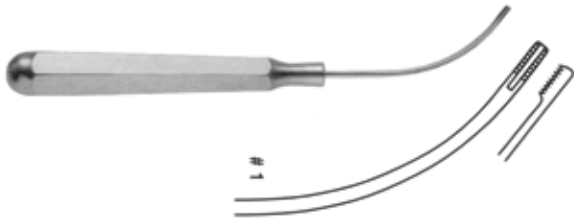

#1



#2

Item Code Description

21-NFR-01 DINGMAN CARTILAGE ABRADERS, SET OF TWO

21-NFR-02 DINGMAN CARTILAGE ABRADER #1, 15CM, CURVED LEFT

21-NFR-03 DINGMAN CARTILAGE ABRADER #2, 15CM, CURVED RIGHT

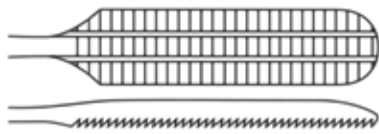

Item Code Description

21-NFR-04 MALTZ NASAL RASP, 18.5CM

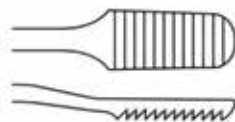

Item Code Description

21-NFR-05 LEWIS NASAL RASP, 20CM

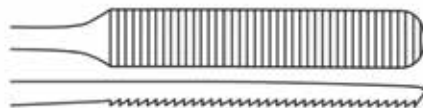

Item Code Description

21-NFR-06 COTTLE NASAL RASP, 21CM

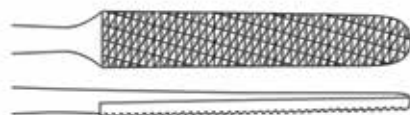

Item Code Description

21-NFR-07 COTTLE T.C. NASAL RASP, 20.5CM



Rhinoplasty Files and Rasps

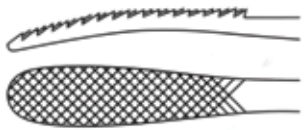
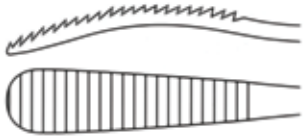
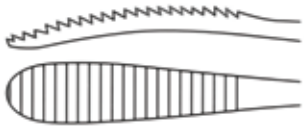

Item Code Description

21-NFR-08 AUFRICHT NASAL RASP, 21CM, CROSS CUT

21-NFR-09 AUFRICHT NASAL RASP, 21CM, DOWN

21-NFR-10 AUFRICHT NASAL RASP, 21CM, UP

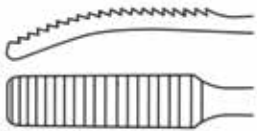

Item Code Description

21-NFR-11 NASAL RASP, 19.5CM, UP

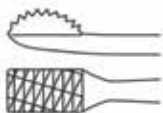

Item Code Description

21-NFR-12 LEWIS T.C. NASAL RASP, 19.5CM

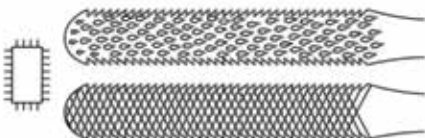

Item Code Description

21-NFR-13 FOMON BONE AND NASAL RASP, 20CM

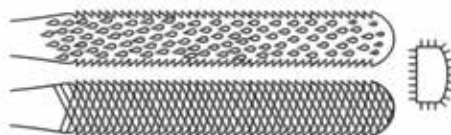

Rhinoplasty Files and Rasps

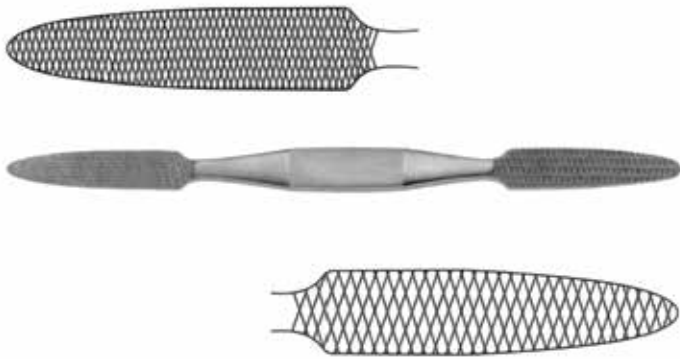

Item Code	Description
21-NFR-14	CONVERSE BONE AND NASAL FILE, 18.5CM

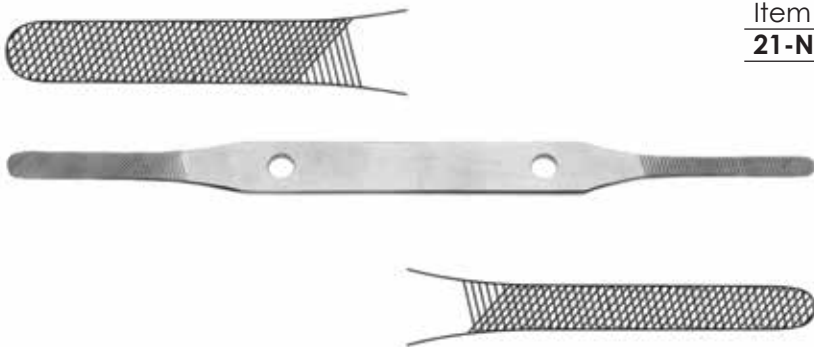

Item Code	Description
21-NFR-15	MASING NASAL FILE, 21CM, FINE

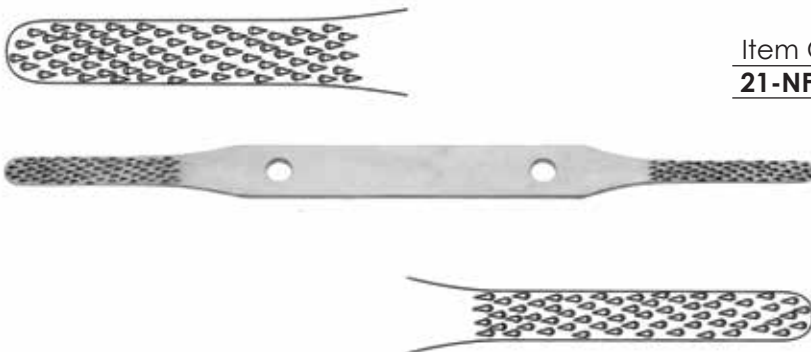

Item Code	Description
21-NFR-16	MASING NASAL RASP, 21CM, COARSE

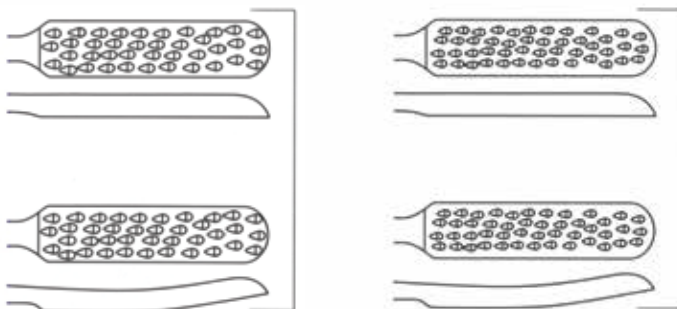

Item Code	Description
21-NFR-17	OBWEGESER NASAL RASP, 19.5CM, FLAT, FINE, DELICATE PATTERN
21-NFR-18	OBWEGESER NASAL RASP, 19.5CM, FLAT, MEDIUM FINE
21-NFR-19	OBWEGESER NASAL RASP, 19.5CM, CONVEX, FINE, DELICATE PATTERN
21-NFR-20	OBWEGESER NASAL RASP, 19.5CM, CONVEX, MEDIUM FINE
21-NFR-21	OBWEGESER NASAL RASP, 19.5CM, V SHAPED, FINE, DELICATE PATTERN
21-NFR-22	OBWEGESER NASAL RASP, 19.5CM, V SHAPED, MEDIUM FINE



Rhinoplasty Files and Rasps

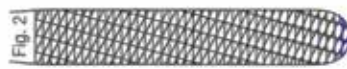
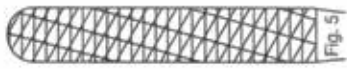

Item Code	Description
21-NFR-23-01	GUBISCH FOMON T.C. NASAL RASP, 20CM, #1 and #2
21-NFR-23-02	GUBISCH FOMON T.C. NASAL RASP, 20CM, #3 and #4
21-NFR-23-03	GUBISCH FOMON T.C. NASAL RASP, 20CM, #5 and #6
21-NFR-23-04	GUBISCH FOMON T.C. NASAL RASP, 20CM, #7 and #8
21-NFR-23-05	GUBISCH FOMON T.C. NASAL RASP, 20CM, #9 and #10



ZIMAIZ
INTERNATIONAL

Rhinoplasty Forceps

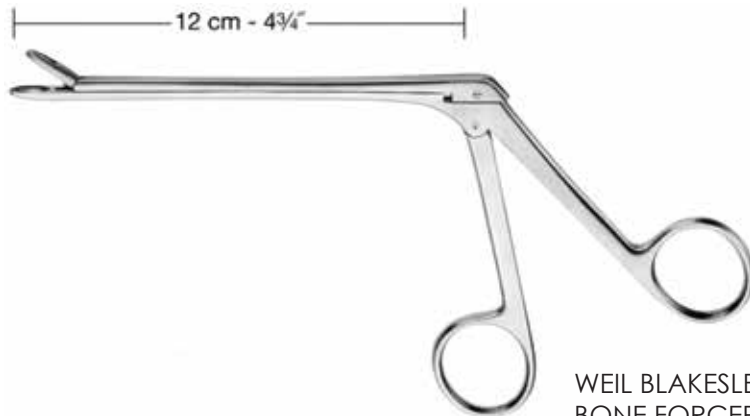

WEIL BLAKESLEY WILDE ETHMOID BONE FORCEP

NORMAL SHAFT



3,0 mm		22-NF-01	22-NF-09	22-NF-16
3,6 mm		22-NF-02	22-NF-10	22-NF-17
4,2 mm		22-NF-03	22-NF-11	22-NF-18
4,8 mm		22-NF-04	22-NF-12	22-NF-19
5,6 mm		22-NF-05		

SLIM SHAFT



3,0 mm		22-NF-23	22-NF-28
3,6 mm		22-NF-24	22-NF-29
4,2 mm		22-NF-25	22-NF-30
4,8 mm		22-NF-26	22-NF-31
5,6 mm		22-NF-27	



Rhinoplasty Forceps

11,5 cm - 4½"



WEIL BLAKESLEY FORCEPS,
THROUGH CUT



45°

2,0 mm 

22-NF-06

22-NF-13

2,5 mm 

22-NF-07

22-NF-14

3,0 mm 

22-NF-08

22-NF-15



ZIMAIZ
INTERNATIONAL

Rhinoplasty Retractors



Item Code	Description
23-NR-01	COTTLE DOUBLE HOOK, 15CM, SHARP, 3X4MM

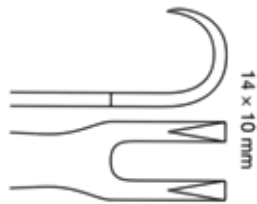

Item Code	Description
23-NR-02	KILNER DOUBLE NASAL HOOK, 10CM, SHARP, 14X10MM



Item Code	Description
23-NR-03	GUBISCH KILNER DOUBLE NASAL HOOK (ALAR RETRACTOR), 8CM, SHARP, 5X10MM



Item Code	Description
23-NR-04	CONVERSE ALAR RETRACTOR, 12CM, DOUBLE ENDED, 7X10MM AND 7X14MM



Item Code	Description
23-NR-05	COTTLE ALAR AND SKIN HOOK, 14CM, 2 PRONGS, SHARP, 5X10MM



Item Code	Description
23-NR-08	MILLARD COTTLE RETRACTOR WITH FINGER RING, 5.5CM, DOUBLE PRONG, SHARP, 5X12MM



Rhinoplasty Retractors

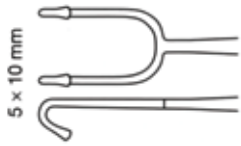

Item Code Description

23-NR-09 FOMON RETRACTOR, 17CM, BALL TIPS, 5X10MM



Item Code Description

23-NR-10 COTTLE RETRACTOR, 15CM, 4 PRONGS, BLUNT, 10X10MM

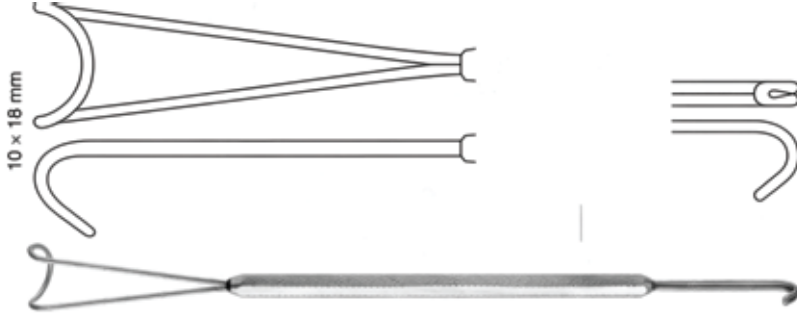

Item Code Description

23-NR-11 MASING RETRACTOR, 20CM, WITH GUIDE CHANNEL, 10X18MM

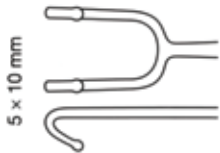

Item Code Description

23-NR-12 NEIVERT RETRACTOR, 19CM, DOUBLE ENDED, WITH GUIDE CHANNEL, 5X10MM



Item Code Description

23-NR-13 COTTLE NEIVERT RETRACTOR, 21CM, DOUBLE ENDED, 5X10MM

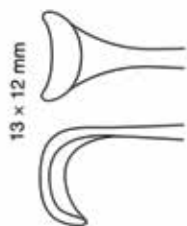

Item Code Description

23-NR-14 COTTLE ALAR RETRACTOR, 14CM, 13X12MM

Rhinoplasty Retractors

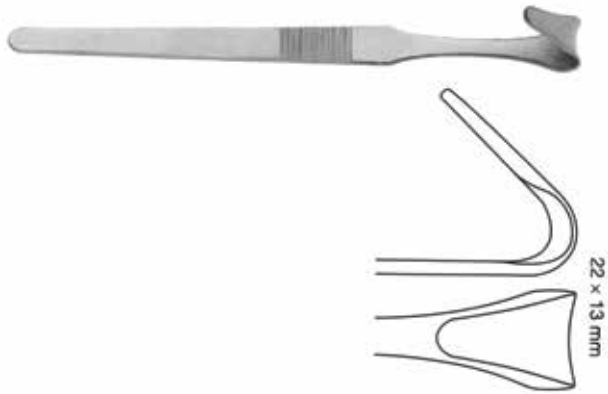

Item Code	Description
23-NR-15	COTTLE ALAR RETRACTOR, 15CM, 22X13MM

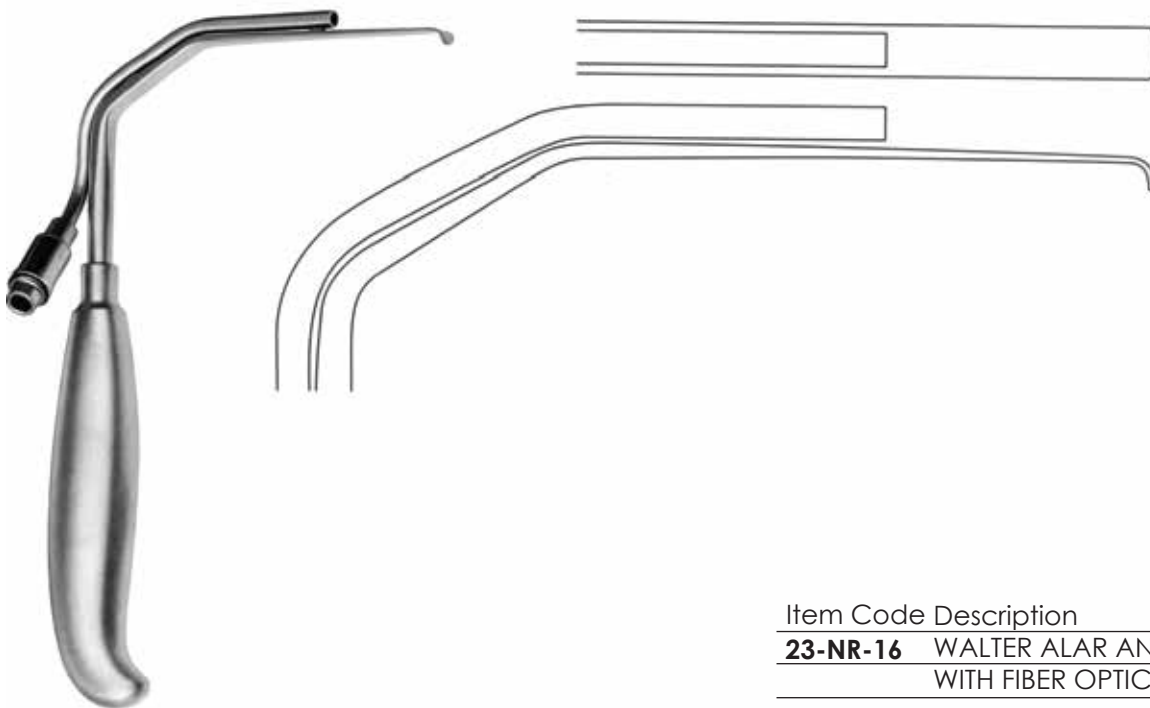

Item Code	Description
23-NR-16	WALTER ALAR AND NASAL RETRACTOR WITH FIBER OPTIC ILLUMINATION, 18.5CM

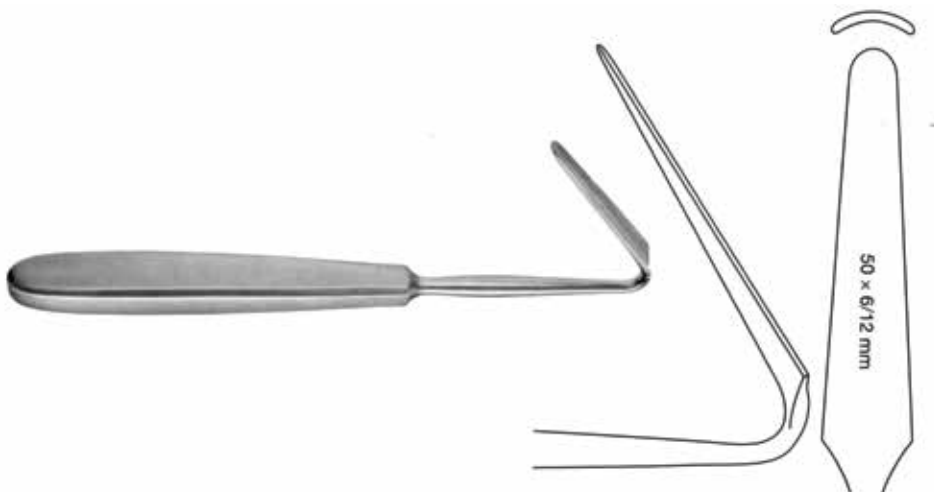

Item Code	Description
23-NR-17	GUBISCH AUFRICHT NASAL RETRACTOR, 17CM, 50X6-12MM



Rhinoplasty Retractors

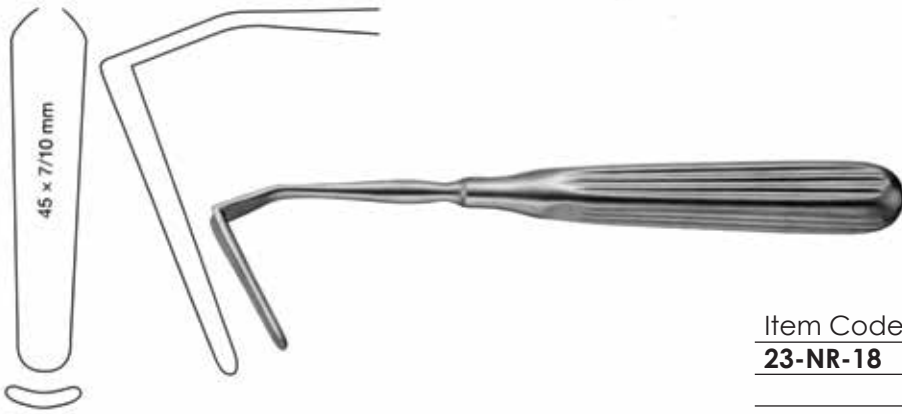

Item Code	Description
23-NR-18	AUFRICT NASAL RETRACTOR, 18CM, 45X7-10MM

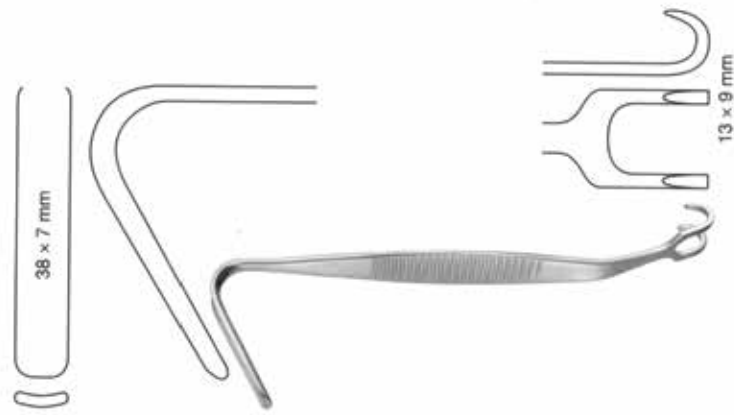

Item Code	Description
23-NR-19	AUFRICT NASAL RETRACTOR, 13.5CM, DOUBLE ENDED, BLUNT, 38X7MM

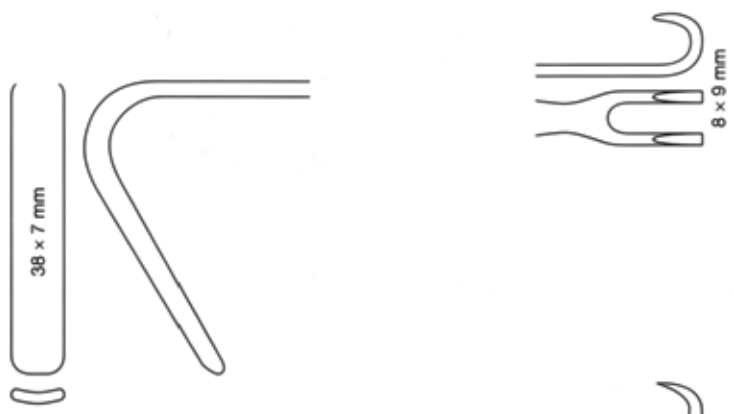

Item Code	Description
23-NR-21	AUFRICT WALTER NASAL RETRACTOR, 13.5CM, DOUBLE ENDED, BLUNT, 38X7MM

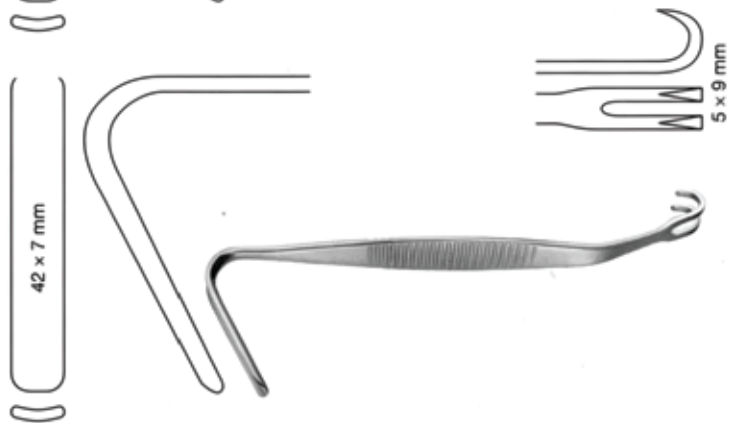

Item Code	Description
23-NR-20	AUFRICT WALTER NASAL RETRACTOR, 13.5CM, DOUBLE ENDED, SHARP, 42X7MM

Rhinoplasty Retractors



Item Code	Description
23-NR-22	AUFRICHT NASAL RETRACTOR, 6 1/4" (16CM), 7MM TIP, 45MM BLADE, WITH FIBER OPTIC LIGHT GUIDE
23-NR-24	AUFRICHT NASAL RETRACTOR, 7" (18CM), 10MM TIP, 45MM BLADE, WITH FIBER OPTIC LIGHT GUIDE



Item Code	Description
23-NR-26	CONVERSE BLADE NASAL RETRACTOR, 20MM X 10MM WIDE, WITH FIBER OPTIC LIGHT GUIDE
23-NR-27	CONVERSE BLADE NASAL RETRACTOR, 30MM X 12MM WIDE, WITH FIBER OPTIC LIGHT GUIDE
23-NR-28	CONVERSE BLADE NASAL RETRACTOR, 40MM X 12MM WIDE, WITH FIBER OPTIC LIGHT GUIDE
23-NR-29	CONVERSE BLADE NASAL RETRACTOR, 50MM X 12MM WIDE, WITH FIBER OPTIC LIGHT GUIDE



Item Code	Description
23-NR-34	FOMON NASAL RETRACTOR, 1 BALL END PRONG, 6 1/4" (16 CM)
23-NR-35	FOMON NASAL RETRACTOR, 2 BALL END PRONGS, 6 1/4" (16 CM)



Item Code	Description
R-09-58	Killian Nasal Speculum With Fiber Optics Illumination



Rhinoplasty Saws



Item Code Description

24-NS-01 JOSEPH NASAL SAW, 17CM, STRAIGHT



Item Code Description

24-NS-02 JOSEPH NASAL SAW, 17CM, LEFT

24-NS-03 JOSEPH NASAL SAW, 17CM, RIGHT

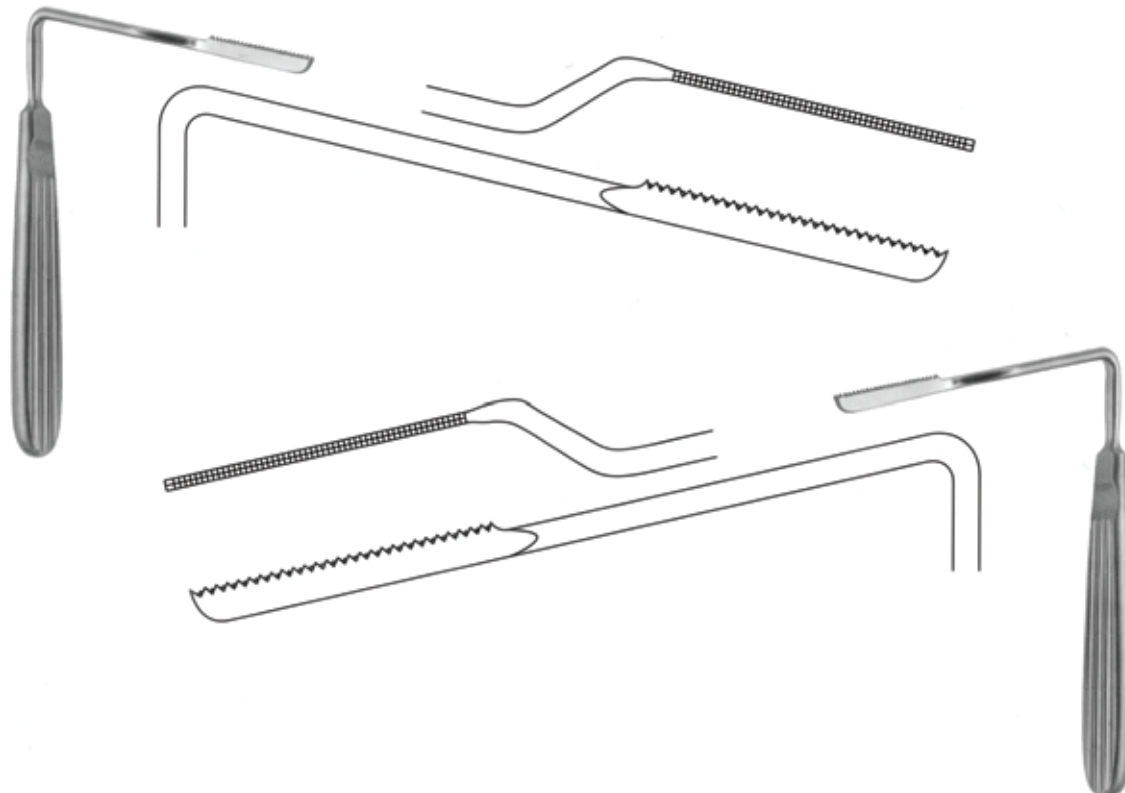

Item Code Description

24-NS-04 JOSEPH NASAL SAW, ANGLED TO LEFT

24-NS-05 JOSEPH NASAL SAW, ANGLED TO RIGHT

Rhinoplasty Septum Forceps



Item Code	Description
25-NSF-01	LUC BRUENINGS HEYMANN ETHMOID FORCEPS 18CM



Item Code	Description
25-NSF-03	CRAIG VOMER FORCEPS, 17CM



Item Code	Description
25-NSF-04	CRAIG DOMNICK SEPTUM FORCEPS, 17CM, CURVED RIGHT
25-NSF-05	CRAIG DOMNICK SEPTUM FORCEPS, 17CM, CURVED LEFT



Item Code	Description
25-NSF-07	OBWEGESER NASAL SEPTUM CUTTER / PERFORATION FORCEPS, 18.5CM



Rhinoplasty Specula



Item Code Description

26-NS-01 TIECK HALLE NASAL SPECULUM,
13.5CM, FOR BABIES

26-NS-02 TIECK HALLE NASAL SPECULUM,
13.5CM, FOR INFANTS



ZIMAIZ
INTERNATIONAL

Item Code Description

26-NS-03 HARTMANN NASAL SPECULUM #1, 15CM

26-NS-04 HARTMANN NASAL SPECULUM #2, 15CM

26-NS-05 HARTMANN NASAL SPECULUM #3, 15CM



Item Code Description

26-NS-06 VIENNA MODEL (MODIFIED WIEN)
STANDARD NASAL SPECULUM #1, 14CM

26-NS-07 VIENNA MODEL (MODIFIED WIEN)
STANDARD NASAL SPECULUM #2, 14CM

26-NS-08 VIENNA MODEL (MODIFIED WIEN)
STANDARD NASAL SPECULUM #3, 14CM

Rhinoplasty Specula



Item Code Description

26-NS-09	KILLIAN NASAL SPECULUM #1, 14CM, 35MM
26-NS-10	KILLIAN NASAL SPECULUM #2, 14CM, 50MM
26-NS-11	KILLIAN NASAL SPECULUM #3, 14CM, 75MM
26-NS-12	KILLIAN NASAL SPECULUM #4, 14CM, 90MM

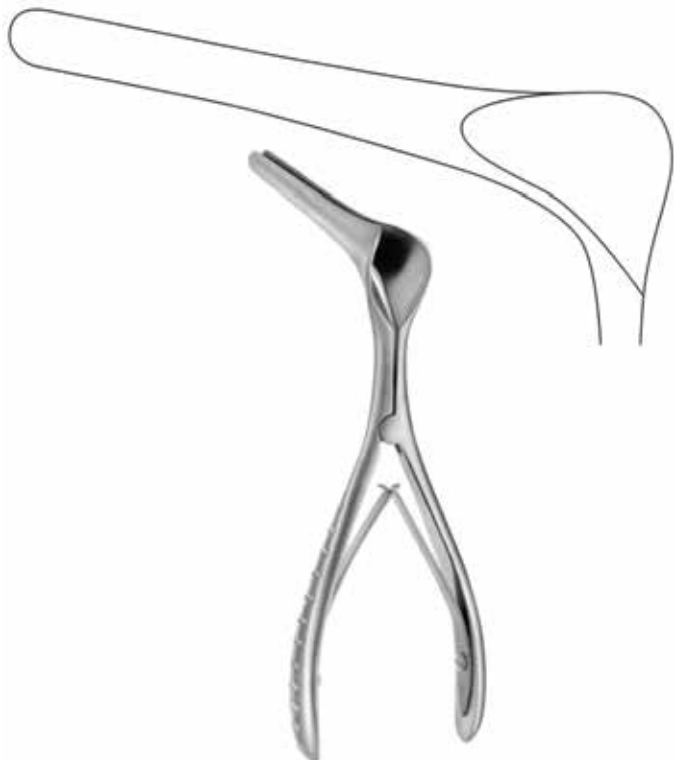

MAIZ
INTERNATIONAL

Item Code Description

26-NS-13	KILLIAN ASEPT NASAL SPECULUM, #4, 90MM (MODIFIED)
-----------------	---



Item Code Description

26-NS-20	COTTLE COLUMELLA FORCEPS, 11CM
-----------------	--------------------------------



Rhinoplasty Specula



Item Code Description

26-NS-14 COTTLE NASAL SPECULUM #1, 14CM, 35MM

26-NS-15 COTTLE NASAL SPECULUM #2, 14CM, 55MM

26-NS-16 COTTLE NASAL SPECULUM #3, 14CM, 75MM

26-NS-17 COTTLE NASAL SPECULUM #4, 14CM, 90MM



ZIMAIZ
INTERNATIONAL

Item Code Description

26-NS-18 COTTLE NASAL SEPTUM SPECULUM, 14CM,
50MM



Item Code Description

26-NS-19 COTTLE NASAL SPECULUM, DELICATE,
15CM, 55MM

Rhinoplasty Knives

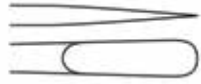

Item Code	Description
29-RK-01	COTTLE NASAL KNIFE, 14CM, STRAIGHT



Item Code	Description
29-RK-02	JOSEPH NASAL KNIFE, 15CM, STRAIGHT, BUTTON END



Item Code	Description
29-RK-03	CONVERSE RHINOPLASTY KNIFE, 15CM, CURVED, BUTTON END



Item Code	Description
29-RK-04	COTTLE DOUBLE EDGED KNIFE, 15CM, STRAIGHT



Item Code	Description
29-RK-05	JOSEPH DOUBLE EDGED KNIFE, 15CM, CURVED, SHARP TIP



Item Code	Description
29-RK-06	JOSEPH BUTTON END KNIFE, 16CM, ANGLED



Rhinoplasty Scissors



Item Code	Description
30-RS-01-01	HEYMANN NASAL SCISSORS, SUPERCUT, 17CM
30-RS-01-02	HEYMANN NASAL SCISSORS, SUPERCUT, 18CM
30-RS-01-03	HEYMANN NASAL SCISSORS, SUPERCUT, 20CM

ZIMAIZ
INTERNATIONAL

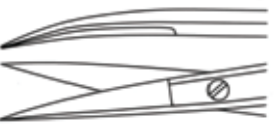
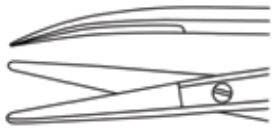

Item Code	Description
30-RS-05-01	COTTLE MASING RHINOPLASTY SCISSORS, 10CM, CURVED BLADE, SHARP
30-RS-05-02	COTTLE MASING RHINOPLASTY SCISSORS, 10CM, CURVED BLADE, BLUNT

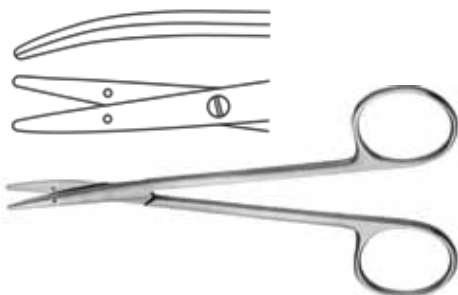

Item Code	Description
30-RS-07	LITTLER SUTURE CARRYING SCISSORS, 12CM

Rhinoplasty Scissors



Item Code	Description
30-RS-08	COTTLE BULLDOG SCISSORS, 11.5CM

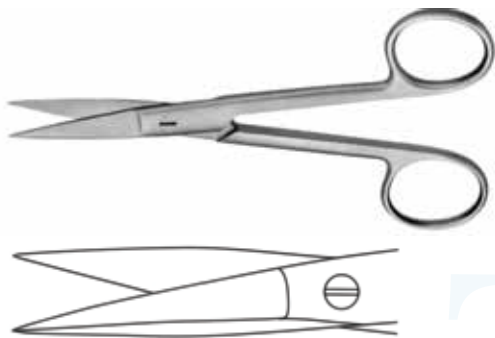

Item Code	Description
30-RS-09	CONVERSE SCISSORS, 13.5CM, DOUBLE EDGED, OUTER EDGES SEMI SHARP

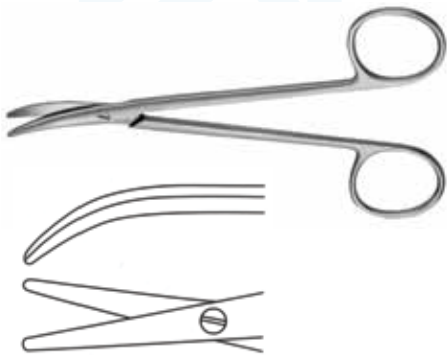

Item Code	Description
30-RS-10	CINELLI RHINOPLASTY SCISSORS, 11CM, OUTER EDGES SEMI SHARP

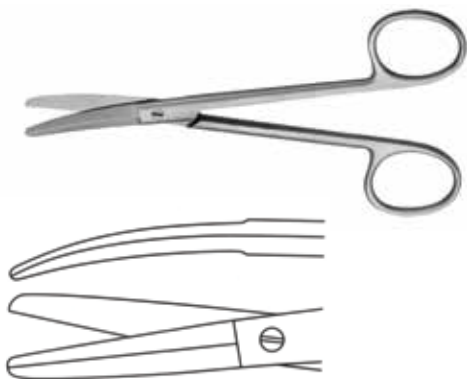

Item Code	Description
30-RS-11	FOMON RHINOPLASTY SCISSORS, 12.5CM, WITH OUTER CUTTING, BOTH SIDES SHARP



Rhinoplasty Scissors

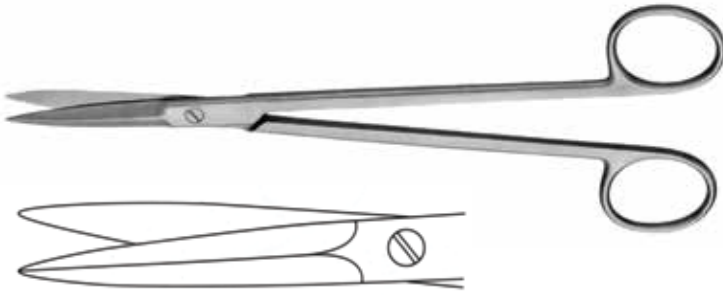

Item Code	Description
30-RS-12	MCINDOE RHINOPLASTY SCISSORS, 19CM, STRAIGHT, SERRATED

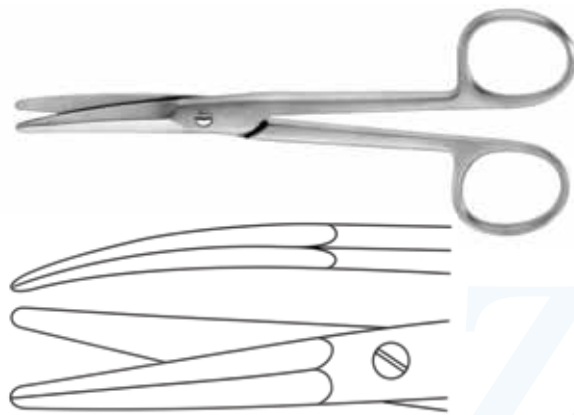

Item Code	Description
30-RS-13-01	AUFRICHT NASAL SCISSORS, 14CM, BLUNT
30-RS-13-02	AUFRICHT NASAL SCISSORS, 14CM, BLUNT, SUPERCUT
30-RS-13-03	AUFRICHT NASAL SCISSORS, 14CM, BLUNT, TC (TUNGSTEN CARBIDE)
30-RS-13-04	AUFRICHT NASAL SCISSORS, 14CM, BLUNT, SUPERCUT PLUS



Item Code	Description
30-RS-17-01	FOMON RHINOPLASTY SCISSORS, 12CM
30-RS-17-02	FOMON RHINOPLASTY SCISSORS SUPERCUT, 12CM,

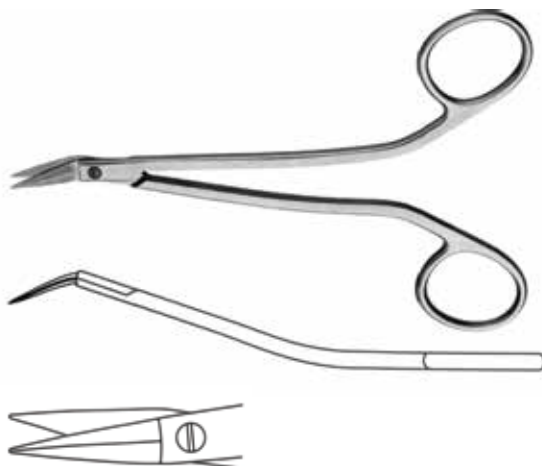

Item Code	Description
30-RS-19	WALTER DORSAL SCISSORS SUPERCUT, 14CM, ANGULAR

Rhinoplasty Scissors

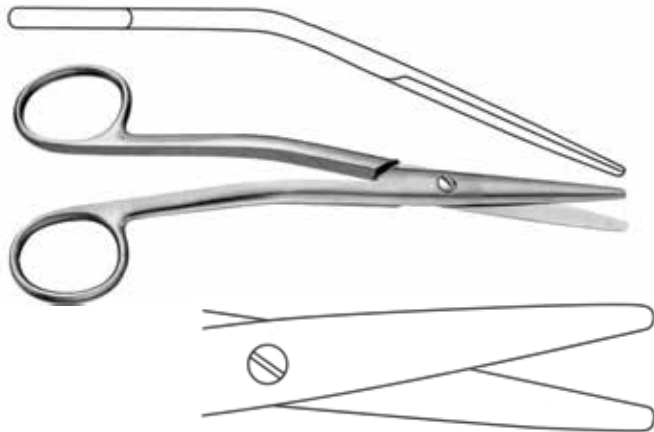

Item Code	Description
30-RS-20-01	COTTLE DORSAL SCISSORS, 16CM, ANGULAR
30-RS-20-02	COTTLE DORSAL SCISSORS, 16CM, ANGULAR, SUPERCUT
30-RS-20-03	COTTLE DORSAL SCISSORS, 16CM, ANGULAR, TC (TUNGSTEN CARBIDE)
30-RS-20-04	COTTLE DORSAL SCISSORS, 16CM, ANGULAR, SUPERCUT PLUS

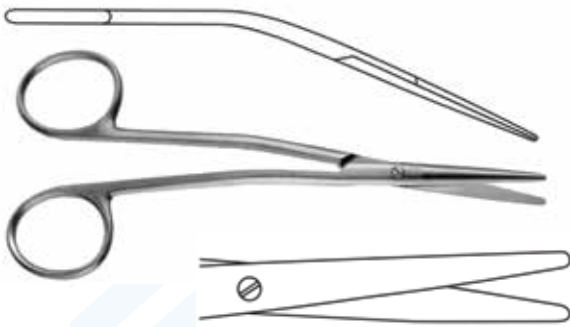

Item Code	Description
30-RS-24-01	FOMON DORSAL SCISSORS, 13CM, ANGULAR
30-RS-24-02	FOMON DORSAL SCISSORS, 13CM, ANGULAR, SUPERCUT
30-RS-24-03	FOMON DORSAL SCISSORS, 13CM, ANGULAR, TC (TUNGSTEN CARBIDE)
30-RS-24-04	FOMON DORSAL SCISSORS, 13CM, ANGULAR, SUPERCUT PLUS

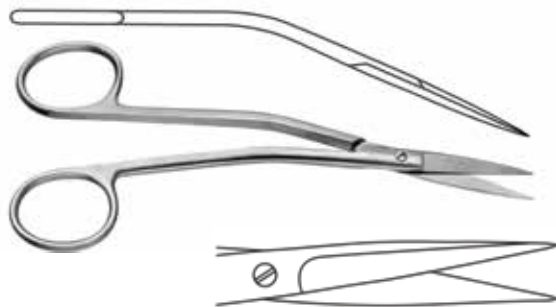

Item Code	Description
30-RS-27-01	FANOUS DORSAL SCISSORS, 14CM
30-RS-27-02	FANOUS DORSAL SCISSORS, 14CM, SUPERCUT

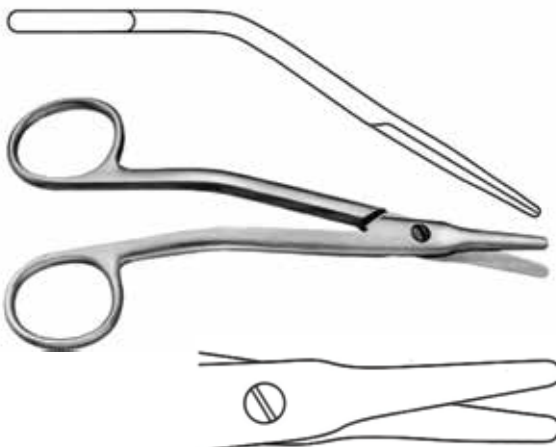

Item Code	Description
30-RS-29-01	WALTER COTTLE DORSAL SCISSORS, 16CM, CURVED
30-RS-29-02	WALTER COTTLE DORSAL SCISSORS, 16CM, CURVED, SUPERCUT
30-RS-29-03	WALTER COTTLE DORSAL SCISSORS, 16CM, CURVED, (TUNGSTEN CARBIDE)
30-RS-29-04	WALTER COTTLE DORSAL SCISSORS, 16CM, CURVED, SUPERCUT PLUS



Rhinoplasty Scissors

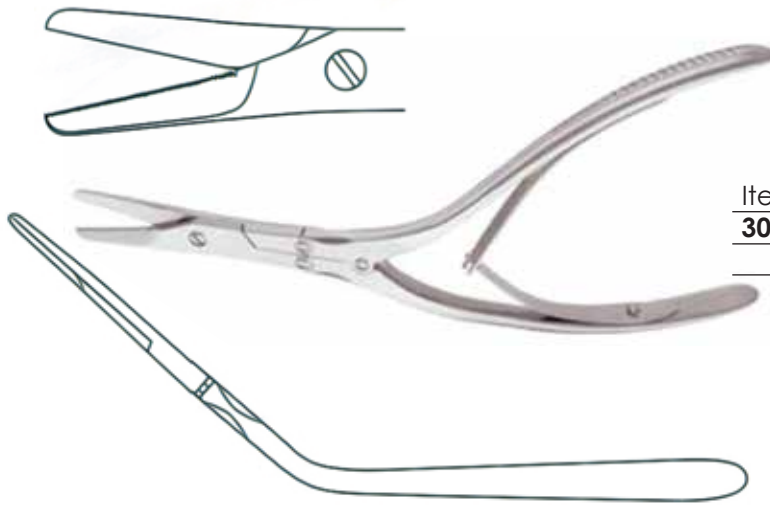

Item Code Description

30-RS-31 CAPLAN NASAL SEPTUM SCISSORS, 20CM,
SERRATED



Item Code Description

30-RS-32 GIUNTA T.C. NASAL SCISSORS, 13.5CM,
CURVED

Septum Straightening Forceps



Item Code	Description
31-SSF-01	WALSHAM UNIVERSAL SEPTUM FORCEPS, 23CM

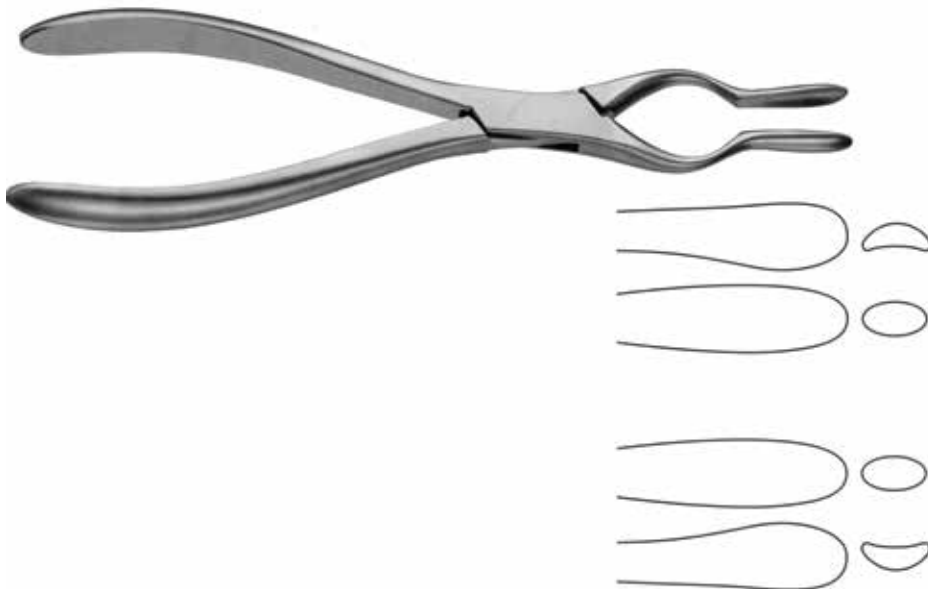

Item Code	Description
31-SSF-02	WALSHAM SEPTUM STRAIGHTENING FORCEPS, 23CM, RIGHT
31-SSF-03	WALSHAM SEPTUM STRAIGHTENING FORCEPS, 23CM, LEFT

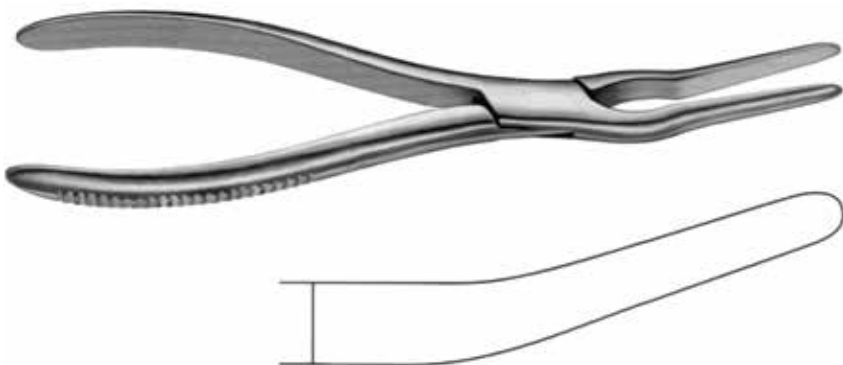

Item Code	Description
31-SSF-06	ASCH SEPTUM STRAIGHTENING FORCEPS, 22CM, ANGLED



Septum Straightening Forceps

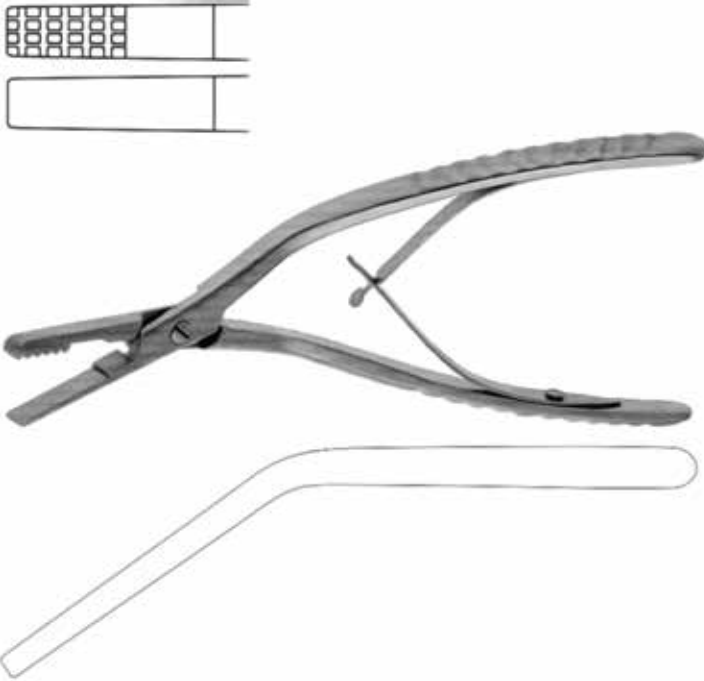

Item Code	Description
25-NSF-07	OBWEGESER NASAL SEPTUM CUTTER / PERFORATION FORCEPS, 18.5CM



Osteotomes and Raspatories



9 mm

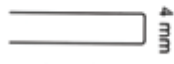

4 mm



12 mm

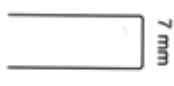

7 mm

Item Code	Description
27-O-01	COTTLE OSTEOTOME, 18CM, 4MM, STRAIGHT, GRADUATED
27-O-02	COTTLE OSTEOTOME, 18CM, 7MM, STRAIGHT, GRADUATED
27-O-03	COTTLE OSTEOTOME, 18CM, 9MM, STRAIGHT, GRADUATED
27-O-04	COTTLE OSTEOTOME, 18CM, 12MM, STRAIGHT, GRADUATED



3 mm

Item Code	Description
27-O-05	GUBISCH OSTEOTOME, 18.5CM, 3MM, ALUMINIUM HANDLE



16 mm

Item Code	Description
27-O-06	COTTLE OSTEOTOME, 18CM, 16MM, FISHTAIL SHAPED END, STRAIGHT, GRADUATED



10 mm



14 mm

Item Code	Description
27-O-07	RUBIN NASAL OSTEOTOME, 18CM, 10MM
27-O-08	RUBIN NASAL OSTEOTOME, 18CM, 14MM



Osteotomes and Raspatories



Item Code	Description
27-O-09	COTTLE OSTEOTOME, 18CM, 6MM, CURVED, GRADUATED



Item Code	Description
27-O-10	COTTLE BONE LEVER/SPLITTING OSTEOTOME, 20CM, 10MM



Item Code	Description
27-O-11	GUBISCH FANOUS NASAL OSTEOTOME, 19.5CM, NARROW, DELICATE, WITH GUIDE THORN

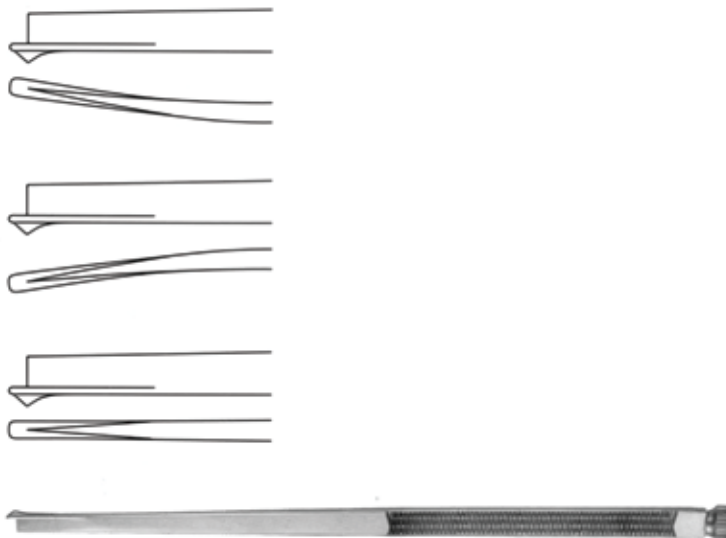

Item Code	Description
27-O-12	FANOUS OSTEOTOME, 19.5CM, 4MM, STRAIGHT, WITH GUIDE THORN
27-O-13	FANOUS OSTEOTOME, 19.5CM, 4MM, LEFT, WITH GUIDE THORN
27-O-14	FANOUS OSTEOTOME, 19.5CM, 4MM, RIGHT, WITH GUIDE THORN

Osteotomes and Raspatories



9 mm



12 mm



6 mm



2 mm



3 mm



4 mm



7 mm

Item Code	Description
27-O-15	WALTER OSTEOTOME, 19CM, 2MM
27-O-16	WALTER OSTEOTOME, 19CM, 3MM
27-O-17	WALTER OSTEOTOME, 19CM, 4MM
27-O-18	WALTER OSTEOTOME, 19CM, 7MM
27-O-19	WALTER OSTEOTOME, 19CM, 9MM
27-O-20	WALTER OSTEOTOME, 19CM, 12MM
27-O-21	WALTER OSTEOTOME, 19CM, 6MM, CURVED



5 mm



7 mm



8 mm

Item Code	Description
27-O-22	FOMON OSTEOTOME, 17CM, 5MM, STRAIGHT
27-O-23	FOMON OSTEOTOME, 17CM, 7MM, STRAIGHT
27-O-24	FOMON OSTEOTOME, 17CM, 8MM, STRAIGHT



Osteotomes and Raspatories

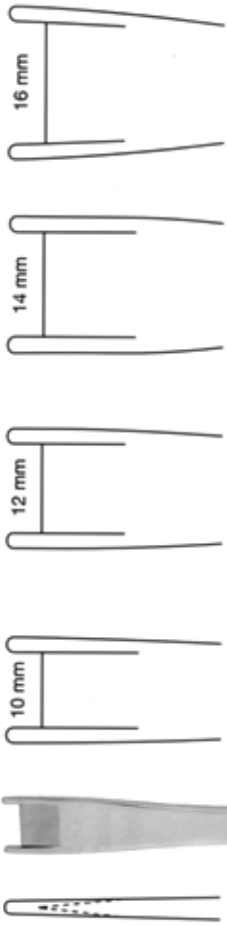

Item Code	Description
27-O-25	CINELLI GUARDED OSTEOTOME, 16CM, 10MM, STRAIGHT
27-O-26	CINELLI GUARDED OSTEOTOME, 16CM, 12MM, STRAIGHT
27-O-27	CINELLI GUARDED OSTEOTOME, 16CM, 14MM, STRAIGHT
27-O-28	CINELLI GUARDED OSTEOTOME, 16CM, 16MM, STRAIGHT

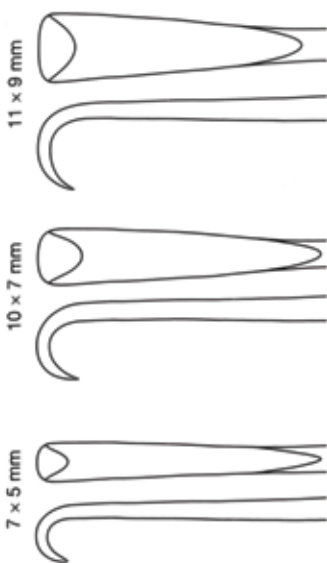

Item Code	Description
28-R-26	OBWEGESER PERIOSTEAL ELEVATOR / RASPATORY, 20CM, 7X5MM, CURVED, SHARP
28-R-27	OBWEGESER PERIOSTEAL ELEVATOR / RASPATORY, 20CM, 10X7MM, CURVED, SHARP
28-R-28	OBWEGESER PERIOSTEAL ELEVATOR / RASPATORY, 20CM, 11X9MM, CURVED, SHARP



Osteotomes and Raspatories

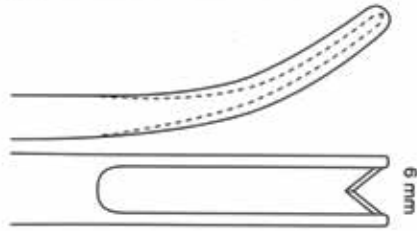

Item Code	Description
27-O-29	BLUME GUARDED OSTEOTOME, 18CM, 6MM, CURVED, V SHAPED TIP

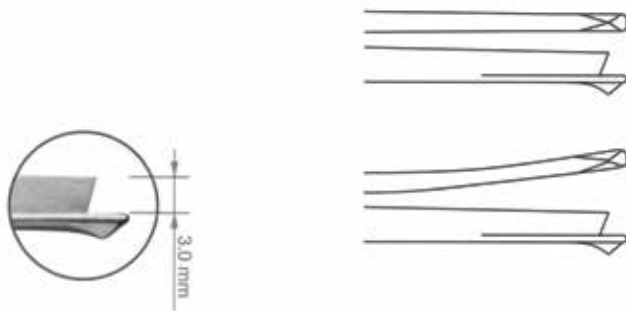

Item Code	Description
27-O-30	SCHROM OSTEOTOME, 19.5CM, 3MM, STRAIGHT, WITH GUIDE THORN
27-O-31	SCHROM OSTEOTOME, 19.5CM, 3MM, RIGHT, WITH GUIDE THORN
27-O-32	SCHROM OSTEOTOME, 19.5CM, 3MM, LEFT, WITH GUIDE THORN

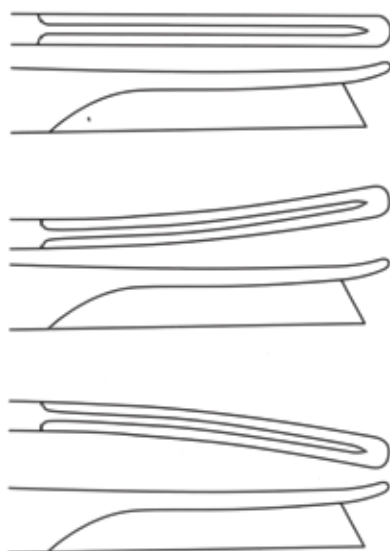

Item Code	Description
27-O-33	SILVER OSTEOTOME, 18CM, STRAIGHT
27-O-34	SILVER OSTEOTOME, 18CM, CURVED LEFT
27-O-35	SILVER OSTEOTOME, 18CM, CURVED RIGHT



Osteotomes and Raspatories

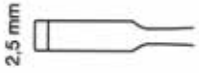

Item Code	Description
27-O-36	OBWEGESER OSTEOTOME, 15CM, 2.5MM
27-O-37	OBWEGESER OSTEOTOME, 15CM, 4.0MM



Item Code	Description
27-O-38	OBWEGESER SPLITTING OSTEOTOME, 21.5CM, 7MM
27-O-39	OBWEGESER SPLITTING OSTEOTOME, 21.5CM, 10MM



Item Code	Description
27-O-40	OBWEGESER WEDGE OSTEOTOME, 22CM, 8MM
27-O-41	OBWEGESER WEDGE OSTEOTOME, 22CM, 12MM
27-O-42	OBWEGESER WEDGE OSTEOTOME, 22CM, 16MM

Osteotomes and Raspatories

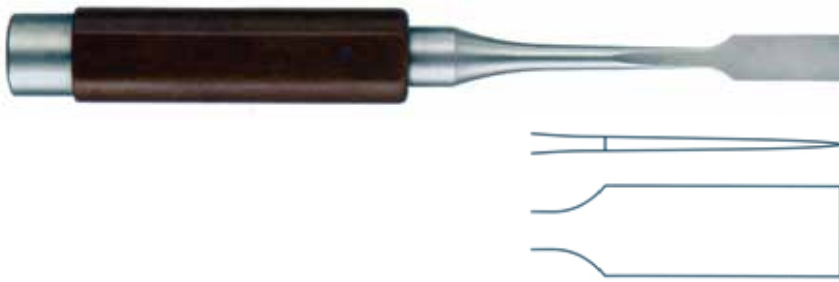

Item Code	Description
27-O-43	OBWEGESER BLADE OSTEOTOME, 22CM, 8MM
27-O-44	OBWEGESER BLADE OSTEOTOME, 22CM, 12MM
27-O-45	OBWEGESER BLADE OSTEOTOME, 22CM, 16MM
27-O-46	OBWEGESER BLADE OSTEOTOME, 22CM, 20MM

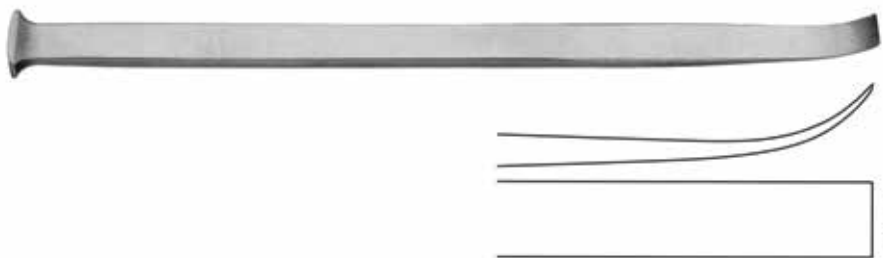

Item Code	Description
27-O-47	OBWEGESER PTERYGOID OSTEOTOME, 23.5CM, 10MM, CURVED

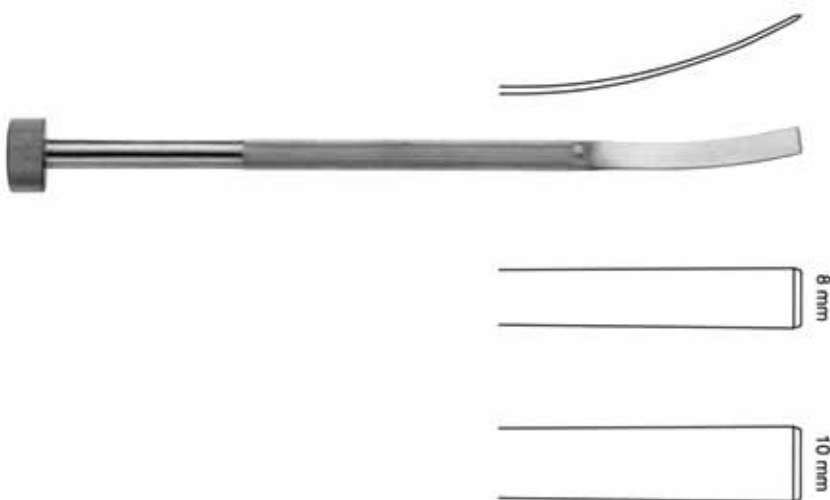

Item Code	Description
27-O-48	OBWEGESER FLEXIBLE OSTEOTOME, 21CM, 8MM, CURVED
27-O-49	OBWEGESER FLEXIBLE OSTEOTOME, 21CM, 10MM, CURVED



Osteotomes and Raspatories

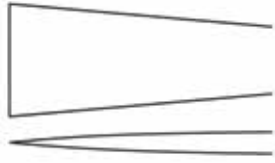

Item Code Description

27-O-51	TESSIER OSTEOTOME, 20.5CM, 10MM, STRAIGHT
27-O-52	TESSIER OSTEOTOME, 20.5CM, 10MM, CURVED
27-O-53	TESSIER OSTEOTOME, 20.5CM, 15MM, STRAIGHT
27-O-54	TESSIER OSTEOTOME, 20.5CM, 15MM, CURVED
27-O-55	TESSIER OSTEOTOME, 20.5CM, 20MM, STRAIGHT
27-O-56	TESSIER OSTEOTOME, 20.5CM, 30MM, STRAIGHT

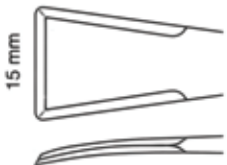

Item Code Description

27-O-57	TESSIER OSTEOTOME, 16CM, 10MM, STRAIGHT, BEVELED EDGES
27-O-58	TESSIER OSTEOTOME, 16CM, 10MM, CURVED, BEVELED EDGES
27-O-59	TESSIER OSTEOTOME, 16CM, 15MM, STRAIGHT, BEVELED EDGES
27-O-60	TESSIER OSTEOTOME, 16CM, 15MM, CURVED, BEVELED EDGES

Osteotomes and Raspatories

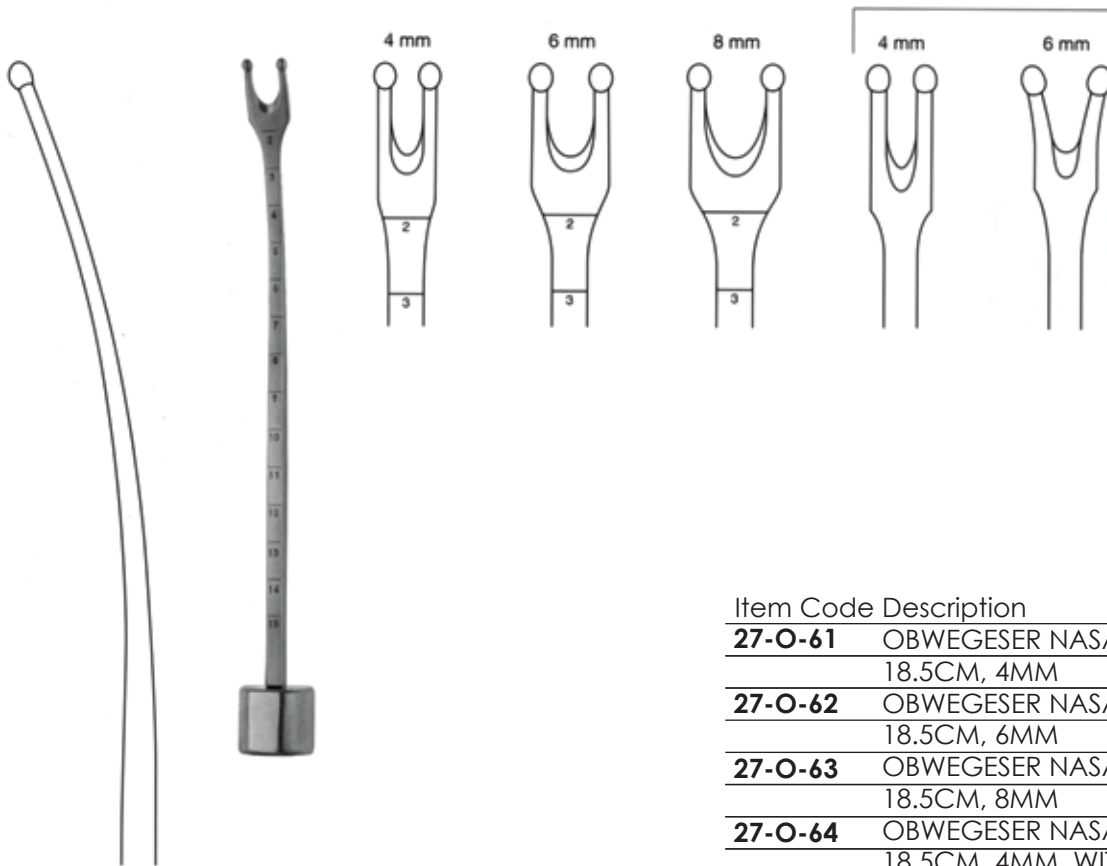

Item Code	Description
27-O-61	OBWEGESER NASAL SEPTUM OSTEOTOME, 18.5CM, 4MM
27-O-62	OBWEGESER NASAL SEPTUM OSTEOTOME, 18.5CM, 6MM
27-O-63	OBWEGESER NASAL SEPTUM OSTEOTOME, 18.5CM, 8MM
27-O-64	OBWEGESER NASAL SEPTUM OSTEOTOME, 18.5CM, 4MM, WITHOUT SCALE

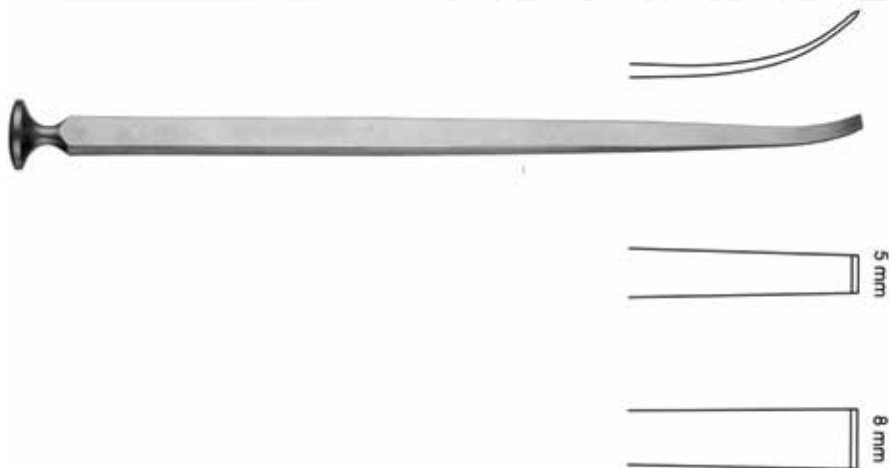

Item Code	Description
27-O-66	STEINHAUSER ORBITAL OSTEOTOME, 22.5CM, 5MM, CURVED
27-O-67	STEINHAUSER ORBITAL OSTEOTOME, 22.5CM, 8MM, CURVED



Osteotomes and Raspatories



Item Code	Description
27-O-79	ROZNER NASAL OSTEOTOME, 6.5 MM WIDTH, 6 1/2" (165 MM) LENGTH



Item Code	Description
27-O-80	GIUNTA OSTEOTOME, DOUBLE GUARDED, CURVED, 4 MM WIDTH, 7" (178 MM) LENGTH



Item Code	Description
27-O-81	LAMBOTTE OSTEOTOME, 4 MM WIDTH, 5" (127 MM) LENGTH
27-O-82	LAMBOTTE OSTEOTOME, 6 MM WIDTH, 5" (127 MM) LENGTH
27-O-83	LAMBOTTE OSTEOTOME, 8 MM WIDTH, 5" (127 MM) LENGTH
27-O-84	LAMBOTTE OSTEOTOME, 10 MM WIDTH, 5" (127 MM) LENGTH
27-O-85	LAMBOTTE OSTEOTOME, 12 MM WIDTH, 5" (127 MM) LENGTH



Item Code	Description
28-R-01	FREER RASPATORY, 19CM, 5/5MM, DOUBLE ENDED, SHARP / SHARP

Osteotomes and Raspatories

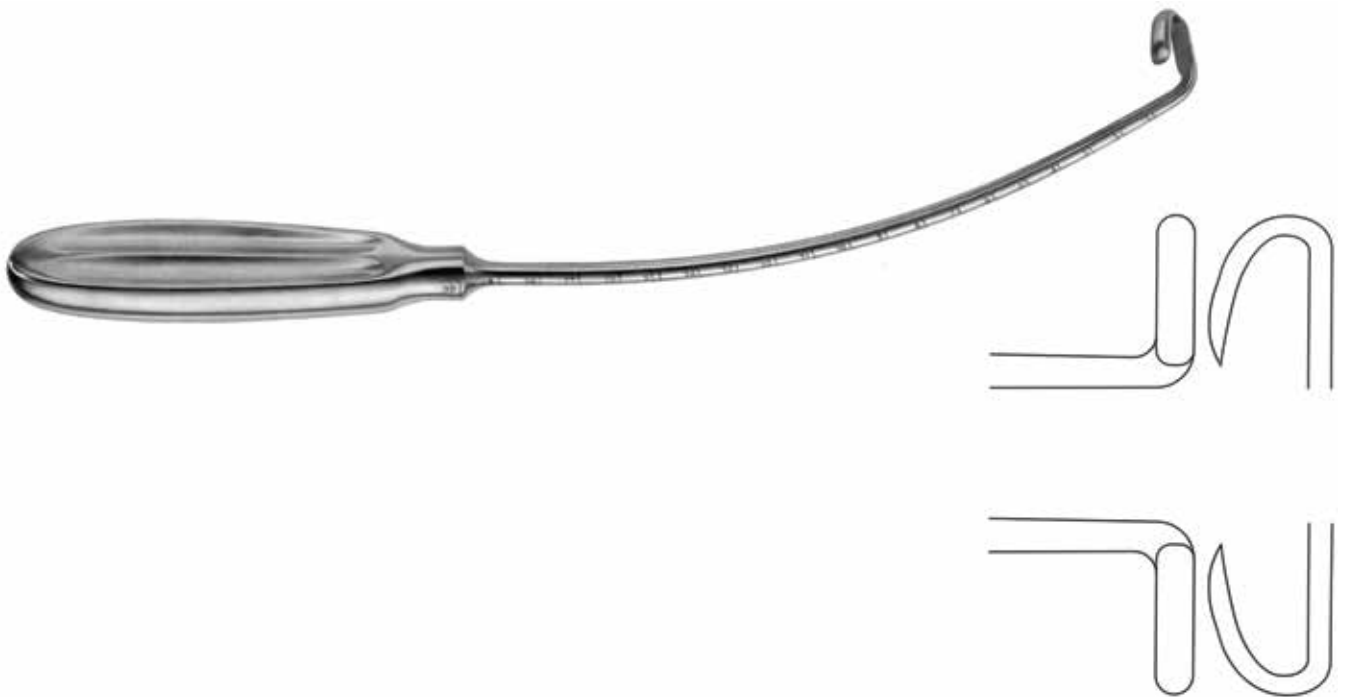

Item Code Description

28-R-09	OBWEGESER RIB RASPATORY, 30CM, LEFT
28-R-10	OBWEGESER RIB RASPATORY, 30CM, RIGHT

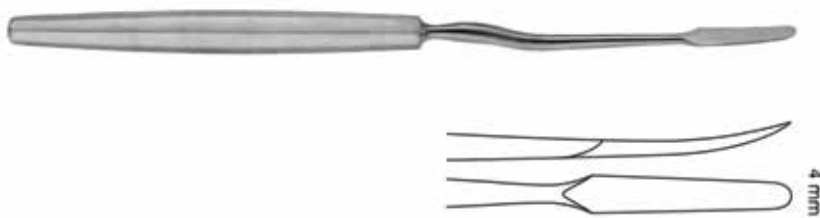

Item Code Description

28-R-11	JOSEPH MASING SEPTUM RASPATORY, 22CM, 4MM, SHARP
----------------	---



Item Code Description

28-R-12	COTTLE PERIOSTEAL ELEVATOR/RASPATORY, 18CM, 8MM, SHARP
----------------	---



Osteotomes and Raspatories

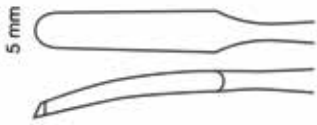

Item Code	Description
28-R-13	CONVERSE PERIOSTEAL ELEVATOR/ RASPATORY, 18CM, 5MM, SHARP

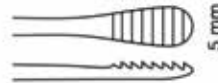
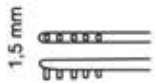

Item Code	Description
28-R-14	COTTLE PERIOSTEUM COMB AND RASPATORY, 23CM, 1.5/5MM, DOUBLE ENDED



Item Code	Description
28-R-15	COTTLE MCKENTY RASPATORY, 22CM, 4/4MM, DOUBLE ENDED, SHARP

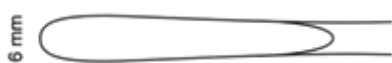

Item Code	Description
28-R-16	OBWEGESER PERIOSTEAL ELEVATOR / RASPATORY, 17.5CM, 6MM, SHARP
28-R-17	OBWEGESER PERIOSTEAL ELEVATOR / RASPATORY, 17.5CM, 7MM, SHARP
28-R-18	OBWEGESER PERIOSTEAL ELEVATOR / RASPATORY, 17.5CM, 9MM, SHARP
28-R-19	OBWEGESER PERIOSTEAL ELEVATOR / RASPATORY, 17.5CM, 11MM, SHARP

Osteotomes and Raspatories

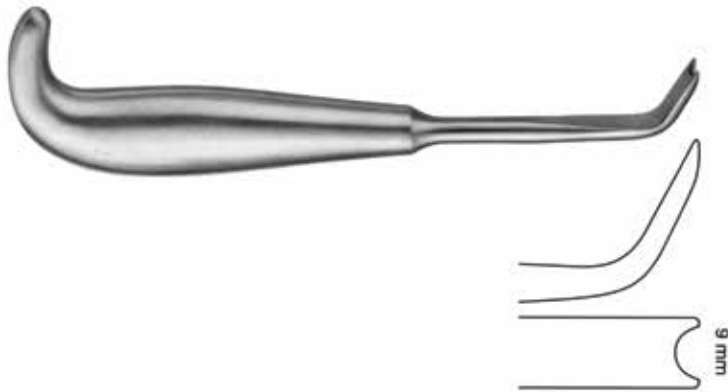

Item Code	Description
28-R-20	HARGIS RASPATORY, 19CM, 9MM, ANGLED

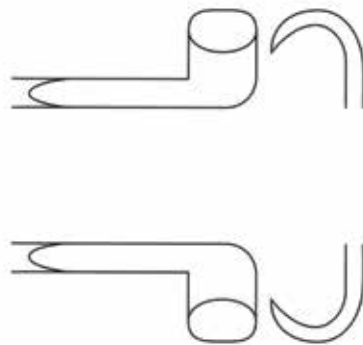

Item Code	Description
28-R-21	OBWEGESER MANDIBULAR RIM STRIPPER, 19CM



Item Code	Description
28-R-23	OBWEGESER PERIOSTEAL ELEVATOR / RASPATORY, 17.5CM, 9MM, V NOTCH



Osteotomes and Raspatories

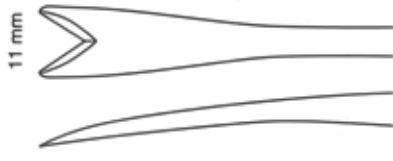

Item Code	Description
28-R-24	OBWEGESER SWALLOWTAIL STRIPPER, 17.5CM, 7MM
28-R-25	OBWEGESER SWALLOWTAIL STRIPPER, 17.5CM, 11MM

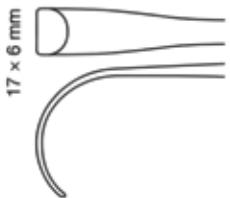

Item Code	Description
28-R-29	OBWEGESER FREER PERIOSTEAL ELEVATOR, 21CM, SHARP / BLUNT
28-R-30	OBWEGESER FREER PERIOSTEAL ELEVATOR / RASPATORY, 21CM, 5MM SHARP / 10X5MM BLUNT
28-R-31	OBWEGESER FREER PERIOSTEAL ELEVATOR / RASPATORY, 21CM, 6MM SHARP / 13X6MM BLUNT



Item Code	Description
28-R-32	OBWEGESER PERIOSTEAL ELEVATOR, 18CM, 6MM, BEVELED EDGE
28-R-33	OBWEGESER PERIOSTEAL ELEVATOR, 18CM, 7MM, BEVELED EDGE
28-R-34	OBWEGESER PERIOSTEAL ELEVATOR, 18CM, 9MM, BEVELED EDGE
28-R-35	OBWEGESER PERIOSTEAL ELEVATOR, 18CM, 11MM, BEVELED EDGE

Osteotomes and Raspatories



Item Code	Description
28-R-36	DINGMAN PERIOSTEAL ELEVATOR / RASPATORY, 18CM, 4/7MM, SHARP / BLUNT



Item Code	Description
28-R-37	TESSIER RASPATORY, 18CM, 8X6MM, 30 DEGREE CURVED
28-R-38	TESSIER RASPATORY, 18CM, 12X6MM, 60 DEGREE CURVED



Item Code	Description
28-R-39	STEINHAUSER ORBITAL FLOOR RASPATORY, 17CM, 9X4MM



Suction Raspatories

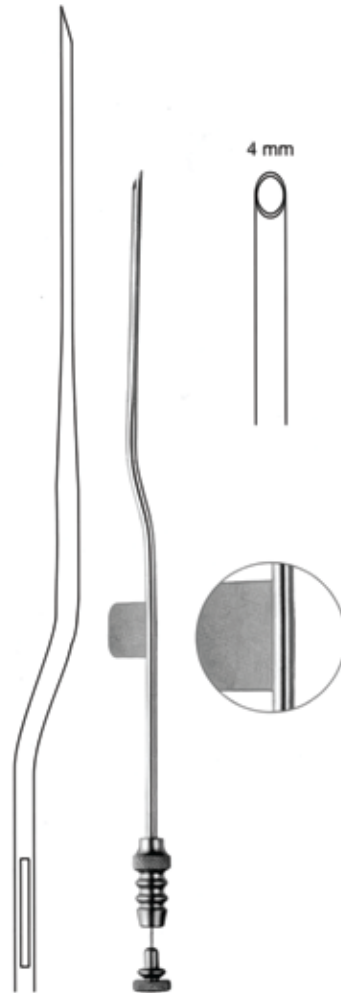

Item Code	Description
32-SR-01	SUCTION RASPATORY WITH GUIDE, 20CM, 4MM

Wires And Wire Instruments



Item Code	Description
34-WWI-01	OBWEGESER T.C. WIRE TWISTER, 13CM



MAIZ
RNATIONAL

Item Code	Description
34-WWI-02	OBWEGESER WIRE LOOP CLIP, 15.5CM



Suggested Instruments

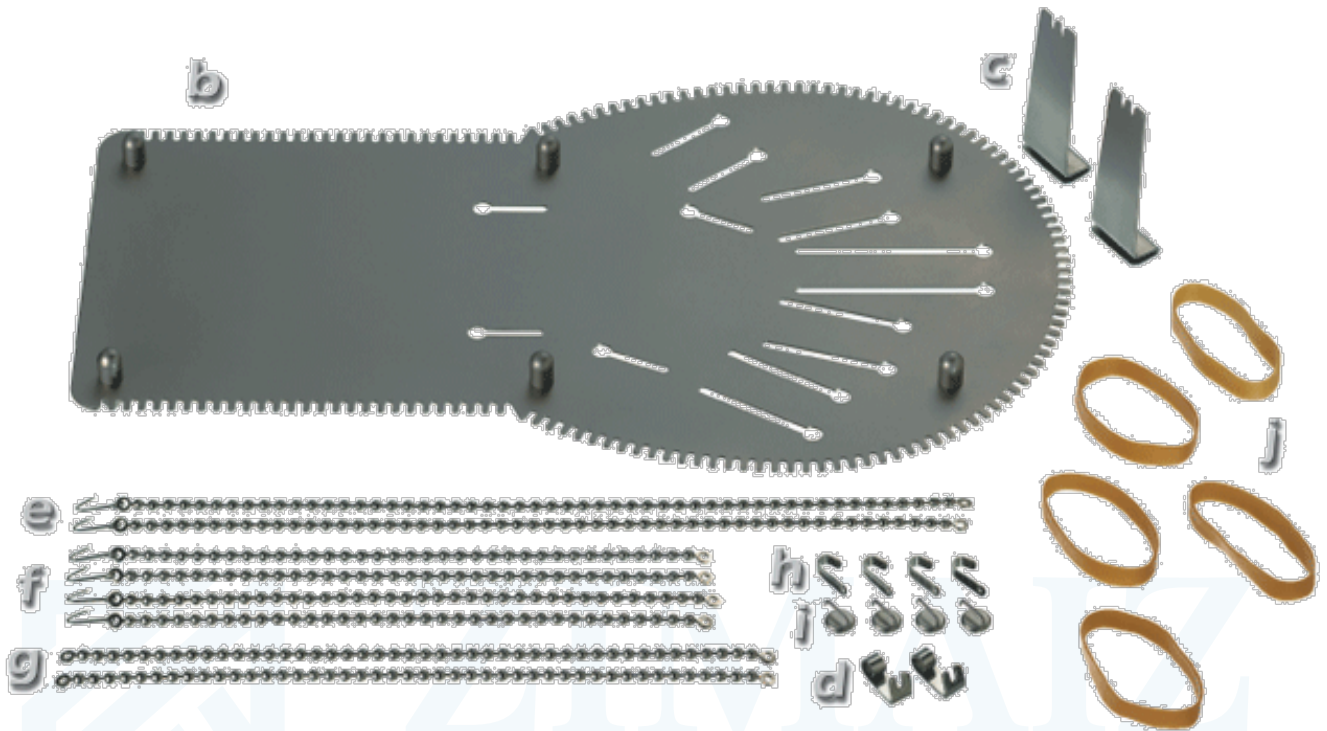

ZIMAIZ
INTERNATIONAL

Item Code	Description
SU-I-01-01	Tuppers Hand Retractor Set, Medium
SU-I-01-02	Tuppers Hand Retractor Set, For Infants
SU-I-01-03	Tuppers Hand Retractor Set, For Adults



Delicate Dressing & Tissue Forceps



Item Code	Description
DDT-01-01	TISSUE FORCEPS, 14.5CM, 1X2 TEETH



Item Code	Description
DDT-01-02	HUDSON EWALD DRESSING FORCEPS, 12CM, SERRATED



Item Code	Description
DDT-01-03	HUDSON EWALD TISSUE FORCEPS, 12CM, 1X2 TEETH



Item Code	Description
DDT-01-04	ADSON FORCEPS, 12CM, SERRATED
DDT-01-07	ADSON FORCEPS, 12CM, 1X2 TEETH



Item Code	Description
DDT-01-05	ADSON T.C.(TUNGSTEN CARBIDE) TISSUE FORCEPS, 12CM



Item Code	Description
DDT-01-06	ADSON T.C.(TUNGSTEN CARBIDE) TISSUE FORCEPS, 15CM



Item Code	Description
DDT-01-08	ADSON TISSUE FORCEPS, 12CM, CROSS SERRATED



Item Code	Description
DDT-01-09	ADSON DELICATE TISSUE AND SUTURE FORCEPS, 15CM, 1X2 TEETH





Delicate Dressing & Tissue Forceps



Item Code	Description
DDT-01-10	ADSON T.C. (TUNGSTEN CARBIDE) DELICATE TISSUE AND SUTURE FORCEPS, 12CM, 1X2 TEETH



Item Code	Description
DDT-01-11	ADSON T.C. (TUNGSTEN CARBIDE) TISSUE AND SUTURE FORCEPS, 15CM, 1X2 TEETH



Item Code	Description
DDT-01-12	MICRO ADSON FORCEPS, 12CM, SERRATED
DDT-01-14	MICRO ADSON FORCEPS, 12CM, 1X2 TEETH
DDT-01-13	MICRO ADSON FORCEPS, 15CM, SERRATED
DDT-01-15	MICRO ADSON FORCEPS, 15CM, 1X2 TEETH



Item Code	Description
DDT-01-16	ADSON BROWN DELICATE TISSUE FORCEPS, 12CM, 7X7 TEETH, STRAIGHT



DDT-01-17	ADSON BROWN DELICATE TISSUE FORCEPS, 12CM, 9X9 TEETH, STRAIGHT
------------------	---



Item Code	Description
DDT-01-18	ADSON BROWN DELICATE TISSUE FORCEPS, 12CM, 7X7 TEETH, ANGLED



Item Code	Description
DDT-01-19	ADSON GRAEFE DELICATE TISSUE FORCEPS, 12CM

Delicate Dressing & Tissue Forceps



Item Code Description

DDT-01-20 SEMKEN DELICATE DRESSING AND TISSUE FORCEPS, 12.5CM, STRAIGHT

DDT-01-22 SEMKEN DELICATE DRESSING FORCEPS, 12.5CM, CURVED

DDT-01-21 SEMKEN DELICATE DRESSING FORCEPS, 15CM, STRAIGHT

DDT-01-23 SEMKEN DELICATE DRESSING FORCEPS, 15CM, CURVED



Item Code Description

DDT-01-24 SEMKEN DELICATE TISSUE FORCEPS, 12.5CM, 1X2 TEETH, STRAIGHT

DDT-01-26 SEMKEN DELICATE TISSUE FORCEPS, 12.5CM, 1X2 TEETH, CURVED

DDT-01-25 SEMKEN DELICATE TISSUE FORCEPS, 15CM, 1X2 TEETH, STRAIGHT

DDT-01-27 SEMKEN DELICATE TISSUE FORCEPS, 15CM, 1X2 TEETH, CURVED



Item Code Description

DDT-01-28 SEMKEN DELICATE TISSUE FORCEPS, 12.5CM, 2X3 TEETH, STRAIGHT



Delicate Dressing & Tissue Forceps



Item Code Description

DDT-01-29 MCINDOE DRESSING FORCEPS, 15CM, SERRATED



Item Code Description

DDT-01-30 GILLIES TISSUE FORCEPS, 15CM, 1X2 TEETH



Item Code Description

DT-02-01 WAUGH DRESSING FORCEPS, 15CM, SERRATED

DT-02-03 WAUGH TISSUE FORCEPS, 15CM, 1X2 TEETH



Item Code Description

DT-02-02 WAUGH DRESSING FORCEPS, 20CM, SERRATED

DT-02-04 WAUGH TISSUE FORCEPS, 20CM, 1X2 TEETH



Item Code Description

DT-02-06 GRUENWALD JANSEN NASAL BAYONET FORCEPS, 16CM, SERRATED



Hemostatic Forceps



Item Code	Description
HF-03-01	DIETRICH BULLDOG CLAMP, 4.5CM, STRAIGHT JAW, 8MM
HF-03-02	DIETRICH BULLDOG CLAMP, 5CM, STRAIGHT JAW, 12MM
HF-03-03	DIETRICH BULLDOG CLAMP, 5.5CM, STRAIGHT JAW, 16MM



ZIMAIZ
INTERNATIONAL

Item Code	Description
HF-03-04	DIETRICH BULLDOG CLAMP, 4.5CM, CURVED JAW, 8MM
HF-03-05	DIETRICH BULLDOG CLAMP, 5CM, CURVED JAW, 12MM
HF-03-06	DIETRICH BULLDOG CLAMP, 5.5CM, CURVED JAW, 16MM



Item Code	Description
HF-03-19	ATRAUMATIC MOSQUITO FORCEPS, 12CM, STRAIGHT
HF-03-24	ATRAUMATIC MOSQUITO FORCEPS, 12CM, CURVED



Hemostatic Forceps



Item Code Description

HF-03-07 HALSTED MICRO MOSQUITO FORCEPS, 12.5CM, STRAIGHT



HF-03-08 HALSTED MICRO MOSQUITO FORCEPS, 12.5CM, CURVED



Item Code Description

HF-03-13 HALSTED MICRO MOSQUITO FORCEPS, 12.5CM, 1X2 TEETH, STRAIGHT

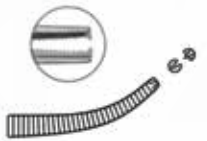

HF-03-14 HALSTED MICRO MOSQUITO FORCEPS, 12.5CM, 1X2 TEETH, CURVED

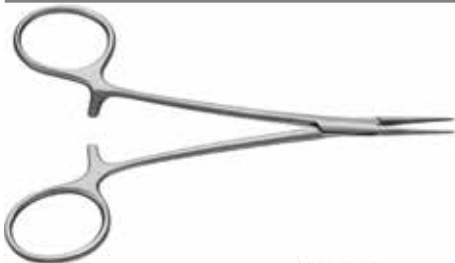

Item Code Description

HF-03-09 JACOBSON MICRO MOSQUITO FORCEPS, 12.5CM, STRAIGHT



HF-03-10 JACOBSON MICRO MOSQUITO FORCEPS, 12.5CM, CURVED

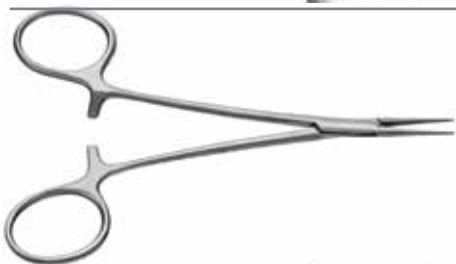

Item Code Description

HF-03-11 JACOBSON KOSHIMA MICRO MOSQUITO FORCEPS, 12.5CM, STRAIGHT



HF-03-12 JACOBSON KOSHIMA MICRO MOSQUITO FORCEPS, 12.5CM, CURVED

Hemostatic Forceps



Item Code	Description
HF-03-15	ULTRA DELICATE ARTERY FORCEPS, 10CM, STRAIGHT
HF-03-20	ULTRA DELICATE ARTERY FORCEPS, 10CM, CURVED
HF-03-17	ULTRA DELICATE ARTERY FORCEPS, 2.5CM, STRAIGHT
HF-03-22	ULTRA DELICATE ARTERY FORCEPS, 12.5CM, CURVED



Item Code	Description
HF-03-29	PROVIDENCE HOSPITAL ARTERY FORCEPS, 14CM, STRAIGHT
HF-03-30	PROVIDENCE HOSPITAL ARTERY FORCEPS, 14CM, CURVED
HF-03-31	PROVIDENCE HOSPITAL ARTERY FORCEPS, 14CM, 1X2 TEETH, STRAIGHT
HF-03-32	PROVIDENCE HOSPITAL ARTERY FORCEPS, 14CM, 1X2 TEETH, CURVED



Hemostatic Forceps

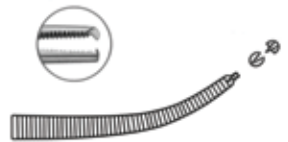

Item Code Description

HF-03-33 LERICHE ARTERY FORCEPS, 15CM,
STRAIGHT

HF-03-34 LERICHE ARTERY FORCEPS, 15CM,
CURVED

HF-03-35 LERICHE ARTERY FORCEPS, 15CM,
1X2 TEETH, STRAIGHT

HF-03-36 LERICHE ARTERY FORCEPS, 15CM,
1X2 TEETH, CURVED

INTERNATIONAL

Micro Forceps



Item Code	Description
MF-04-01-01	Jewelers Forceps, Tapered Fine Points, 11.5cm, No. 3
MF-04-01-02	Jewelers Forceps, Tapered Fine Points, 11.5cm, No. 4
MF-04-01-03	Jewelers Forceps, Tapered Fine Points, 11.5cm, No. 5
MF-04-01-04	Jewelers Forceps, Tapered Fine Points, 11.5cm, No. 7



Item Code	Description
MF-04-02	Ultra Fine Micro Forceps, 11 cm, 0.1mm Tips



Item Code	Description
MF-04-03-01	Micro Forceps, 11.5cm, 1x2 Teeth, Straight
MF-04-03-02	Micro Forceps, 11.5cm, 1x2 Teeth, Curved



Item Code	Description
MF-04-04-01	Micro Forceps, Straight, Sharp, 10.5cm, 0.2mm Tip
MF-04-04-02	Micro Forceps, Straight, Sharp, 10.5cm, 0.3mm Tip



Micro Forceps



Item Code	Description
MF-04-05-01	Micro Forceps, Curved, 11.5cm, Sharp, 0.2mm Tip
MF-04-05-02	Micro Forceps, Curved, 11.5cm, Sharp, 0.3mm Tip



Item Code	Description
MF-04-06-01	Micro Forceps, 45 Degree Angle, Sharp, 10.5cm, 0.2mm Tip
MF-04-06-02	Micro Forceps, 45 Degree Angle, Sharp, 10.5cm, 0.3mm Tip



Item Code	Description
MF-04-07-01	Ultra Fine Micro Forceps, Sharp, 14cm, 0.1mm Tip
MF-04-07-02	Ultra Fine Micro Forceps, Sharp, 14cm, 0.2mm Tip
MF-04-07-03	Ultra Fine Micro Forceps, Sharp, 14cm, 0.3mm Tip



Item Code	Description
MF-04-08-01	Micro Forceps, Round Handle, 12cm, Sharp, Straight
MF-04-08-02	Micro Forceps, Round Handle, 12cm, Sharp, Curved



Item Code	Description
MF-04-09-01	Ultra Fine Adson Forceps, 12cm, 0.1mm Tip
MF-04-09-02	Ultra Fine Adson Forceps, 12cm, 0.2mm Tip

Micro Forceps



Item Code	Description
MF-04-10	Micro Adson Forceps, 15 cm, 0.3 mm, Sharp



ZIMAIZ
INTERNATIONAL



Tissue Grasping Forceps



Item Code	Description
TGF-06-01	DEBAKEY ATRAUMATIC VASCULAR FORCEPS, 15CM

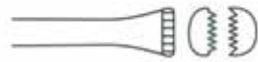

Item Code	Description
TGF-06-02	NELSON TISSUE FORCEPS, 15CM
TGF-06-03	NELSON TISSUE FORCEPS, 23CM



Item Code	Description
TGF-06-04	BAYONET GRASPING FORCEPS, 16CM



Item Code	Description
TGF-06-06	TROELTSCH WILDE ANGULAR FORCEPS, 13CM, ADULT

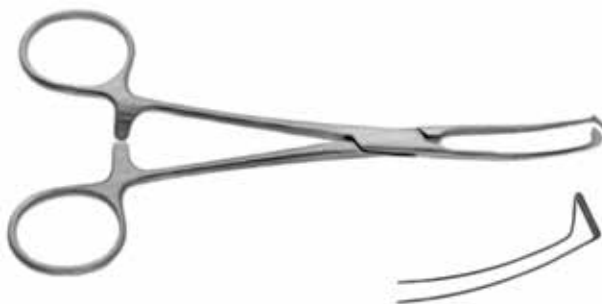

Item Code	Description
TGF-06-12	FOX TISSUE GRASPING FORCEPS, 15.5CM

Tissue Grasping Forceps



Item Code Description
TGF-06-13 COTTLE NASAL FORCEPS, 15CM

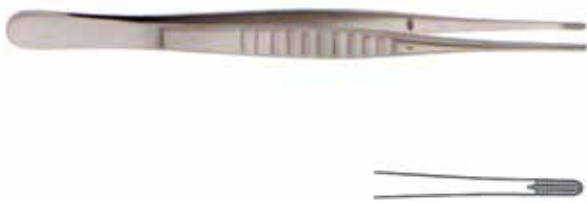

Item Code Description
TGF-06-08 COTTLE FIXATION FORCEPS, 15CM

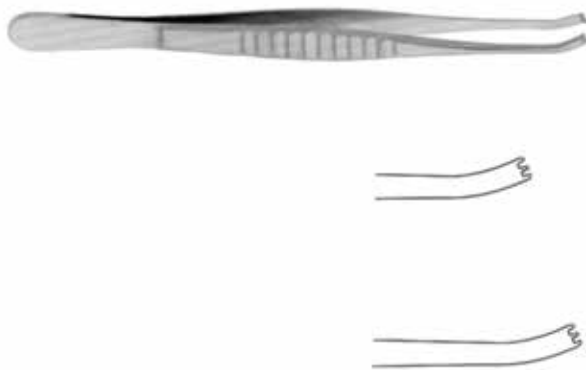

Item Code Description
TGF-06-09 FOX TISSUE FORCEPS, 13CM, CURVED
TGF-06-10 FOX TISSUE FORCEPS, 15CM, CURVED



Item Code Description
TGF-06-11 FOX TISSUE FORCEPS, 15CM, WITH CATCH

ZIMAIZ
 INTERNATIONAL



Needle Holders



Item Code	Description
ND-07-01	COLLIER NEEDLE HOLDER, 13CM

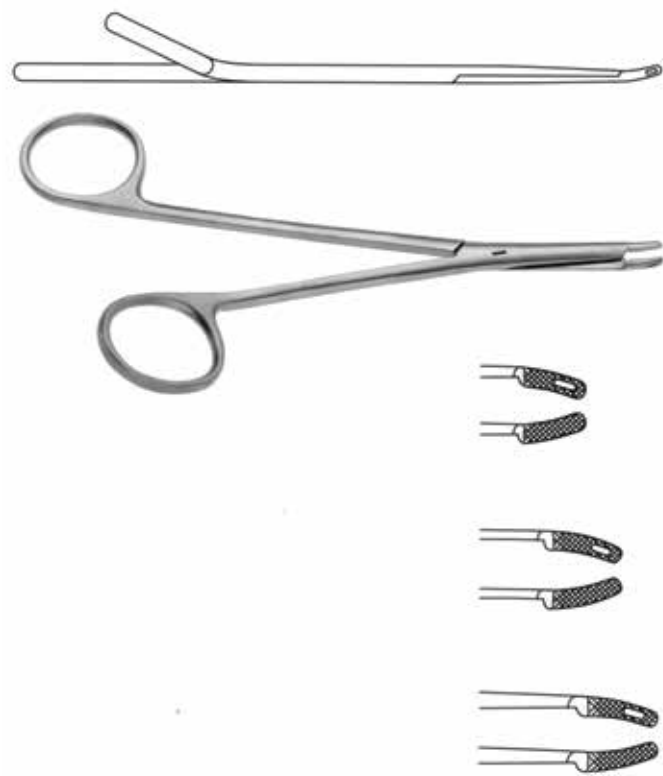

MAIZ
INTERNATIONAL

Item Code	Description
ND-07-02	OBWEGESER GILLIES NEEDLE HOLDER WITH SCISSORS, 11.5CM
ND-07-04	OBWEGESER GILLIES NEEDLE HOLDER WITH SCISSORS, 14.5CM
ND-07-06	OBWEGESER GILLIES NEEDLE HOLDER WITH SCISSORS, 17CM

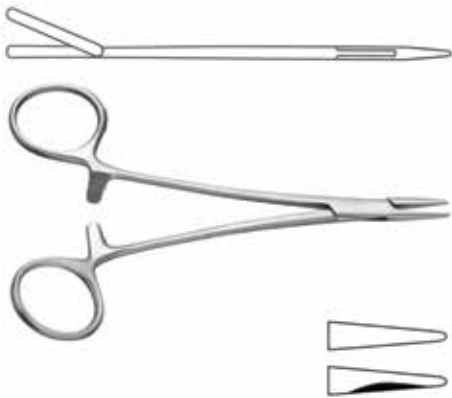

Item Code	Description
ND-07-03	NEIVERT NEEDLE HOLDER, 12.5CM

Needle Holders

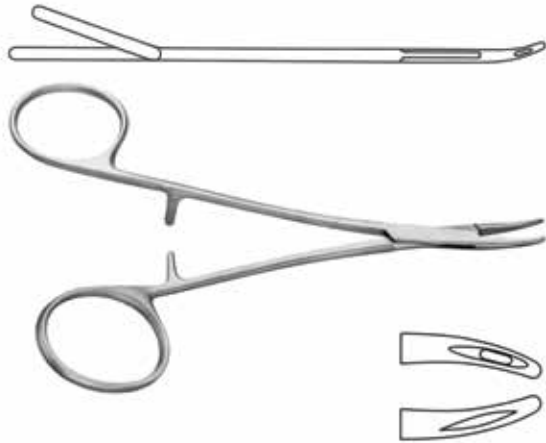

Item Code	Description
ND-07-05	CONVERSE NEEDLE HOLDER, 15CM

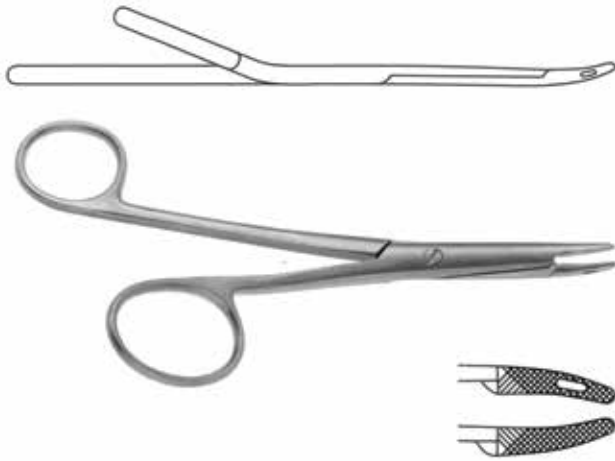

Item Code	Description
ND-07-07	OBWEGESER GILLIES NEEDLE HOLDER WITH SCISSORS, 16CM, HEAVY MODEL



Item Code	Description
ND-07-08	NEIVERT T.C. NEEDLE HOLDER, 12.5CM, SMOOTH

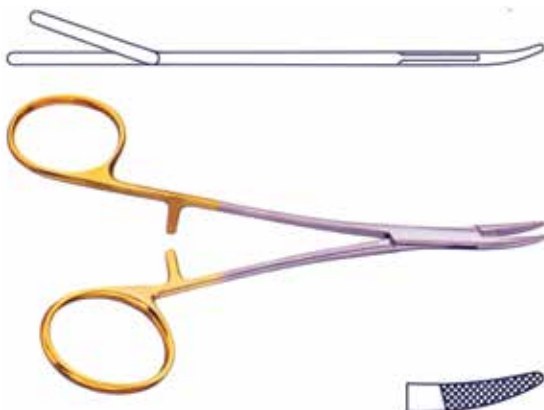

Item Code	Description
ND-07-09	CONVERSE T.C. NEEDLE HOLDER, 15CM



Needle Holders



Item Code Description

ND-07-10 NAGATA T.C. NEEDLE HOLDER, 11.5CM

ND-07-11 NAGATA T.C. NEEDLE HOLDER, 13CM



Item Code Description

ND-07-12 WRIGHT DERF NEEDLE HOLDER, 12.5CM



Item Code Description

ND-07-13 HALSEY NEEDLE HOLDER, 13.5CM,
SERRATED



Item Code Description

ND-07-14 GUBISCH T.C. NEEDLE HOLDER, 12.5CM,
EXTRA FINE



Needle Holders



Item Code	Description
ND-07-15	WRIGHT DERF T.C. NEEDLE HOLDER, 12.5CM, SERRATED



Item Code	Description
ND-07-17	DERF CONVERSE NEEDLE HOLDER, 12.5CM

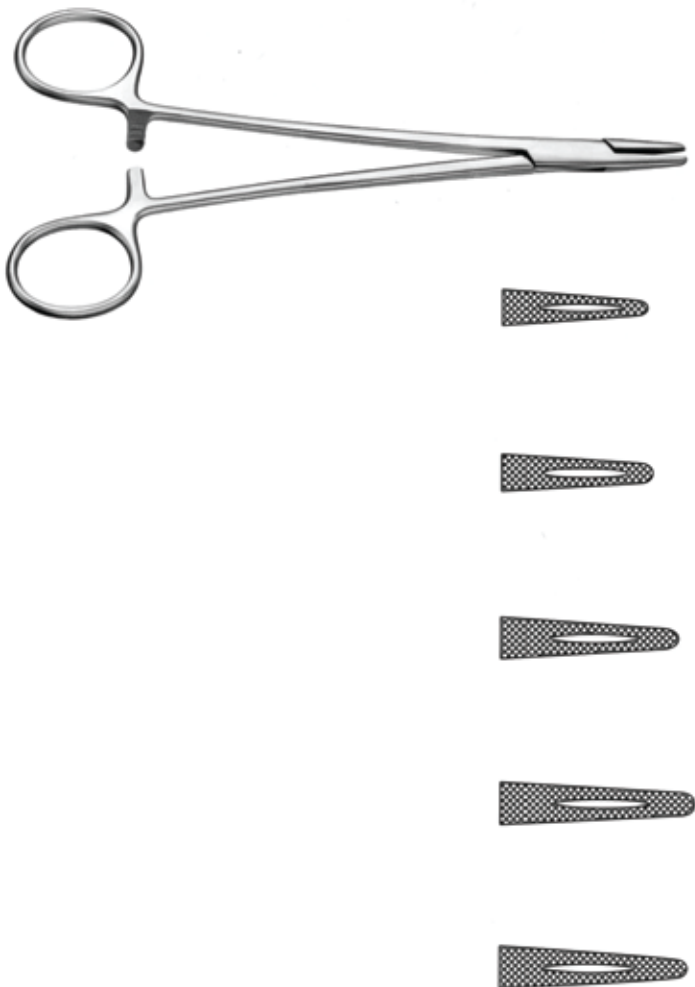

Item Code	Description
ND-07-18	MAYO HEGAR NEEDLE HOLDER, 15CM
ND-07-19	MAYO HEGAR NEEDLE HOLDER, 18CM
ND-07-20	MAYO HEGAR NEEDLE HOLDER, 20CM
ND-07-21	MAYO HEGAR NEEDLE HOLDER, 23CM
ND-07-22	MAYO HEGAR NEEDLE HOLDER, 24CM



Needle Holders

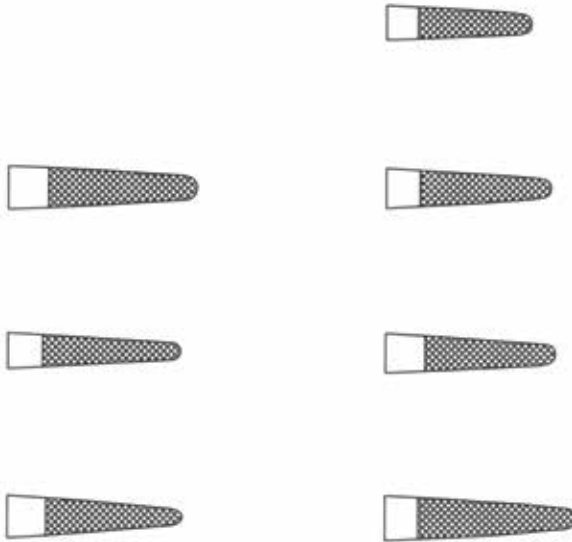
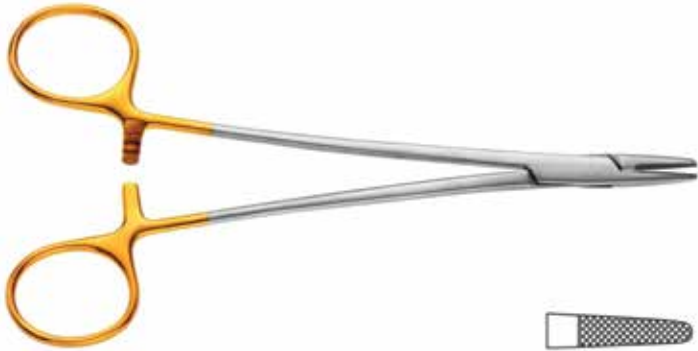

Item Code Description

ND-07-23	MAYO HEGAR T.C. NEEDLE HOLDER, 15CM
ND-07-24	MAYO HEGAR T.C. NEEDLE HOLDER, 18CM
ND-07-25	MAYO HEGAR T.C. NEEDLE HOLDER, 20CM
ND-07-26	MAYO HEGAR T.C. NEEDLE HOLDER, 23CM
ND-07-27	MAYO HEGAR T.C. NEEDLE HOLDER, 24CM
ND-07-28	MAYO HEGAR T.C. NEEDLE HOLDER, 26CM
ND-07-29	MAYO HEGAR T.C. NEEDLE HOLDER, 30CM

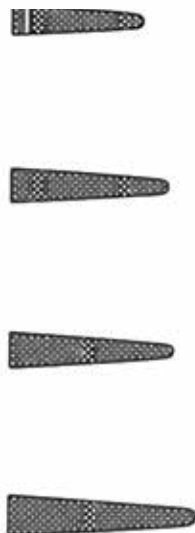

Item Code Description

ND-07-34	CRILE WOOD NEEDLE HOLDER, 15CM
ND-07-35	CRILE WOOD NEEDLE HOLDER, 18CM
ND-07-36	CRILE WOOD NEEDLE HOLDER, 20CM
ND-07-37	CRILE WOOD NEEDLE HOLDER, 23CM



Micro Forceps

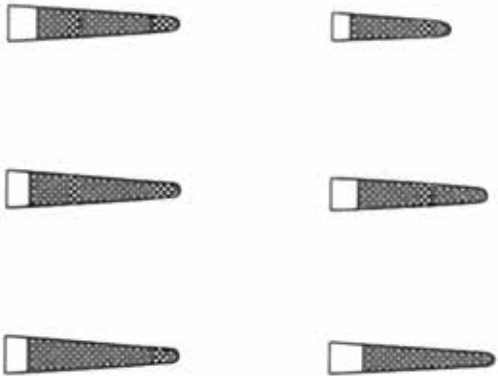

Item Code	Description
ND-07-38	CRILE WOOD T.C. NEEDLE HOLDER, 15CM
ND-07-39	CRILE WOOD T.C. NEEDLE HOLDER, 18CM
ND-07-40	CRILE WOOD T.C. NEEDLE HOLDER, 20CM
ND-07-41	CRILE WOOD T.C. NEEDLE HOLDER, 23CM
ND-07-42	CRILE WOOD T.C. NEEDLE HOLDER, 25CM
ND-07-43	CRILE WOOD T.C. NEEDLE HOLDER, 30CM

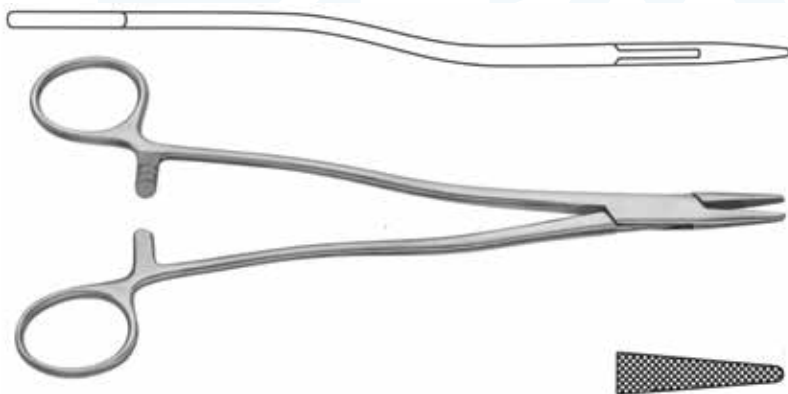

ZIMAIZ
NATIONAL

Item Code	Description
ND-07-44	THOMSON WALKER BOZEMANN NEEDLE HOLDER, 21CM, S SHAPE

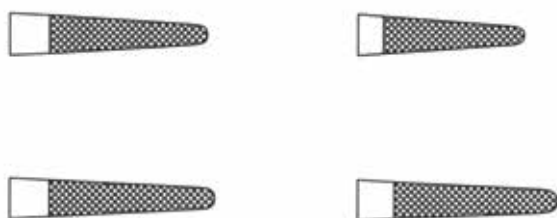
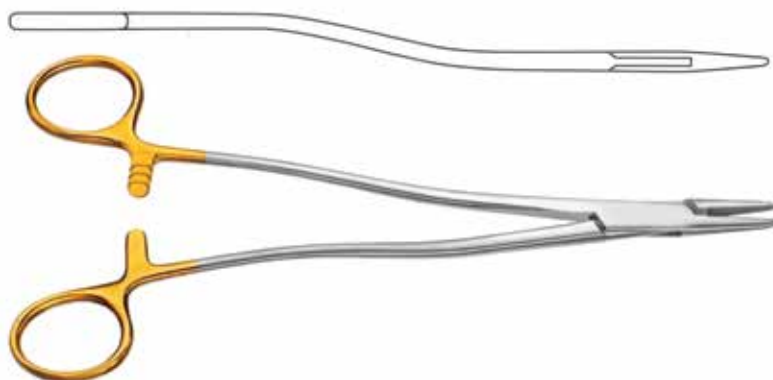

Item Code	Description
ND-07-45	BOZEMANN WERTHEIM T.C. NEEDLE HOLDER, 21CM, S SHAPE
ND-07-46	BOZEMANN WERTHEIM T.C. NEEDLE HOLDER, 24CM, S SHAPE
ND-07-47	BOZEMANN WERTHEIM T.C. NEEDLE HOLDER, 26CM, S SHAPE
ND-07-48	BOZEMANN WERTHEIM T.C. NEEDLE HOLDER, 30CM, S SHAPE



Needle Holders

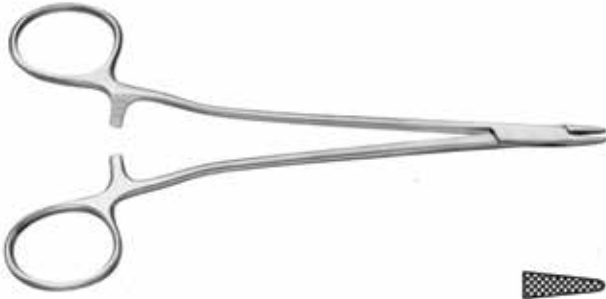

Item Code	Description
ND-07-49	SENNING NEEDLE HOLDER, 17CM, EXTRA DELICATE PATTERN

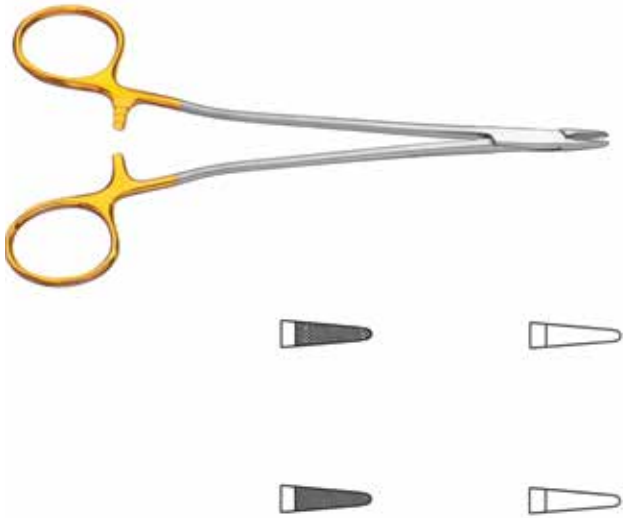

Item Code	Description
ND-07-50	SENNING T.C. NEEDLE HOLDER, 15CM, SMOOTH
ND-07-52	SENNING T.C. NEEDLE HOLDER, 15CM, SERRATED
ND-07-51	SENNING T.C. NEEDLE HOLDER, 17CM, SMOOTH
ND-07-53	SENNING T.C. NEEDLE HOLDER, 17CM, SERRATED

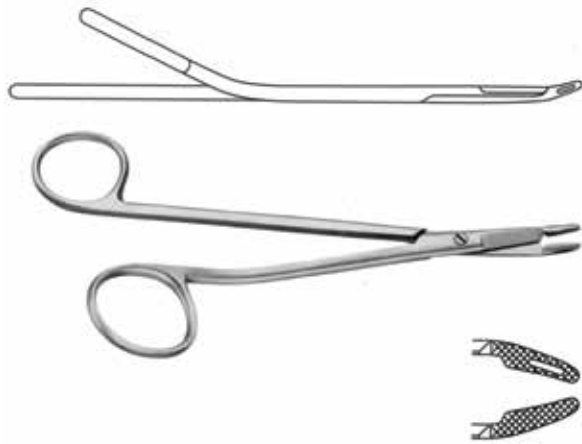

Item Code	Description
ND-07-54	GILLIES SLIM NEEDLE HOLDER WITH SCISSORS, 14.5CM
ND-07-55	GILLIES NEEDLE HOLDER WITH SCISSORS, 15CM

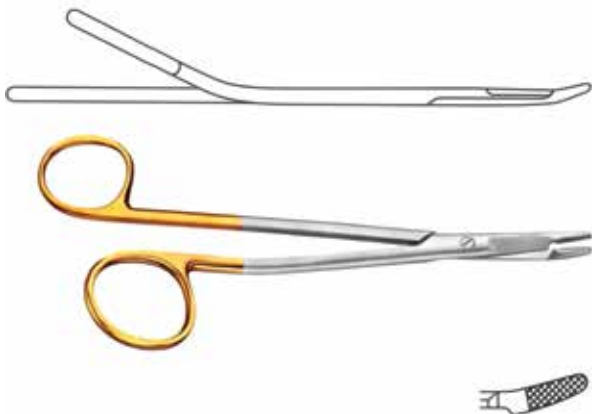

Item Code	Description
ND-07-56	GILLIES SLIM T.C. NEEDLE HOLDER WITH SCISSORS, 14.5CM
ND-07-57	GILLIES T.C. NEEDLE HOLDER WITH SCISSORS, 15CM



Needle Holders



Item Code	Description
ND-07-58	MATHIEU T.C. NEEDLE HOLDER, 14CM
ND-07-59	MATHIEU T.C. NEEDLE HOLDER, 17CM
ND-07-60	MATHIEU T.C. NEEDLE HOLDER, 20CM
ND-07-61	MATHIEU T.C. NEEDLE HOLDER, 24CM



a = 60 mm



a = 90 mm



smooth jaws

Item Code	Description
ND-07-62	COTTLE MASING NEEDLE HOLDER, SMOOTH JAWS, DELICATE, 6CM SHAFT
ND-07-63	COTTLE MASING NEEDLE HOLDER, SMOOTH JAWS, DELICATE, 9CM SHAFT



Item Code	Description
ND-07-64	Corwin Hegar T.C. Wire Twisting Forceps, 16cm



Micro Needle Holders



Item Code	Description
MNH-08-01-01	Castroviejo Needle Holder, Standard, With Catch, 14cm, Straight
MNH-08-01-02	Castroviejo Needle Holder, Standard, With Catch, 14cm, Curved
MNH-08-01-03	Castroviejo Needle Holder, Standard, With Catch, 17cm, Straight
MNH-08-01-04	Castroviejo Needle Holder, Standard, With Catch, 17cm, Curved



Item Code	Description
MNH-08-02-01	Castroviejo Needle Holder, T.C, Standard, With catch, 14cm, Plain
MNH-08-02-02	Castroviejo Needle Holder, T.C, Standard, With catch, 14cm, Serrated
MNH-08-02-03	Castroviejo Needle Holder, T.C, Standard, With catch, 17cm, Plain
MNH-08-02-04	Castroviejo Needle Holder, T.C, Standard, With catch, 17cm, Serrated



Item Code	Description
MNH-08-03-01	Castroviejo Ultra Fine Needle Holder, 14.5 cm, With Catch, Straight
MNH-08-03-02	Castroviejo Ultra Fine Needle Holder, 14.5 cm, With Catch, Curved



Item Code	Description
MNH-08-04-01	Castroviejo Ultra Fine Needle Holder, 14.5 cm, Without Catch, Straight
MNH-08-04-02	Castroviejo Ultra Fine Needle Holder, 14.5 cm, Without Catch, Curved

Micro Needle Holders



Item Code	Description
MNH-08-05-01	Barraquer Needle Holder, Round Handle, Without Catch, 11.5cm, Straight
MNH-08-05-02	Barraquer Needle Holder, Round Handle, Without Catch, 11.5cm, Curved
MNH-08-05-03	Barraquer Needle Holder, Round Handle, Without Catch, 14cm, Straight
MNH-08-05-04	Barraquer Needle Holder, Round Handle, Without Catch, 14cm, Curved



Item Code	Description
MNH-08-06-01	Barraquer Needle Holder, Round Handle, With Catch, 11.5cm, Straight
MNH-08-06-02	Barraquer Needle Holder, Round Handle, With Catch, 11.5cm, Curved
MNH-08-06-03	Barraquer Needle Holder, Round Handle, With Catch, 14cm, Straight
MNH-08-06-04	Barraquer Needle Holder, Round Handle, With Catch, 14cm, Curved



Retractors

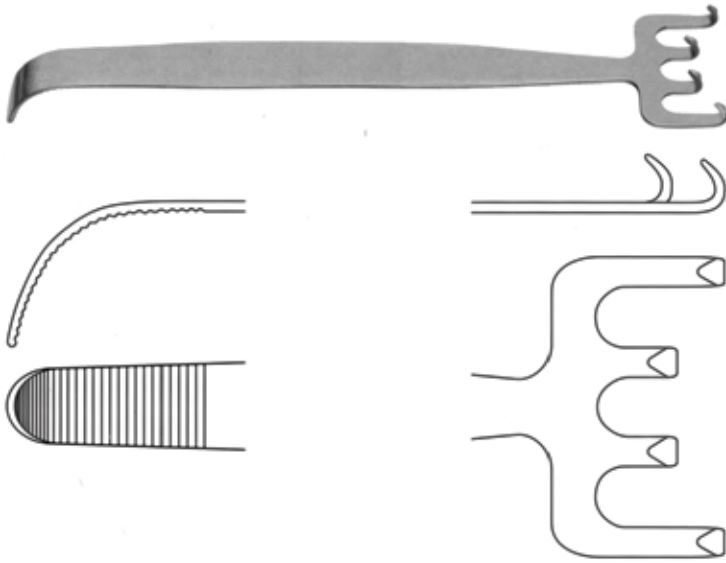

Item Code Description

R-09-03 WALTER RETRACTOR, 19CM, 4 PRONGS

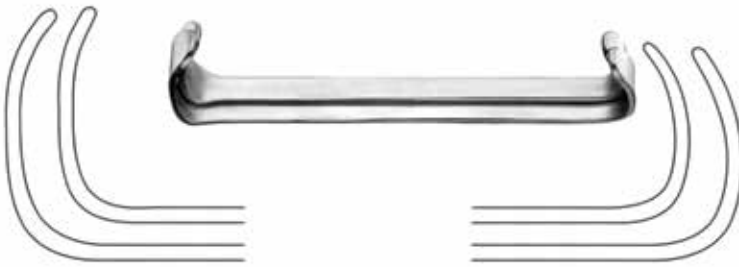

Item Code Description

R-09-01 FARABEUFBABY RETRACTORS, 12CM,
DOUBLE ENDED, SET OF 2



Item Code Description

R-09-02 FARABEUFBABY RETRACTORS, 15CM, DOUBLE
ENDED, SET OF 2



Retractors

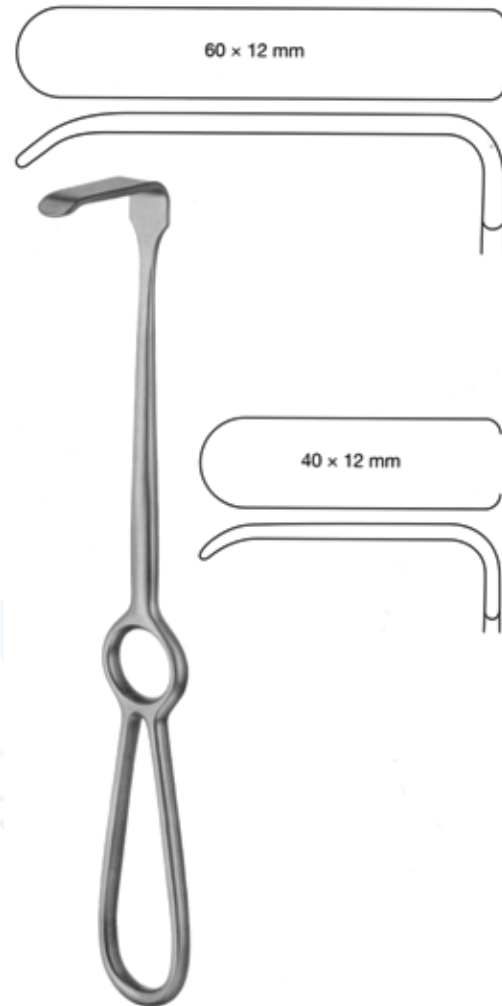
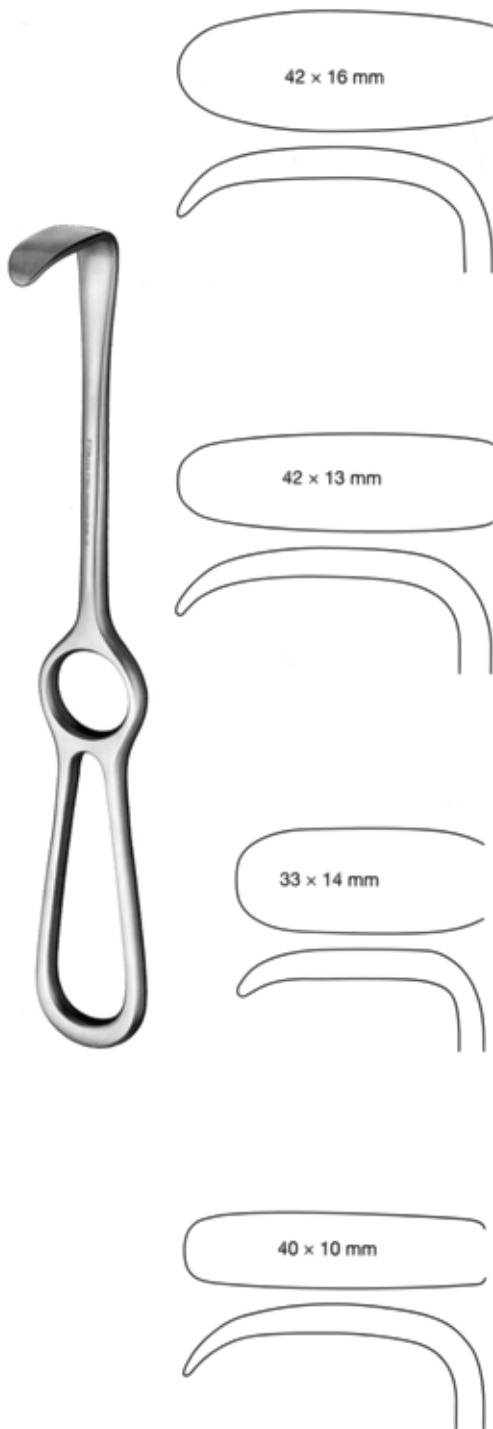

Item Code	Description
R-09-08	KOCHER RETRACTOR #1, 12MM WIDE X 40MM DEEP, 21CM
R-09-09	KOCHER RETRACTOR #2, 12MM WIDE X 60MM DEEP, 21CM

Item Code	Description
R-09-04	LANGENBECK RETRACTOR, 10MM WIDE X 40MM DEEP, 21CM
R-09-05	LANGENBECK RETRACTOR, 14MM WIDE X 33MM DEEP, 21CM
R-09-06	LANGENBECK RETRACTOR, 13MM WIDE X 42MM DEEP, 21CM
R-09-07	LANGENBECK RETRACTOR, 16MM WIDE X 42MM DEEP, 21CM



Retractors

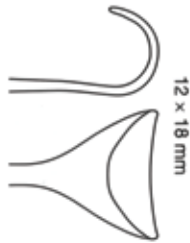

Item Code	Description
R-09-15	DESMARRES LID RETRACTOR #0, 14CM, PEDIATRIC, 8X10MM
R-09-16	DESMARRES LID RETRACTOR #1, 14CM, SMALL, 9X12MM
R-09-17	DESMARRES LID RETRACTOR #2, 14CM, MEDIUM, 10X14MM
R-09-18	DESMARRES LID RETRACTOR #3, 14CM, LARGE, 10X16MM
R-09-19	DESMARRES LID RETRACTOR #4, 14CM, EXTRA LARGE, 12X18MM

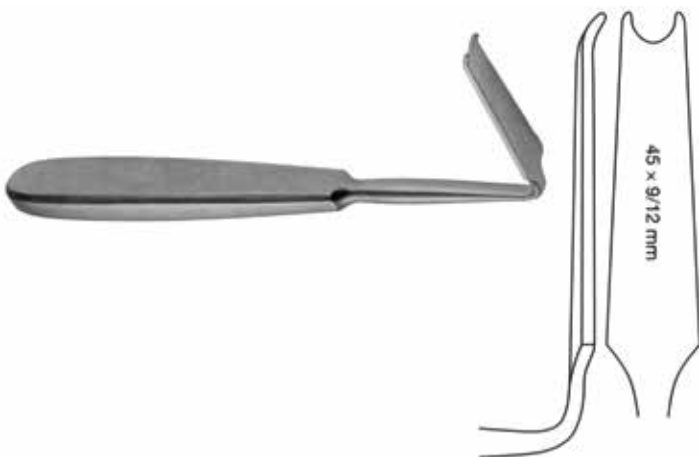

Item Code	Description
R-09-34	OBWEGESER MANDIBULAR RIM RETRACTOR, 17CM, 9/12 X 45MM

Retractors

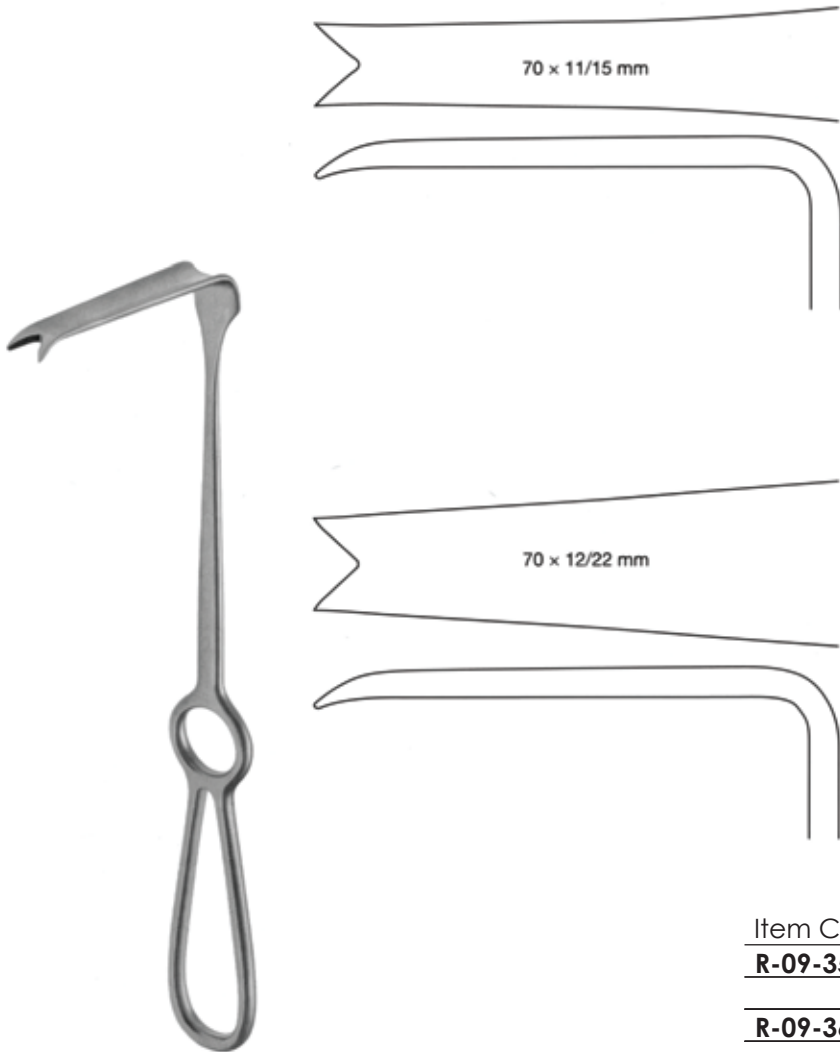

ZIMAIZ
INTERNATIONAL

Item Code	Description
R-09-35	OBWEGESER RAMUS RETRACTOR, 22CM, 11/15 X 70MM
R-09-36	OBWEGESER RAMUS RETRACTOR, 22CM, 12/22 X 70MM



Retractors

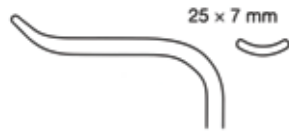
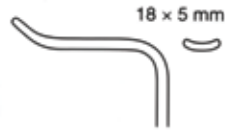

IZ
ONAL

Item Code	Description
R-09-20	OBWEGESER SOFT TISSUE RETRACTOR, 23CM, 5X18MM, CURVED UP
R-09-21	OBWEGESER SOFT TISSUE RETRACTOR, 23CM, 7X25MM, CURVED UP
R-09-22	OBWEGESER SOFT TISSUE RETRACTOR, 23CM, 10X35MM, CURVED UP
R-09-23	OBWEGESER SOFT TISSUE RETRACTOR, 23CM, 10X42MM, CURVED UP
R-09-24	OBWEGESER SOFT TISSUE RETRACTOR, 23CM, 12X55MM, CURVED UP
R-09-25	OBWEGESER SOFT TISSUE RETRACTOR, 23CM, 14X70MM, CURVED UP
R-09-26	OBWEGESER SOFT TISSUE RETRACTOR, 23CM, 16X80MM, CURVED UP

Retractors

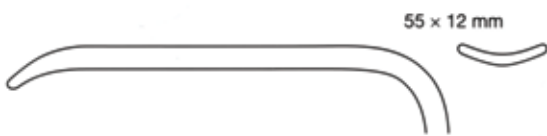
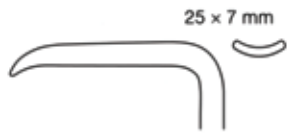
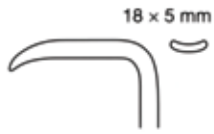

Item Code	Description
R-09-27	OBWEGESER SOFT TISSUE RETRACTOR, 23CM, 5X18MM, CURVED DOWN
R-09-28	OBWEGESER SOFT TISSUE RETRACTOR, 23CM, 7X25MM, CURVED DOWN
R-09-29	OBWEGESER SOFT TISSUE RETRACTOR, 23CM, 10X35MM, CURVED DOWN
R-09-30	OBWEGESER SOFT TISSUE RETRACTOR, 23CM, 10X42MM, CURVED DOWN
R-09-31	OBWEGESER SOFT TISSUE RETRACTOR, 23CM, 12X55MM, CURVED DOWN
R-09-32	OBWEGESER SOFT TISSUE RETRACTOR, 23CM, 14X70MM, CURVED DOWN
R-09-33	OBWEGESER SOFT TISSUE RETRACTOR, 23CM, 16X80MM, CURVED DOWN



Retractors



Item Code	Description
R-09-37	OBWEGESER ALVEOLAR (WISDOM TOOTH) RETRACTOR, 22CM, 13/23 X 70MM

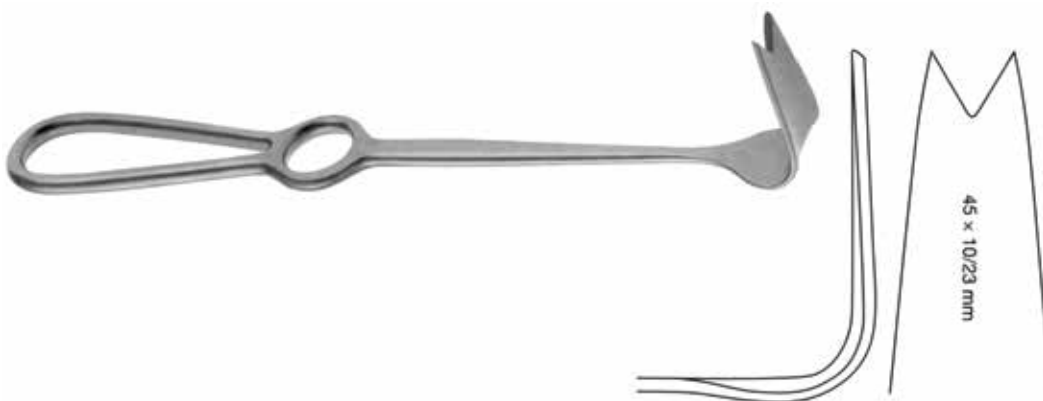

Item Code	Description
R-09-38	OBWEGESER NASAL SPINE RETRACTOR, 22CM, 10/23 X 45MM

Retractors

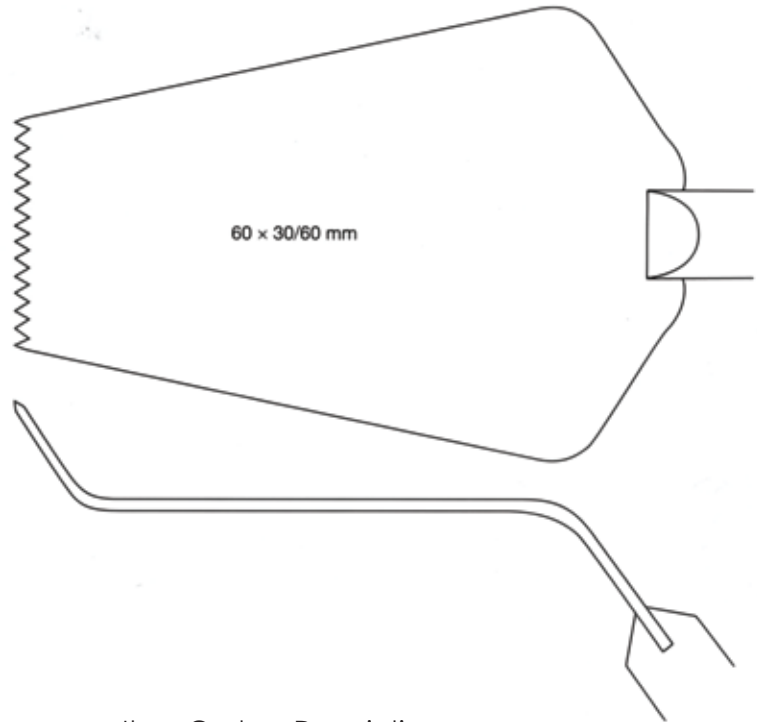

Item Code	Description
R-09-39	OBWEGESER ILIAC CREST RETRACTOR, 22CM, 30/60 X 60MM

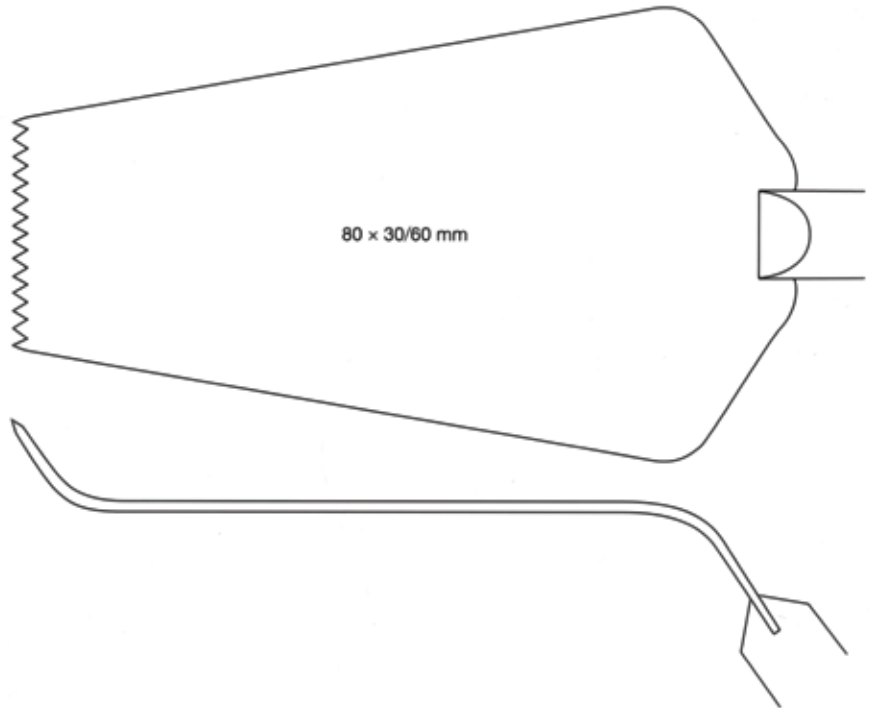

Item Code	Description
R-09-40	OBWEGESER ILIAC CREST RETRACTOR, 22CM, 30/60 X 80MM



Retractors

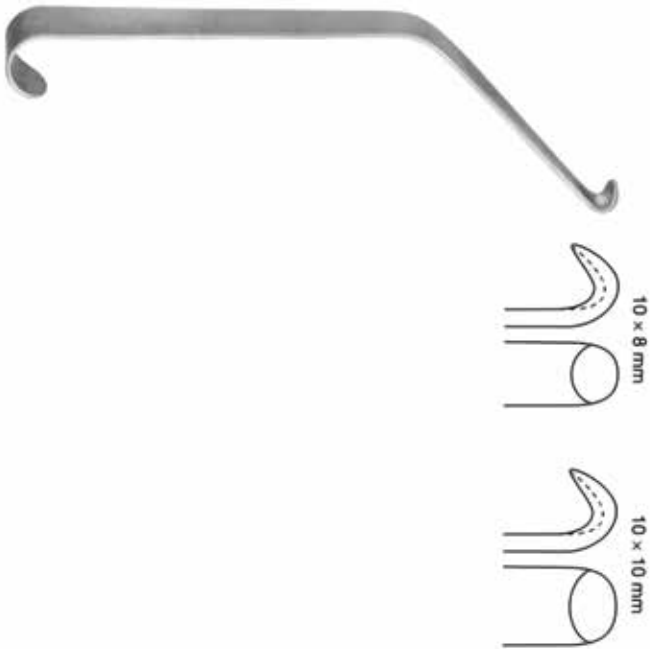

Item Code	Description
R-09-41	OBWEGESER MANDIBULAR CHANNEL RETRACTOR, 17.5CM, 8MM
R-09-42	OBWEGESER MANDIBULAR CHANNEL RETRACTOR, 17.5CM, 10MM

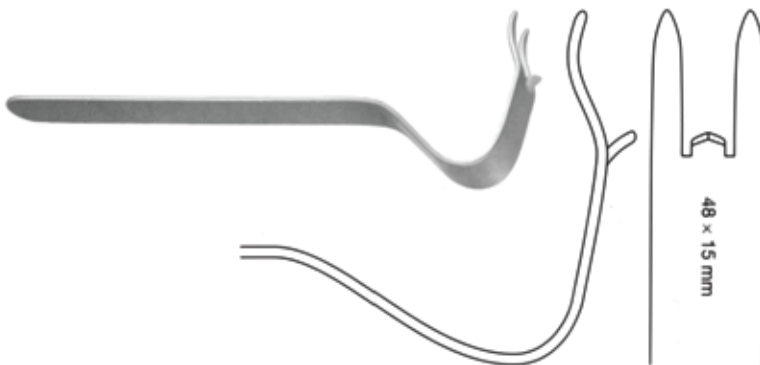

MAIZ
NATIONAL

Item Code	Description
R-09-43	OBWEGESER CHIN RETRACTOR, 16CM



Item Code	Description
R-09-50	SALDANHA SOLZ ABDOMINAL RETRACTOR, 23.5CM

Retractors



Item Code	Description
R-09-51	Coronal Brow Lift 7 Prongs Retractor, 18 cm



Item Code	Description
R-09-52	Anderson Bear Claw Retractor, 12 cm



Item Code	Description
R-09-57-01	Sculpo Breast Retractors, 180 X 25mm Blade Size, With 5mm Endoscopic Scope Sheath
R-09-57-02	Sculpo Breast Retractors, 180 X 25mm Blade Size, With 10mm Endoscopic Scope Sheath



Retractors



Item Code Description

R-09-58	Killian Nasal Speculum With Fiber Optics Illumination
----------------	---



Item Code Description

R-09-59-01	Freeman Flap Retractor With Fiber Optics Illumination, 20cm, 13mm
-------------------	---

R-09-59-02	Freeman Flap Retractor With Fiber Optics Illumination, 20cm, 25mm
-------------------	---



Item Code Description

R-09-60-01	Deaver Retractor With Fiber Optics Illumination, 16mm
-------------------	---

R-09-60-02	Deaver Retractor With Fiber Optics Illumination, 25mm
-------------------	---

Retractors



Item Code	Description
R-09-61	Ferreira Face Lift Retractor With Fiber Optic Illumination 22 X 108mm



Item Code	Description
R-09-62	Ring breast retractor with fiber optic illumination and irrigation tube



Delicate Retractors

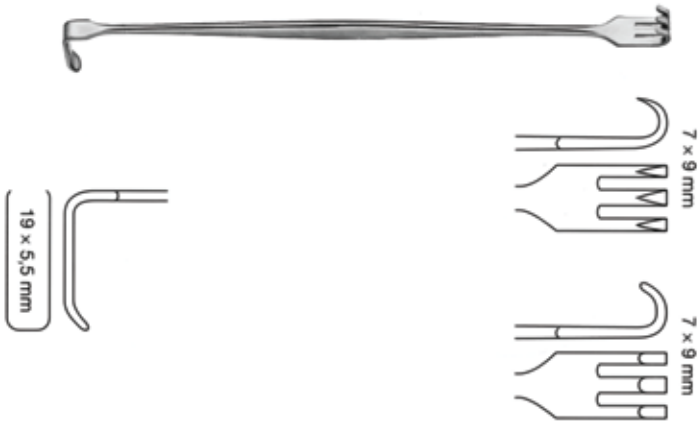

Item Code Description

DR-10-01 SENN MILLER RETRACTOR, 16CM, SHARP

DR-10-02 SENN MILLER RETRACTOR, 16CM, BLUNT



Item Code Description

DR-10-03 RAGNELL DOUBLE ENDED RETRACTOR, 16CM



Item Code Description

DR-10-04 COPE RETRACTOR, 18CM, DOUBLE ENDED, 6MM/11MM

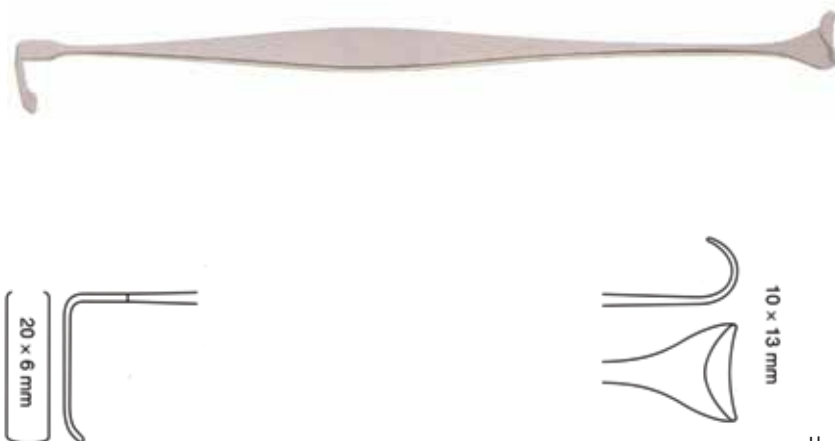

Item Code Description

DR-10-05 WALTER COPE RETRACTOR, 17.5CM

Delicate Retractors

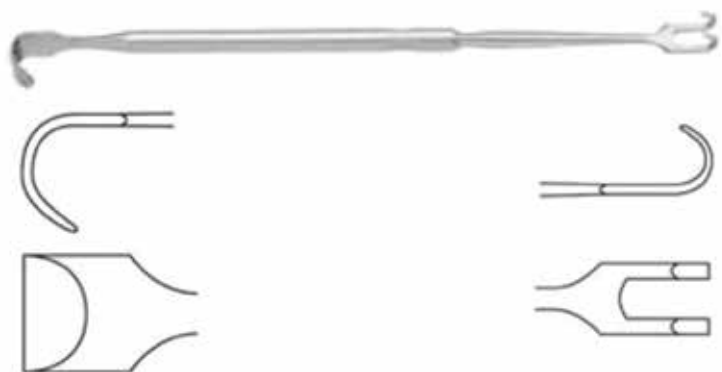

Item Code	Description
DR-10-06	JACKSON TRACHEAL RETRACTOR, 17CM, DOUBLE ENDED

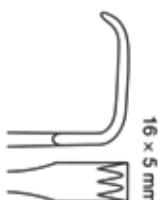
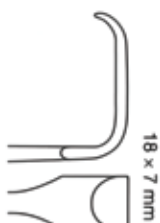
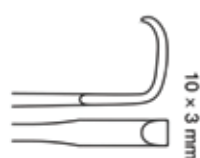

MAIZ
INTERNATIONAL

Item Code	Description
DR-10-07	MEYERDING RETRACTOR, 18CM, 7X18MM
DR-10-08	MEYERDING RETRACTOR, 18CM, TOOTHED, 5X16MM
DR-10-09	MEYERDING RETRACTOR, 18CM, TOOTHED, 4X7MM
DR-10-10	MEYERDING RETRACTOR, 18CM, 3X10MM
DR-10-11	MEYERDING RETRACTOR, 18CM, CONCAVE BLADE, 4X7MM
DR-10-12	MEYERDING RETRACTOR, 18CM, 3 PRONGS, 4X10MM



Delicate Retractors

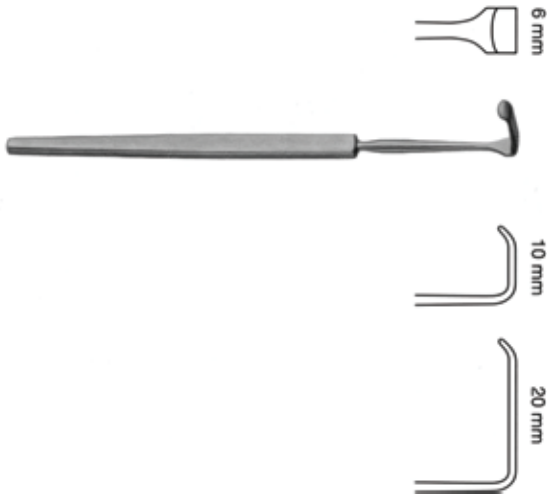

Item Code	Description
DR-10-13	SENN GREEN RETRACTOR, 14CM, 6X10MM
DR-10-15	SENN GREEN RETRACTOR, 14CM, 6X20MM



Item Code	Description
DR-10-14	LANZ RETRACTOR, 18CM, 3X15MM

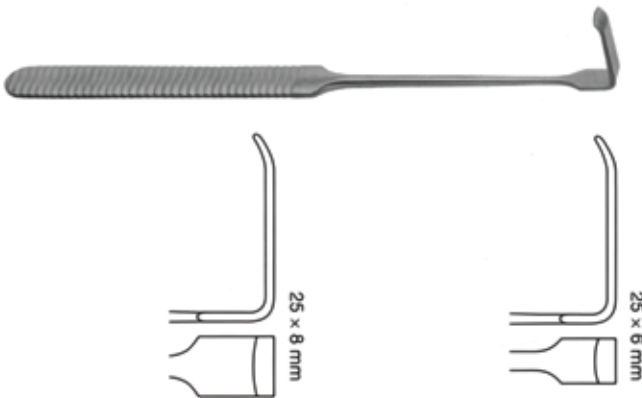

Item Code	Description
DR-10-16	LANGENBECK GREEN RETRACTOR, 17CM, 6X25MM
DR-10-17	LANGENBECK GREEN RETRACTOR, 17CM, 8X25MM

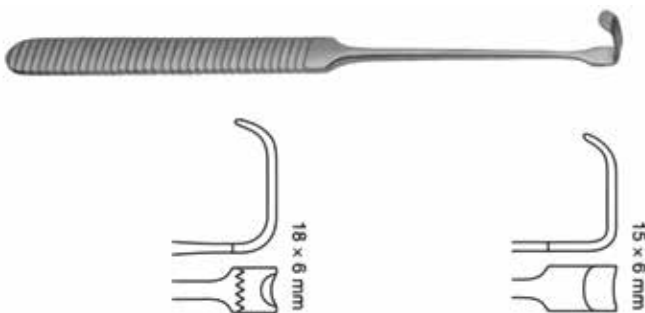

Item Code	Description
DR-10-18	STRANDELL STILLE RETRACTOR, 17CM, BLUNT, 6X15MM
DR-10-19	STRANDELL STILLE RETRACTOR, 17CM, TOOTHED, 6X15MM

Delicate Retractors



Item Code	Description
DR-10-23	FRAZIER DURA AND SKIN RETRACTOR HOOK, 12.5CM, 3MM



Item Code	Description
DR-10-26	STRAIGHT SKIN HOOK, 13CM, STRAIGHT, 4MM



Item Code	Description
DR-10-27	LAHEY CLINIC DURA RETRACTOR HOOK, 13CM, 2MM



Item Code	Description
DR-10-20	ADSON HOOK, 20CM, SHARP, 3MM
DR-10-21	ADSON HOOK, 20CM, BLUNT, 3MM



Item Code	Description
DR-10-24	GILLIES DURA AND SKIN RETRACTOR HOOK, 19CM, SMALL
DR-10-25	GILLIES DURA AND SKIN RETRACTOR HOOK, 19CM, LARGE



Item Code	Description
DR-10-29	HUMBY SWIVEL SKIN HOOK, 11.5CM, 2 PRONGS, 3MM



Delicate Retractors



Item Code	Description
DR-10-28-01	BARSKY SKIN HOOK, 15CM, SHARP, Single Prong
DR-10-28-02	BARSKY SKIN HOOK, 15CM, SHARP, Double Prong



Item Code	Description
DR-10-36	KLEINERT KUTZ SKIN HOOK, 13CM, SHARP, SMALL, 3MM WIDE
DR-10-37	KLEINERT KUTZ SKIN HOOK, 13CM, SHARP, MEDIUM, 5MM WIDE
DR-10-38	KLEINERT KUTZ SKIN HOOK, 13CM, SHARP, LARGE, 7MM WIDE



Item Code	Description
DR-10-30	CKSON TRACHEAL TENACULUM , 14.5CM, SINGLE, 9MM



Item Code	Description
DR-10-31	NEWS TRACHEOTOMY HOOK, 15CM, SINGLE, 10MM

Delicate Retractors



Item Code	Description
DR-10-32	COTTLE TENACULUM HOOK, 16CM, ANGLED, 7MM



Item Code	Description
DR-10-33	EMMETT TENACULUM HOOK #1, 22CM, SHARP, 6MM



Item Code	Description
DR-10-34	BERGMANN RETRACTOR HOOK, 14CM, SINGLE PRONG, SHARP, 8MM



Item Code	Description
DR-10-35	HOOK RETRACTOR, 16.5CM, SINGLE PRONG, SHARP, 11MM



Item Code	Description
DR-10-39	BERNICKE RETRACTOR, 19CM, 8MM, SHARP, S SHAPED TIP
DR-10-40	BERNICKE RETRACTOR, 19CM, 8MM, BLUNT, S SHAPED TIP



Delicate Retractors



Item Code	Description
DR-10-41	JOSEPH SKIN HOOK, 16CM, SINGLE PRONG, SHARP, 5MM



Item Code	Description
DR-10-46	FREER DOUBLE HOOK, 15CM, SHARP, 3MM WIDE

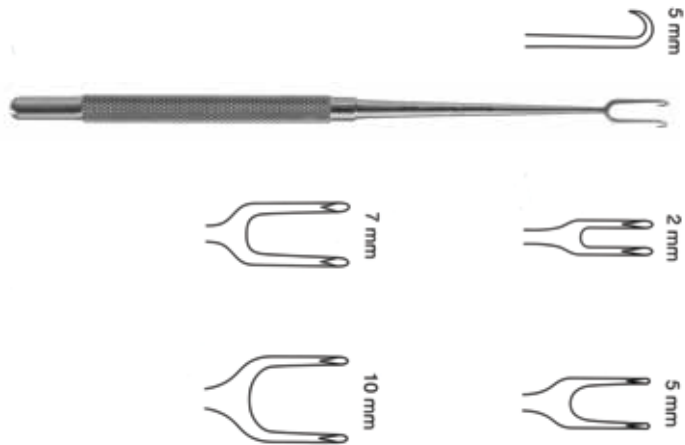

MAIZ

Item Code	Description
DR-10-42	JOSEPH SKIN HOOK, 16CM, DOUBLE PRONG, SHARP, 2MM WIDE
DR-10-43	JOSEPH DELICATE RETRACTOR, 17CM, 2 PRONG, 5MM, SHARP
DR-10-44	JOSEPH SKIN HOOK, DOUBLE PRONG, SHARP, 17CM, 7MM WIDE
DR-10-45	JOSEPH SKIN HOOK, DOUBLE PRONG, SHARP, 16CM, 10MM WIDE

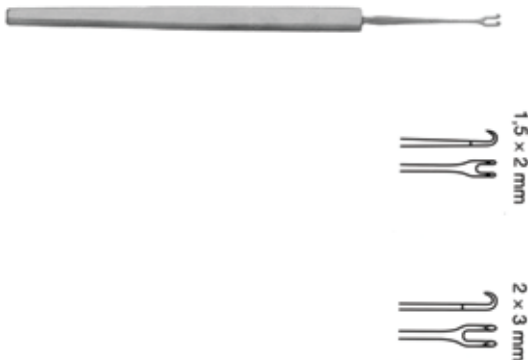

Item Code	Description
DR-10-47	GUTHRIE DOUBLE RETRACTOR HOOK, 13CM, SHARP, 1.5MM X 2MM WIDE
DR-10-48	GUTHRIE DOUBLE RETRACTOR HOOK, 13CM, SHARP, 2MM X 3MM WIDE



Delicate Retractors

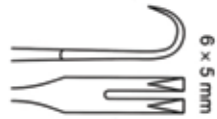

Item Code Description

DR-10-49	RETRACTOR, SINGLE PRONG, SHARP, 17CM
DR-10-50	RETRACTOR, 2 PRONGS, SHARP, 5MM WIDE, 17CM
DR-10-51	RETRACTOR, 3 PRONG, SHARP, 8MM WIDE, 17CM
DR-10-52	RETRACTOR, 4 PRONG, SHARP, 11MM WIDE, 17CM



Item Code Description

DR-10-57	FLEXIBLE NECK RETRACTOR, 16CM, 2 PRONG, SHARP, 4MM WIDE
DR-10-58	FLEXIBLE NECK RETRACTOR, 16CM, 3 PRONG, SHARP, 7MM WIDE
DR-10-59	FLEXIBLE NECK RETRACTOR, 16CM, 2 PRONG, BLUNT, 4MM WIDE
DR-10-60	FLEXIBLE NECK RETRACTOR, 16CM, 3 PRONG, BLUNT, 7MM WIDE



Self Retaining Retractors

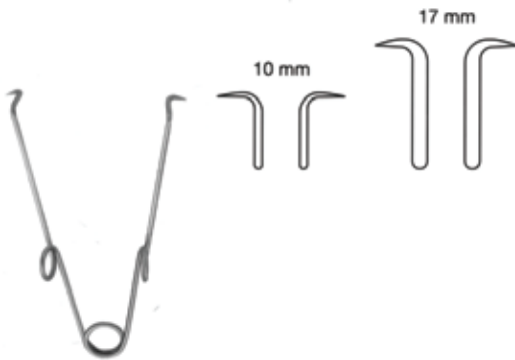

Item Code Description

SRR-11-01	SPRING RETRACTOR, 8.5CM, 1X1 SHARP PRONGS
SRR-11-02	SPRING RETRACTOR, 11.5CM, 1X1 SHARP PRONGS
SRR-11-03	SPRING RETRACTOR, 8.5CM, 3X3 BLUNT PRONGS
SRR-11-04	SPRING RETRACTOR, 11.5CM, 3X3 BLUNT PRONGS

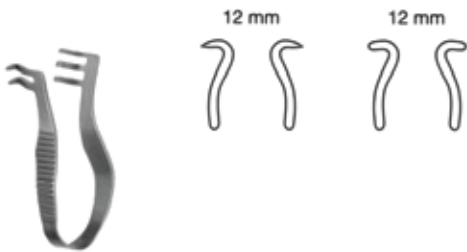

Item Code Description

SRR-11-06	FINSEN RETRACTOR, 5CM, 2X3 SHARP PRONGS
SRR-11-07	FINSEN RETRACTOR, 5CM, 2X3 BLUNT PRONGS

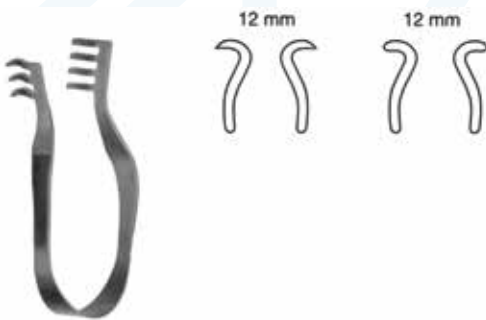

Item Code Description

SRR-11-08	FINSEN RETRACTOR, 7CM, 3X4 SHARP PRONGS
SRR-11-09	FINSEN RETRACTOR, 7CM, 3X4 BLUNT PRONGS

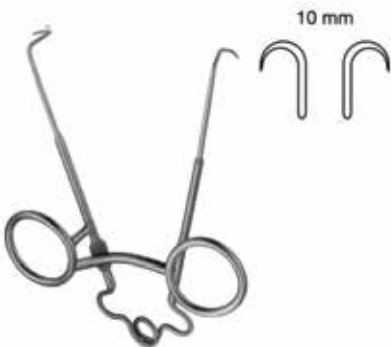

Item Code Description

SRR-11-05	SPRING RETRACTOR, 10.5CM, 1X1 SHARP PRONGS, WITH RATCHET
------------------	--



Self Retaining Retractors

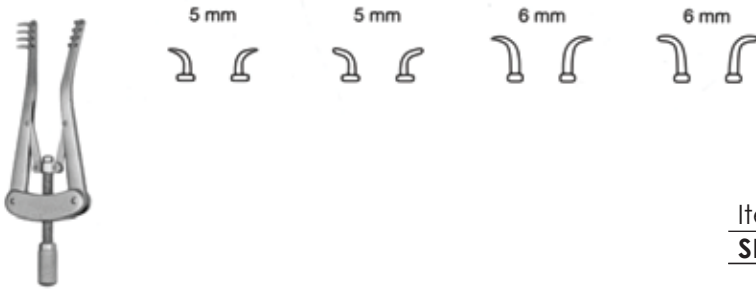

Item Code	Description
SRR-11-14	ALM RETRACTOR, 7CM, 4X4 SHARP PRONGS, 5MM DEEP
SRR-11-15	ALM RETRACTOR, 7CM, 4X4 BLUNT PRONGS, 5MM DEEP
SRR-11-16	ALM RETRACTOR, 10CM, 4X4 SHARP PRONGS, 6MM DEEP
SRR-11-17	ALM RETRACTOR, 10CM, 4X4 BLUNT PRONGS, 6MM DEEP

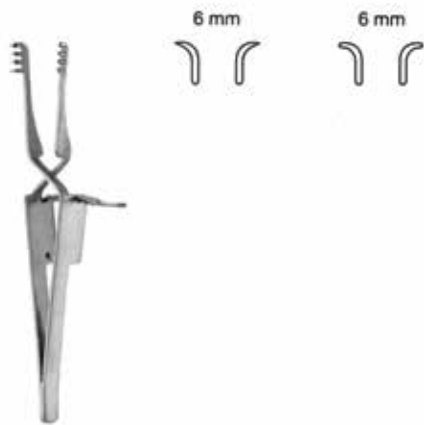

ZIMAIZ
INTERNATIONAL

Item Code	Description
SRR-11-12	SKIN RETRACTOR, 10CM, CROSS ACTION, 4X4 SHARP PRONGS
SRR-11-13	SKIN RETRACTOR, 10CM, CROSS ACTION, 4X4 BLUNT PRONGS

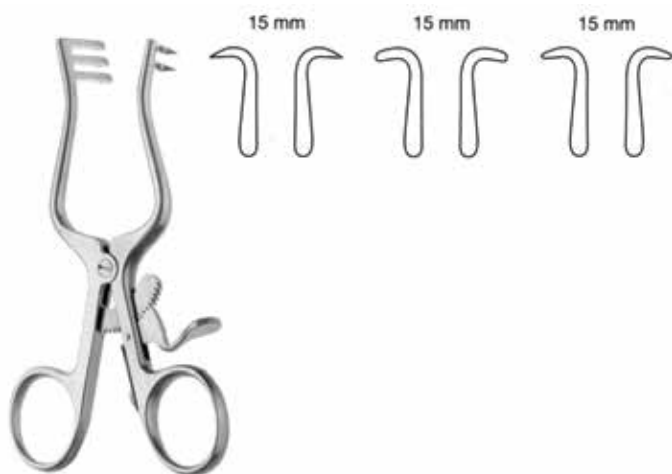

Item Code	Description
SRR-11-19	WEITLANER RETRACTOR, 2X3 SHARP PRONGS, 15MM DEEP, 10.5CM
SRR-11-20	WEITLANER RETRACTOR, 2X3 BLUNT PRONGS, 15MM DEEP, 10.5CM
SRR-11-21	WEITLANER RETRACTOR, 2X3 SEMI SHARP PRONGS, 15MM DEEP, 10.5CM



Self Retaining Retractors

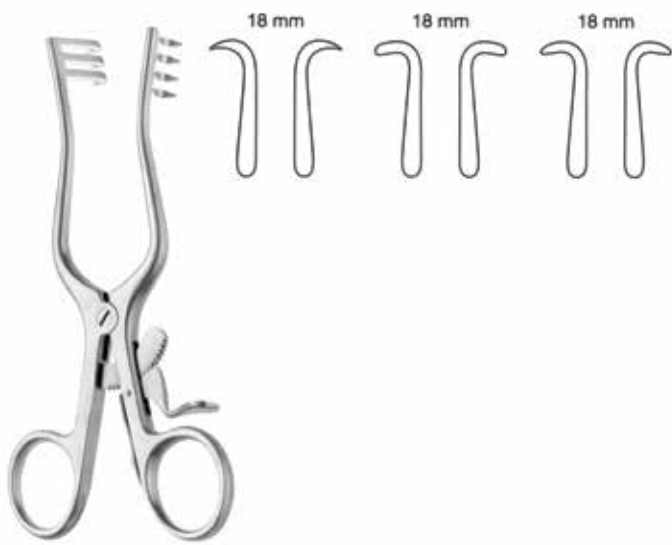

Item Code Description

SRR-11-25 WEITLANER RETRACTOR, 3X4 SHARP PRONGS, 18MM DEEP, 16.5CM

SRR-11-26 WEITLANER RETRACTOR, 3X4 BLUNT PRONGS, 18MM DEEP, 16.5CM

SRR-11-27 WEITLANER RETRACTOR, 3X4 SEMI-SHARP PRONGS, 18MM DEEP, 16.5CM



ZIMAIZ
INTERNATIONAL

Item Code Description

SRR-11-18 WEITLANER RETRACTOR, SOLID BLADES, 18MM DEEP, 13CM

Scalpel Handles



Item Code Description

BH-12-09 SCALPEL HANDLE, #3 STANDARD



Item Code Description

BH-12-10 SCALPEL HANDLE, #7



Item Code Description

BH-12-11 SCALPEL HANDLE, #3 LONG



Item Code Description

BH-12-12 SCALPEL HANDLE, #7K SHORT



Item Code Description

BH-12-14 SCALPEL HANDLE, #3LA LONG ANGLED



Item Code Description

BH-12-16 SCALPEL, ROUND HANDLE, 16CM



Item Code Description

BH-12-17 SCALPEL HANDLE, LONG SLIM, 22.5CM



Item Code Description

BH-12-18 SCALPEL, ROUND HANDLE, LONG, 27CM



Scalpel Handles



Item Code	Description
BH-12-19	SCALPEL HANDLE, BAYONET TYPE, 21CM



Item Code	Description
BH-12-20	SCALPEL HANDLE, #4L LONG



Item Code	Description
BH-12-30	SCALPEL HANDLE, #3, WITH SCALE



ZIMAIZ
INTERNATIONAL

Delicate Scissors



Item Code	Description
DS-13-01-01	DELICATE SCISSORS, 11CM, STRAIGHT
DS-13-01-02	DELICATE SCISSORS, 11CM, CURVED
DS-13-01-03	DELICATE SCISSORS, 11CM, STRAIGHT, SUPERCUT
DS-13-01-04	DELICATE SCISSORS, 11CM, CURVED, SUPERCUT

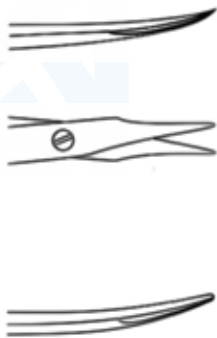

Item Code	Description
DS-13-36-01	STEVENS RIBBON SCISSORS, 10CM, STRAIGHT, SHARP
DS-13-36-02	STEVENS RIBBON SCISSORS, 10CM, STRAIGHT, BLUNT
DS-13-36-03	STEVENS RIBBON SCISSORS, 10CM, CURVED, SHARP
DS-13-36-04	STEVENS RIBBON SCISSORS, 10CM, CURVED, BLUNT

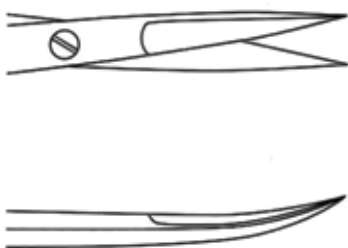
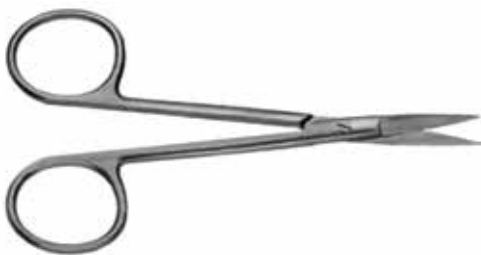

Item Code	Description
DS-13-03-01	JABELEY SCISSORS, 13CM, STRAIGHT
DS-13-03-02	JABELEY SCISSORS, 13CM, CURVED
DS-13-03-03	JABELEY SCISSORS, 13CM, STRAIGHT, SUPERCUT
DS-13-03-04	JABELEY SCISSORS, 13CM, CURVED, SUPERCUT



Delicate Scissors



Item Code Description

DS-13-05-01 IRIS SCISSORS, 9CM, STRAIGHT

DS-13-05-02 IRIS SCISSORS, 10.5CM, STRAIGHT

DS-13-05-03 IRIS SCISSORS, 11.5CM, STRAIGHT

DS-13-05-04 IRIS SCISSORS, 12.5CM, STRAIGHT



DS-13-05-09 IRIS SCISSORS, 9CM, STRAIGHT, SUPERCUT

DS-13-05-10 IRIS SCISSORS, 10.5CM, STRAIGHT, SUPERCUT

DS-13-05-11 IRIS SCISSORS, 11.5CM, STRAIGHT, SUPERCUT

DS-13-05-12 IRIS SCISSORS, 12.5CM, STRAIGHT, SUPERCUT



DS-13-05-17 IRIS SCISSORS, 9CM, STRAIGHT, TC

DS-13-05-18 IRIS SCISSORS, 10.5CM, STRAIGHT, TC

DS-13-05-19 IRIS SCISSORS, 11.5CM, STRAIGHT, TC

DS-13-05-20 IRIS SCISSORS, 12.5CM, STRAIGHT, TC



DS-13-05-25 IRIS SCISSORS, 9CM, STRAIGHT, SUPERCUT PLUS

DS-13-05-26 IRIS SCISSORS, 10.5CM, STRAIGHT, SUPERCUT PLUS

DS-13-05-27 IRIS SCISSORS, 11.5CM, STRAIGHT, SUPERCUT PLUS

DS-13-05-28 IRIS SCISSORS, 12.5CM, STRAIGHT, SUPERCUT PLUS

DS-13-05-33 IRIS SCISSORS, 9CM, STRAIGHT, MAGIC CUT

DS-13-05-34 IRIS SCISSORS, 10.5CM, STRAIGHT, MAGIC CUT

DS-13-05-35 IRIS SCISSORS, 11.5CM, STRAIGHT, MAGIC CUT

DS-13-05-36 IRIS SCISSORS, 12.5CM, STRAIGHT, MAGIC CUT



Item Code Description

DS-13-05-05 IRIS SCISSORS, 9CM, CURVED

DS-13-05-06 IRIS SCISSORS, 10.5CM, CURVED

DS-13-05-07 IRIS SCISSORS, 11.5CM, CURVED

DS-13-05-08 IRIS SCISSORS, 12.5CM, CURVED



DS-13-05-13 IRIS SCISSORS, 9CM, CURVED, SUPERCUT

DS-13-05-14 IRIS SCISSORS, 10.5CM, CURVED, SUPERCUT

DS-13-05-15 IRIS SCISSORS, 11.5CM, CURVED, SUPERCUT

DS-13-05-16 IRIS SCISSORS, 12.5CM, CURVED, SUPERCUT



DS-13-05-21 IRIS SCISSORS, 9CM, CURVED, TC

DS-13-05-22 IRIS SCISSORS, 10.5CM, CURVED, TC

DS-13-05-23 IRIS SCISSORS, 11.5CM, CURVED, TC

DS-13-05-24 IRIS SCISSORS, 12.5CM, CURVED, TC



DS-13-05-29 IRIS SCISSORS, 9CM, CURVED, SUPERCUT PLUS

DS-13-05-30 IRIS SCISSORS, 10.5CM, CURVED, SUPERCUT PLUS

DS-13-05-31 IRIS SCISSORS, 11.5CM, CURVED, SUPERCUT PLUS

DS-13-05-32 IRIS SCISSORS, 12.5CM, CURVED, SUPERCUT PLUS



DS-13-05-37 IRIS SCISSORS, 9CM, CURVED, MAGIC CUT

DS-13-05-38 IRIS SCISSORS, 10.5CM, CURVED, MAGIC CUT

DS-13-05-39 IRIS SCISSORS, 11.5CM, CURVED, MAGIC CUT

DS-13-05-40 IRIS SCISSORS, 12.5CM, CURVED, MAGIC CUT

Delicate Scissors



Item Code	Description
DS-13-34-01	STEVENS SCISSORS, 11.5CM, STRAIGHT, SHARP
DS-13-34-02	STEVENS SCISSORS, 11.5CM, CURVED, SHARP
DS-13-34-03	STEVENS SCISSORS, 11.5CM, STRAIGHT, BLUNT
DS-13-34-04	STEVENS SCISSORS, 11.5CM, CURVED, BLUNT
DS-13-34-05	STEVENS SCISSORS, 11.5CM, STRAIGHT, SHARP, SUPERCUT
DS-13-34-06	STEVENS SCISSORS, 11.5CM, CURVED, SHARP, SUPERCUT
DS-13-34-07	STEVENS SCISSORS, 11.5CM, STRAIGHT, BLUNT, SUPERCUT
DS-13-34-08	STEVENS SCISSORS, 11.5CM, CURVED, BLUNT, SUPERCUT
DS-13-34-09	STEVENS SCISSORS, 11.5CM, STRAIGHT, SHARP, TC
DS-13-34-10	STEVENS SCISSORS, 11.5CM, CURVED, SHARP, TC
DS-13-34-11	STEVENS SCISSORS, 11.5CM, STRAIGHT, BLUNT, TC
DS-13-34-12	STEVENS SCISSORS, 11.5CM, CURVED, BLUNT, TC
DS-13-34-13	STEVENS SCISSORS, 11.5CM, STRAIGHT, SHARP, SUPERCUT PLUS
DS-13-34-14	STEVENS SCISSORS, 11.5CM, CURVED, SHARP, SUPERCUT PLUS
DS-13-34-15	STEVENS SCISSORS, 11.5CM, STRAIGHT, BLUNT, SUPERCUT PLUS
DS-13-34-16	STEVENS SCISSORS, 11.5CM, CURVED, BLUNT, SUPERCUT PLUS
DS-13-34-17	STEVENS SCISSORS, 11.5CM, STRAIGHT, SHARP, MAGIC CUT
DS-13-34-18	STEVENS SCISSORS, 11.5CM, CURVED, SHARP, MAGIC CUT
DS-13-34-19	STEVENS SCISSORS, 11.5CM, STRAIGHT, BLUNT, MAGIC CUT
DS-13-34-20	STEVENS SCISSORS, 11.5CM, CURVED, BLUNT, MAGIC CUT



Item Code	Description
DS-13-101-01	IRIS SCISSORS 11.5CM, BIG RING, SUPERCUT, STRAIGHT
DS-13-101-02	IRIS SCISSORS 11.5CM, BIG RING, SUPERCUT, CURVED



Item Code	Description
DS-13-09-01	MICRO IRIS SCISSORS, 9CM, STRAIGHT
DS-13-09-02	MICRO IRIS SCISSORS, 9CM, CURVED
DS-13-09-03	MICRO IRIS SCISSORS, 9CM, STRAIGHT, SUPERCUT
DS-13-09-04	MICRO IRIS SCISSORS, 9CM, CURVED, SUPERCUT



Delicate Dissecting Scissors



Item Code	Description
DS-13-23-01	LEXER KNAPP BABY SCISSORS, 10CM, STRAIGHT
DS-13-23-02	LEXER KNAPP BABY SCISSORS, 10CM, CURVED
DS-13-23-03	LEXER KNAPP BABY SCISSORS, 10CM, STRAIGHT, SUPERCUT
DS-13-23-04	LEXER KNAPP BABY SCISSORS, 10CM, CURVED, SUPERCUT
DS-13-23-05	LEXER KNAPP BABY SCISSORS, 10CM, STRAIGHT, TC
DS-13-23-05	LEXER KNAPP BABY SCISSORS, 10CM, CURVED, TC



Item Code	Description
DS-13-10-01	KNAPP SCISSORS, 12CM, STRAIGHT, SHARP
DS-13-10-02	KNAPP SCISSORS, 12CM, CURVED, SHARP
DS-13-10-03	KNAPP SCISSORS, 12CM, STRAIGHT, BLUNT
DS-13-10-04	KNAPP SCISSORS, 12CM, CURVED, BLUNT
DS-13-10-05	KNAPP SCISSORS, 12CM, STRAIGHT, SHARP, SUPERCUT
DS-13-10-06	KNAPP SCISSORS, 12CM, CURVED, SHARP, SUPERCUT
DS-13-10-07	KNAPP SCISSORS, 12CM, STRAIGHT, BLUNT, SUPERCUT
DS-13-10-08	KNAPP SCISSORS, 12CM, CURVED, BLUNT, SUPERCUT



Item Code	Description
DS-13-31-01	KNAPP RIBBON SCISSORS, 10CM, STRAIGHT
DS-13-31-02	KNAPP RIBBON SCISSORS, 10CM, CURVED

Delicate Dissecting Scissors



Item Code	Description
DS-13-58-01	KNAPP SCISSORS, 12.5CM, STRAIGHT
DS-13-58-02	KNAPP SCISSORS, 12.5CM, CURVED
DS-13-58-03	KNAPP SCISSORS, 12.5CM, STRAIGHT, SUPERCUT
DS-13-58-04	KNAPP SCISSORS, 12.5CM, CURVED, SUPERCUT
DS-13-58-05	KNAPP SCISSORS, 12.5CM, STRAIGHT, TC
DS-13-58-06	KNAPP SCISSORS, 12.5CM, CURVED, TC
DS-13-58-07	KNAPP SCISSORS, 12.5CM, STRAIGHT, SUPERCUT PLUS
DS-13-58-08	KNAPP SCISSORS, 12.5CM, CURVED, SUPERCUT PLUS
DS-13-58-09	KNAPP SCISSORS, 12.5CM, STRAIGHT, MAGIC CUT
DS-13-58-10	KNAPP SCISSORS, 12.5CM, CURVED, MAGIC CUT



Item Code	Description
DDS-14-01-01	DISSECTING SCISSORS, 12CM, STRAIGHT
DDS-14-01-02	DISSECTING SCISSORS, 12CM, CURVED
DDS-14-01-03	DISSECTING SCISSORS, 12CM, STRAIGHT, SUPERCUT
DDS-14-01-04	DISSECTING SCISSORS, 12CM, CURVED, SUPERCUT
DDS-14-01-05	DISSECTING SCISSORS, 12CM, STRAIGHT, TC
DDS-14-01-06	DISSECTING SCISSORS, 12CM, CURVED, TC
DDS-14-01-07	DISSECTING SCISSORS, 12CM, STRAIGHT, SUPERCUT PLUS
DDS-14-01-08	DISSECTING SCISSORS, 12CM, CURVED, SUPERCUT PLUS
DDS-14-01-09	DISSECTING SCISSORS, 12CM, STRAIGHT, MAGIC CUT
DDS-14-01-10	DISSECTING SCISSORS, 12CM, CURVED, MAGIC CUT



Item Code	Description
DS-13-33	RIBBON UTILITY SCISSORS, 9.5CM, CURVED



Item Code	Description
DDS-14-28-01	STEVENS SCISSORS, 13CM, CURVED
DDS-14-28-02	STEVENS SCISSORS, 13CM, CURVED, SUPERCUT
DDS-14-28-03	STEVENS SCISSORS, 13CM, CURVED, TC
DDS-14-28-04	STEVENS SCISSORS, 13CM, CURVED, SUPERCUT PLUS
DDS-14-28-05	STEVENS SCISSORS, 13CM, CURVED, MAGIC CUT



Delicate Dissecting Scissors



Item Code Description

DDS-14-35-01	GREENBERG PAR SCISSORS, 11.5CM, CURVED
DDS-14-35-02	GREENBERG PAR SCISSORS, 11.5CM, CURVED, SUPERCUT
DDS-14-35-03	GREENBERG PAR SCISSORS, 11.5CM, CURVED, TC
DDS-14-35-04	GREENBERG PAR SCISSORS, 11.5CM, CURVED, SUPERCUT PLUS
DDS-14-35-05	GREENBERG PAR SCISSORS, 11.5CM, CURVED, MAGIC CUT

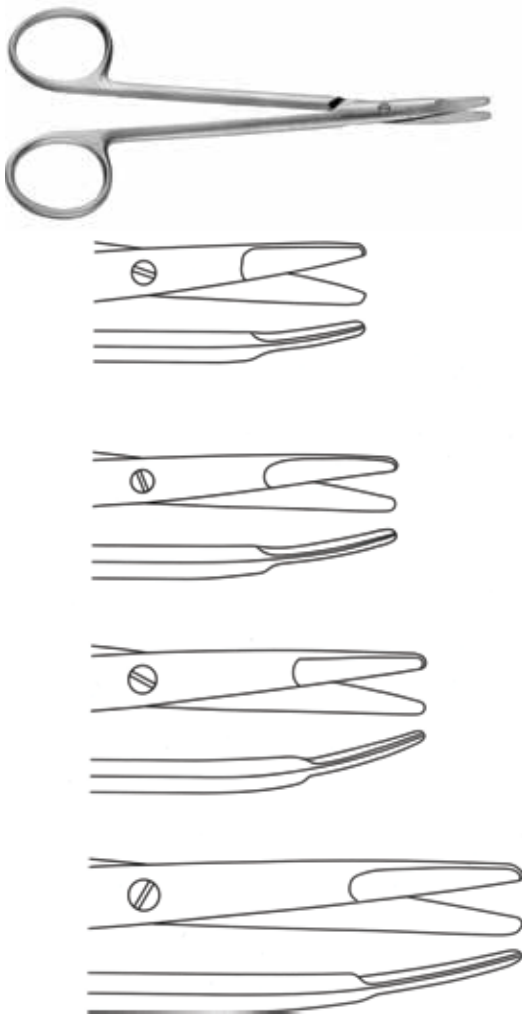

Item Code Description

DDS-14-36-01	RAGNELL KILNER SCISSORS, CURVED, 13CM
DDS-14-36-02	RAGNELL KILNER SCISSORS, CURVED, 15CM
DDS-14-36-03	RAGNELL KILNER SCISSORS, CURVED, 18CM
DDS-14-36-04	RAGNELL KILNER SCISSORS, CURVED, 20CM
DDS-14-36-05	RAGNELL KILNER SCISSORS, CURVED, 13CM, SUPERCUT
DDS-14-36-06	RAGNELL KILNER SCISSORS, CURVED, 15CM, SUPERCUT
DDS-14-36-07	RAGNELL KILNER SCISSORS, CURVED, 18CM, SUPERCUT
DDS-14-36-08	RAGNELL KILNER SCISSORS, CURVED, 20CM, SUPERCUT
DDS-14-36-09	RAGNELL KILNER SCISSORS, CURVED, 13CM, TC
DDS-14-36-10	RAGNELL KILNER SCISSORS, CURVED, 15CM, TC
DDS-14-36-11	RAGNELL KILNER SCISSORS, CURVED, 18CM, TC
DDS-14-36-12	RAGNELL KILNER SCISSORS, CURVED, 20CM, TC
DDS-14-36-13	RAGNELL KILNER SCISSORS, CURVED, 13CM, SUPERCUT PLUS
DDS-14-36-14	RAGNELL KILNER SCISSORS, CURVED, 15CM, SUPERCUT PLUS
DDS-14-36-15	RAGNELL KILNER SCISSORS, CURVED, 18CM, SUPERCUT PLUS
DDS-14-36-16	RAGNELL KILNER SCISSORS, CURVED, 20CM, SUPERCUT PLUS
DDS-14-36-17	RAGNELL KILNER SCISSORS, CURVED, 13CM, MAGIC CUT
DDS-14-36-18	RAGNELL KILNER SCISSORS, CURVED, 15CM, MAGIC CUT
DDS-14-36-19	RAGNELL KILNER SCISSORS, CURVED, 18CM, MAGIC CUT
DDS-14-36-20	RAGNELL KILNER SCISSORS, CURVED, 20CM, MAGIC CUT

ZIMAIZ
INTERNATIONAL

Delicate Dissecting Scissors



Item Code Description

DDS-14-43-01	PECK JOSEPH SCISSORS , 14CM, STRAIGHT, SHARP
DDS-14-43-02	PECK JOSEPH SCISSORS , 14CM, CURVED, SHARP
DDS-14-43-03	PECK JOSEPH SCISSORS , 14CM, STRAIGHT, BLUNT
DDS-14-43-04	PECK JOSEPH SCISSORS , 14CM, CURVED, BLUNT
DDS-14-43-05	PECK JOSEPH SCISSORS , 14CM, STRAIGHT, SHARP, SUPERCUT
DDS-14-43-06	PECK JOSEPH SCISSORS , 14CM, CURVED, SHARP, SUPERCUT
DDS-14-43-07	PECK JOSEPH SCISSORS , 14CM, STRAIGHT, BLUNT, SUPERCUT
DDS-14-43-08	PECK JOSEPH SCISSORS , 14CM, CURVED, BLUNT, SUPERCUT

INTERNATIONAL



Item Code Description

DDS-14-33-01	SIEGERT DISSECTING SCISSORS, 11.5CM, STRAIGHT
DDS-14-33-02	SIEGERT DISSECTING SCISSORS, 11.5CM, CURVED
DDS-14-33-03	SIEGERT DISSECTING SCISSORS, 11.5CM, STRAIGHT, SUPERCUT
DDS-14-33-04	SIEGERT DISSECTING SCISSORS, 11.5CM, CURVED, SUPERCUT
DDS-14-33-05	SIEGERT DISSECTING SCISSORS, 11.5CM, STRAIGHT, TC
DDS-14-33-06	SIEGERT DISSECTING SCISSORS, 11.5CM, CURVED, TC
DDS-14-33-07	SIEGERT DISSECTING SCISSORS, 11.5CM, STRAIGHT, SUPERCUT PLUS
DDS-14-33-08	SIEGERT DISSECTING SCISSORS, 11.5CM, CURVED, SUPERCUT PLUS
DDS-14-33-09	SIEGERT DISSECTING SCISSORS, 11.5CM, STRAIGHT, MAGIC CUT
DDS-14-33-10	SIEGERT DISSECTING SCISSORS, 11.5CM, CURVED, MAGIC CUT



Item Code Description

DDS-14-26-01	JOSEPH SCISSORS, 15CM, STRAIGHT
DDS-14-26-02	JOSEPH SCISSORS, 15CM, CURVED
DDS-14-26-03	JOSEPH SCISSORS, 15CM, STRAIGHT, SUPERCUT
DDS-14-26-04	JOSEPH SCISSORS, 15CM, CURVED, SUPERCUT



Delicate Dissecting Scissors



Item Code Description

DDS-14-14-01	SLIM DISSECTING SCISSORS, 14CM, STRAIGHT
DDS-14-14-02	SLIM DISSECTING SCISSORS, 18CM, STRAIGHT
DDS-14-14-03	SLIM DISSECTING SCISSORS, 20CM, STRAIGHT
DDS-14-14-07	SLIM DISSECTING SCISSORS, 14CM, STRAIGHT, SUPERCUT
DDS-14-14-08	SLIM DISSECTING SCISSORS, 18CM, STRAIGHT, SUPERCUT
DDS-14-14-09	SLIM DISSECTING SCISSORS, 20CM, STRAIGHT, SUPERCUT
DDS-14-14-13	SLIM DISSECTING SCISSORS, 14CM, STRAIGHT, TC
DDS-14-14-14	SLIM DISSECTING SCISSORS, 18CM, STRAIGHT, TC
DDS-14-14-15	SLIM DISSECTING SCISSORS, 20CM, STRAIGHT, TC
DDS-14-14-19	SLIM DISSECTING SCISSORS, 14CM, STRAIGHT, SUPERCUT PLUS
DDS-14-14-20	SLIM DISSECTING SCISSORS, 18CM, STRAIGHT, SUPERCUT PLUS
DDS-14-14-21	SLIM DISSECTING SCISSORS, 20CM, STRAIGHT, SUPERCUT PLUS



Item Code Description

DDS-14-14-04	SLIM DISSECTING SCISSORS, 14CM, CURVED
DDS-14-14-05	SLIM DISSECTING SCISSORS, 18CM, CURVED
DDS-14-14-06	SLIM DISSECTING SCISSORS, 20CM, CURVED
DDS-14-14-10	SLIM DISSECTING SCISSORS, 14CM, CURVED, SUPERCUT
DDS-14-14-11	SLIM DISSECTING SCISSORS, 18CM, CURVED, SUPERCUT
DDS-14-14-12	SLIM DISSECTING SCISSORS, 20CM, CURVED, SUPERCUT
DDS-14-14-16	SLIM DISSECTING SCISSORS, 14CM, CURVED, TC
DDS-14-14-17	SLIM DISSECTING SCISSORS, 18CM, CURVED, TC
DDS-14-14-18	SLIM DISSECTING SCISSORS, 20CM, CURVED, TC
DDS-14-14-22	SLIM DISSECTING SCISSORS, 14CM, CURVED, SUPERCUT PLUS
DDS-14-14-23	SLIM DISSECTING SCISSORS, 18CM, CURVED, SUPERCUT PLUS
DDS-14-14-24	SLIM DISSECTING SCISSORS, 20CM, CURVED, SUPERCUT PLUS

ZIMAIZ
INTERNATIONAL



Delicate Dissecting Scissors

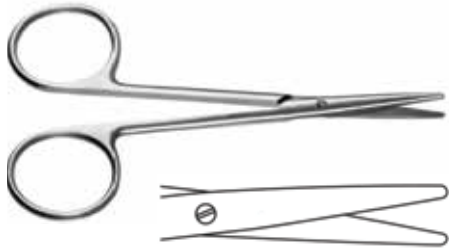

Item Code	Description
DDS-14-79-01	BABY METZENBAUM SCISSORS SUPERCUT, 11.5CM, X-LARGE RING HANDLES, STRAIGHT
DDS-14-79-02	BABY METZENBAUM SCISSORS SUPERCUT, 11.5CM, X-LARGE RING HANDLES, CURVED



Item Code	Description
DDS-14-85-01	STEVENS SCISSORS SUPERCUT, 12.5CM, X-LARGE RING HANDLES, STRAIGHT
DDS-14-85-02	STEVENS SCISSORS SUPERCUT, 12.5CM, X-LARGE RING HANDLES, CURVED



Item Code	Description
DDS-14-63-01	JAMESON SCISSORS, 15CM, STRAIGHT
DDS-14-63-02	JAMESON SCISSORS, 18CM, STRAIGHT
DDS-14-63-03	JAMESON SCISSORS, 15CM, CURVED
DDS-14-63-04	JAMESON SCISSORS, 18CM, CURVED
DDS-14-63-05	JAMESON SCISSORS, 15CM, STRAIGHT, SUPERCUT
DDS-14-63-06	JAMESON SCISSORS, 18CM, STRAIGHT, SUPERCUT
DDS-14-63-07	JAMESON SCISSORS, 15CM, CURVED, SUPERCUT
DDS-14-63-08	JAMESON SCISSORS, 18CM, CURVED, SUPERCUT

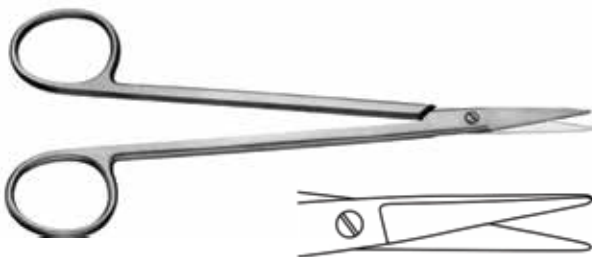

Item Code	Description
DDS-14-60-01	BRUSER KELLY SCISSORS SUPERCUT, 16CM, STRAIGHT
DDS-14-60-02	BRUSER KELLY SCISSORS SUPERCUT, 16CM, CURVED



Delicate Dissecting Scissors



Item Code Description

DDS-14-52-01 MINI METZENBAUM SCISSORS SUPERCUT, 9CM, STRAIGHT

DDS-14-52-02 MINI METZENBAUM SCISSORS SUPERCUT, 9CM, CURVED



Item Code Description

DDS-14-53-01 BABY METZENBAUM SCISSORS, 11.5CM

DDS-14-53-02 BABY METZENBAUM SCISSORS, 11.5CM, SUPERCUT

DDS-14-53-03 BABY METZENBAUM SCISSORS, 11.5CM, TC

DDS-14-53-04 BABY METZENBAUM SCISSORS, 11.5CM, SUPERCUT PLUS

DDS-14-53-05 BABY METZENBAUM SCISSORS, 11.5CM, MAGIC CUT

Dissecting Scissors



MAYO OPERATING SCISSORS

Item Code	Description
DS-15-01-01	14CM, STRAIGHT
DS-15-01-02	17CM, STRAIGHT
DS-15-01-03	14CM, CURVED
DS-15-01-04	17CM, CURVED
DS-15-01-05	14CM, STRAIGHT, SUPERCUT
DS-15-01-06	17CM, STRAIGHT, SUPERCUT
DS-15-01-07	14CM, CURVED, SUPERCUT
DS-15-01-08	17CM, CURVED, SUPERCUT
DS-15-01-09	14CM, STRAIGHT, TC
DS-15-01-10	17CM, STRAIGHT, TC
DS-15-01-11	14CM, CURVED, TC
DS-15-01-12	17CM, CURVED, TC
DS-15-01-13	14CM, STRAIGHT, SUPERCUT PLUS
DS-15-01-14	17CM, STRAIGHT, SUPERCUT PLUS
DS-15-01-15	14CM, CURVED, SUPERCUT PLUS
DS-15-01-16	17CM, CURVED, SUPERCUT PLUS



MAYO LEXER SCISSORS

Item Code	Description
DS-15-102-01	16.5CM, STRAIGHT
DS-15-102-02	16.5CM, CURVED
DS-15-102-03	16.5CM, STRAIGHT, SUPERCUT
DS-15-102-04	16.5CM, CURVED, SUPERCUT
DS-15-102-05	16.5CM, STRAIGHT, TC
DS-15-102-06	16.5CM, CURVED, TC
DS-15-102-07	16.5CM, STRAIGHT, SUPERCUT PLUS
DS-15-102-08	16.5CM, CURVED, SUPERCUT PLUS
DS-15-102-09	16.5CM, STRAIGHT, MAGIC CUT
DS-15-102-10	16.5CM, CURVED, MAGIC CUT



Dissecting Scissors



LEXER OPERATING SCISSORS

Item Code	Description
DS-15-09-01	16CM, STRAIGHT
DS-15-09-02	16CM, CURVED
DS-15-09-03	16CM, STRAIGHT, SUPERCUT
DS-15-09-04	16CM, CURVED, SUPERCUT
DS-15-09-05	16CM, STRAIGHT, TC
DS-15-09-06	16CM, CURVED, TC
DS-15-09-07	16CM, STRAIGHT, SUPERCUT PLUS
DS-15-09-08	16CM, CURVED, SUPERCUT PLUS
DS-15-09-09	16CM, STRAIGHT, MAGIC CUT
DS-15-09-10	16CM, CURVED, MAGIC CUT

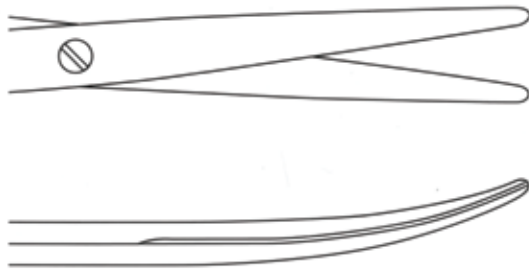

MAYO STILLE SCISSORS

Item Code	Description
DS-15-13-01	15CM, STRAIGHT
DS-15-13-02	17CM, STRAIGHT
DS-15-13-03	15CM, CURVED
DS-15-13-04	17CM, CURVED
DS-15-13-05	15CM, STRAIGHT, SUPERCUT
DS-15-13-06	17CM, STRAIGHT, SUPERCUT
DS-15-13-07	15CM, CURVED, SUPERCUT
DS-15-13-08	17CM, CURVED, SUPERCUT
DS-15-13-09	15CM, STRAIGHT, TC
DS-15-13-10	17CM, STRAIGHT, TC
DS-15-13-11	15CM, CURVED, TC
DS-15-13-12	17CM, CURVED, TC
DS-15-13-13	15CM, STRAIGHT, SUPERCUT PLUS
DS-15-13-14	17CM, STRAIGHT, SUPERCUT PLUS
DS-15-13-15	15CM, CURVED, SUPERCUT PLUS
DS-15-13-16	17CM, CURVED, SUPERCUT PLUS
DS-15-13-17	15CM, STRAIGHT, MAGIC CUT
DS-15-13-18	17CM, STRAIGHT, MAGIC CUT
DS-15-13-19	15CM, CURVED, MAGIC CUT
DS-15-13-20	17CM, CURVED, MAGIC CUT

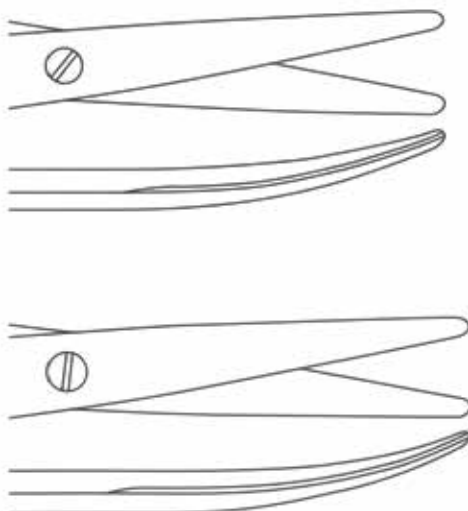

Dissecting Scissors



METZENBAUM SCISSORS

Item Code	Description
DS-15-18-01	14CM, STRAIGHT
DS-15-18-02	15CM, STRAIGHT
DS-15-18-03	18CM, STRAIGHT
DS-15-18-04	20CM, STRAIGHT
DS-15-18-05	14CM, CURVED
DS-15-18-06	15CM, CURVED
DS-15-18-07	18CM, CURVED
DS-15-18-08	20CM, CURVED
DS-15-18-09	14CM, STRAIGHT, SUPERCUT
DS-15-18-10	15CM, STRAIGHT, SUPERCUT
DS-15-18-11	18CM, STRAIGHT, SUPERCUT
DS-15-18-12	20CM, STRAIGHT, SUPERCUT
DS-15-18-13	14CM, CURVED, SUPERCUT
DS-15-18-14	15CM, CURVED, SUPERCUT
DS-15-18-15	18CM, CURVED, SUPERCUT
DS-15-18-16	20CM, CURVED, SUPERCUT
DS-15-18-17	14CM, STRAIGHT, TC
DS-15-18-18	15CM, STRAIGHT, TC
DS-15-18-19	18CM, STRAIGHT, TC
DS-15-18-20	20CM, STRAIGHT, TC
DS-15-18-21	14CM, CURVED, TC
DS-15-18-22	15CM, CURVED, TC
DS-15-18-23	18CM, CURVED, TC
DS-15-18-24	20CM, CURVED, TC
DS-15-18-25	14CM, STRAIGHT, SUPERCUT PLUS
DS-15-18-26	15CM, STRAIGHT, SUPERCUT PLUS
DS-15-18-27	18CM, STRAIGHT, SUPERCUT PLUS
DS-15-18-28	20CM, STRAIGHT, SUPERCUT PLUS
DS-15-18-29	14CM, CURVED, SUPERCUT PLUS
DS-15-18-30	14CM, CURVED, SUPERCUT PLUS.
DS-15-18-31	18CM, CURVED, SUPERCUT PLUS
DS-15-18-32	18CM, CURVED, SUPERCUT PLUS
DS-15-18-33	14CM, STRAIGHT, MAGIC CUT
DS-15-18-34	15CM, STRAIGHT, MAGIC CUT
DS-15-18-35	18CM, STRAIGHT, MAGIC CUT
DS-15-18-36	20CM, STRAIGHT, MAGIC CUT
DS-15-18-37	14CM, CURVED, MAGIC CUT
DS-15-18-38	15CM, CURVED, MAGIC CUT
DS-15-18-39	18CM, CURVED, MAGIC CUT
DS-15-18-40	20CM, CURVED, MAGIC CUT



Dissecting Scissors

METZENBAUM SCISSORS, 14CM, SHORT BLADES

Item Code	Description
DS-15-106-01	STRAIGHT
DS-15-106-02	CURVED
DS-15-106-03	STRAIGHT, SUPERCUT
DS-15-106-04	CURVED, SUPERCUT
DS-15-106-05	STRAIGHT, TC
DS-15-106-06	CURVED, TC
DS-15-106-07	STRAIGHT, SUPERCUT PLUS
DS-15-106-08	CURVED, SUPERCUT PLUS
DS-15-106-09	STRAIGHT, MAGIC CUT
DS-15-106-10	CURVED, MAGIC CUT

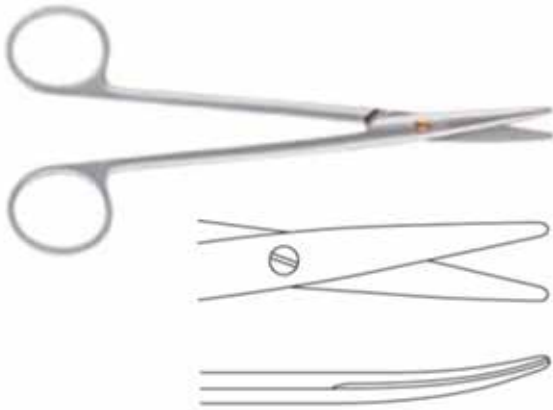

NELSON METZENBAUM SCISSORS

Item Code	Description
DS-15-26-01	23CM, STRAIGHT
DS-15-26-02	26CM, STRAIGHT
DS-15-26-03	30CM, STRAIGHT
DS-15-26-04	23CM, CURVED
DS-15-26-05	26CM, CURVED
DS-15-26-06	30CM, CURVED
DS-15-26-07	23CM, STRAIGHT, SUPERCUT
DS-15-26-08	26CM, STRAIGHT, SUPERCUT
DS-15-26-09	30CM, STRAIGHT, SUPERCUT
DS-15-26-10	23CM, CURVED, SUPERCUT
DS-15-26-11	26CM, CURVED, SUPERCUT
DS-15-26-12	30CM, CURVED, SUPERCUT
DS-15-26-13	23CM, STRAIGHT, TC
DS-15-26-14	26CM, STRAIGHT, TC
DS-15-26-15	30CM, STRAIGHT, TC
DS-15-26-16	23CM, CURVED, TC
DS-15-26-17	26CM, CURVED, TC
DS-15-26-18	30CM, CURVED, TC
DS-15-26-19	23CM, STRAIGHT, SUPERCUT PLUS
DS-15-26-20	26CM, STRAIGHT, SUPERCUT PLUS
DS-15-26-21	30CM, STRAIGHT, SUPERCUT PLUS
DS-15-26-22	23CM, CURVED, SUPERCUT PLUS
DS-15-26-23	26CM, CURVED, SUPERCUT PLUS
DS-15-26-24	30CM, CURVED, SUPERCUT PLUS
DS-15-26-25	23CM, STRAIGHT, MAGIC CUT
DS-15-26-26	26CM, STRAIGHT, MAGIC CUT
DS-15-26-27	30CM, STRAIGHT, MAGIC CUT
DS-15-26-28	23CM, CURVED, MAGIC CUT
DS-15-26-29	26CM, CURVED, MAGIC CUT
DS-15-26-30	30CM, CURVED, MAGIC CUT

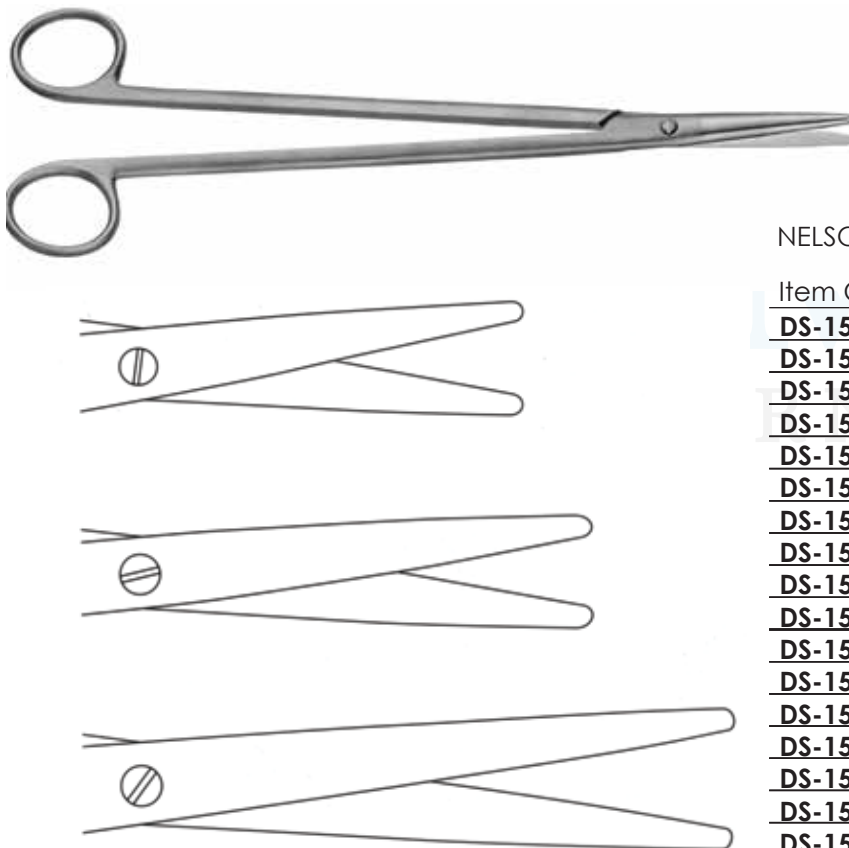

Dissecting Scissors



METZENBAUM SLIM SCISSORS

Item Code	Description
DS-15-45-01	14CM, STRAIGHT
DS-15-45-02	18CM, STRAIGHT
DS-15-45-03	20CM, STRAIGHT
DS-15-45-04	23CM, STRAIGHT
DS-15-45-05	14CM, CURVED
DS-15-45-06	18CM, CURVED
DS-15-45-07	20CM, CURVED
DS-15-45-08	23CM, CURVED
DS-15-45-09	14CM, STRAIGHT, SUPERCUT
DS-15-45-10	18CM, STRAIGHT, SUPERCUT
DS-15-45-11	20CM, STRAIGHT, SUPERCUT
DS-15-45-12	23CM, STRAIGHT, SUPERCUT
DS-15-45-13	14CM, CURVED, SUPERCUT
DS-15-45-14	18CM, CURVED, SUPERCUT
DS-15-45-15	20CM, CURVED, SUPERCUT
DS-15-45-16	23CM, CURVED, SUPERCUT
DS-15-45-17	14CM, STRAIGHT, TC
DS-15-45-18	18CM, STRAIGHT, TC
DS-15-45-19	20CM, STRAIGHT, TC
DS-15-45-20	23CM, STRAIGHT, TC
DS-15-45-21	14CM, CURVED, TC
DS-15-45-22	18CM, CURVED, TC
DS-15-45-23	20CM, CURVED, TC
DS-15-45-24	23CM, CURVED, TC
DS-15-45-25	14CM, STRAIGHT
DS-15-45-26	18CM, STRAIGHT
DS-15-45-27	20CM, STRAIGHT
DS-15-45-28	23CM, STRAIGHT
DS-15-45-29	14CM, CURVED
DS-15-45-30	18CM, CURVED
DS-15-45-31	20CM, CURVED
DS-15-45-32	23CM, CURVED
DS-15-45-33	14CM, STRAIGHT
DS-15-45-34	18CM, STRAIGHT
DS-15-45-35	20CM, STRAIGHT
DS-15-45-36	23CM, STRAIGHT
DS-15-45-37	14CM, CURVED
DS-15-45-38	18CM, CURVED
DS-15-45-39	20CM, CURVED
DS-15-45-40	23CM, CURVED



Dissecting Scissors

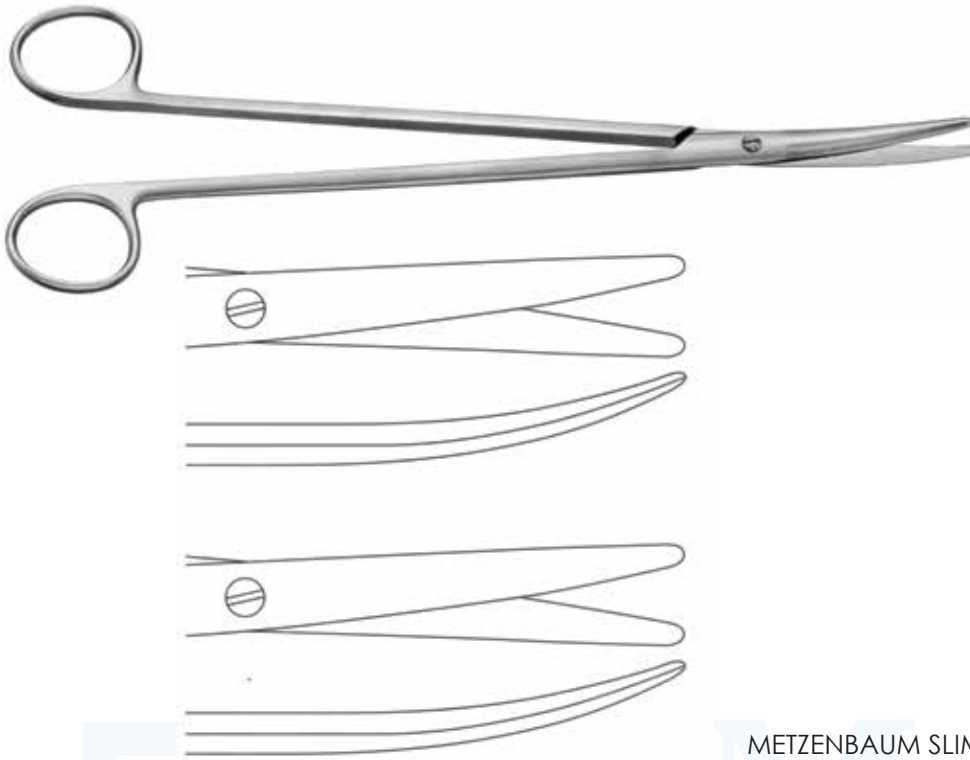

METZENBAUM SLIM SCISSORS SUPERCUT

Item Code	Description
DS-15-144-01	26CM, STRAIGHT
DS-15-144-02	28.5CM, STRAIGHT
DS-15-144-03	26CM, CURVED
DS-15-144-04	28.5CM, CURVED

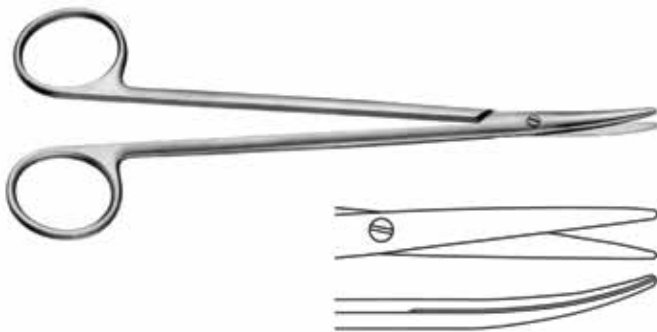

TOENNIS ADSON SCISSORS, 18CM

Item Code	Description
DS-15-68-01	STRAIGHT
DS-15-68-02	CURVED
DS-15-68-03	STRAIGHT, SUPERCUT
DS-15-68-04	CURVED, SUPERCUT
DS-15-68-05	STRAIGHT, TC
DS-15-68-06	CURVED, TC
DS-15-68-07	STRAIGHT, SUPERCUT PLUS
DS-15-68-08	CURVED, SUPERCUT PLUS
DS-15-68-09	STRAIGHT, MAGIC CUT
DS-15-68-10	CURVED, MAGIC CUT



Dissecting Scissors

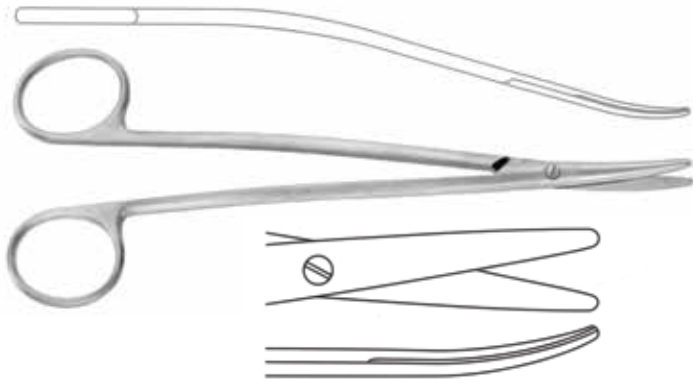

METZENBAUM SLIM SCISSORS, S-CURVED

Item Code	Description
DS-15-137-01	18CM
DS-15-137-02	20CM
DS-15-137-03	23CM
DS-15-137-04	18CM, SUPERCUT
DS-15-137-05	20CM, SUPERCUT
DS-15-137-06	23CM, SUPERCUT
DS-15-137-07	18CM, TC
DS-15-137-08	20CM, TC
DS-15-137-09	23CM, TC
DS-15-137-10	18CM, SUPERCUT PLUS
DS-15-137-11	20CM, SUPERCUT PLUS
DS-15-137-12	23CM, SUPERCUT PLUS

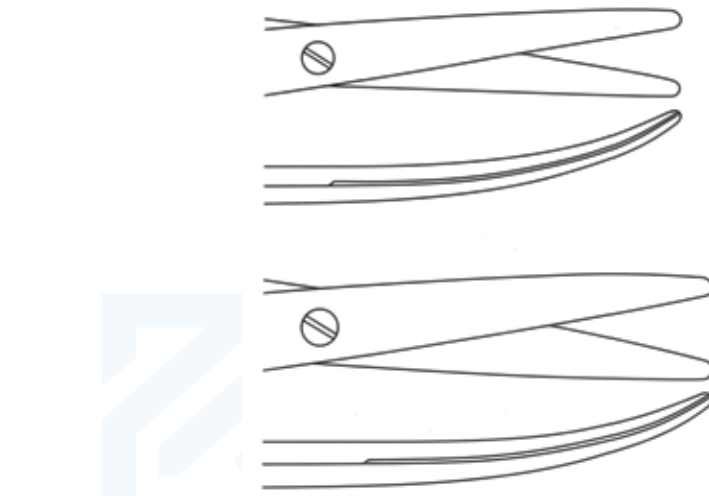

METZENBAUM FREEMAN SCISSORS

Item Code	Description
DS-15-157-01	18CM, STRAIGHT
DS-15-157-02	20CM, STRAIGHT
DS-15-157-03	23CM, STRAIGHT
DS-15-157-04	18CM, CURVED
DS-15-157-05	20CM, CURVED
DS-15-157-06	23CM, CURVED
DS-15-157-07	18CM, STRAIGHT, SUPERCUT
DS-15-157-08	20CM, STRAIGHT, SUPERCUT
DS-15-157-09	23CM, STRAIGHT, SUPERCUT
DS-15-157-10	18CM, CURVED, SUPERCUT
DS-15-157-11	20CM, CURVED, SUPERCUT
DS-15-157-12	23CM, CURVED, SUPERCUT

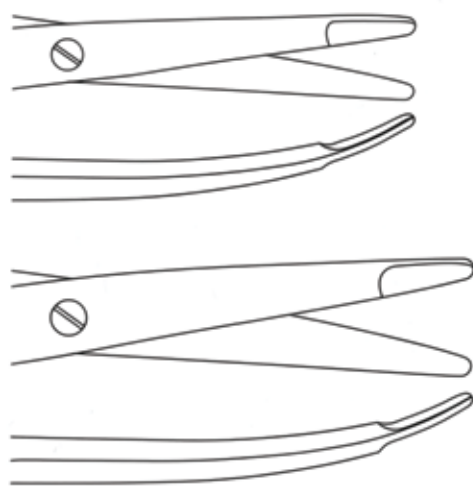



Dissecting Scissors

KELLY SCISSORS, 16CM

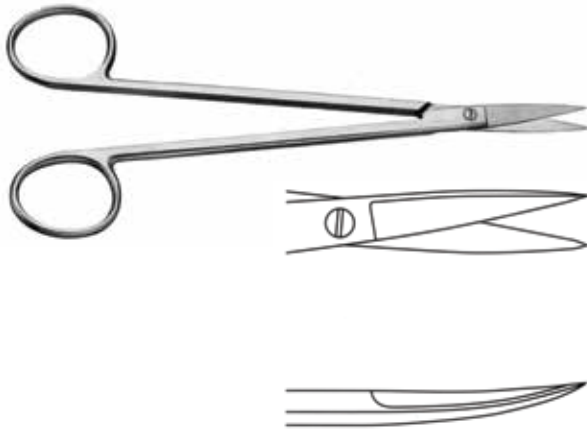

Item Code	Description
DS-15-64-01	STRAIGHT
DS-15-64-02	CURVED
DS-15-64-03	STRAIGHT, SUPERCUT
DS-15-64-04	CURVED, SUPERCUT
DS-15-64-05	STRAIGHT, TC
DS-15-64-06	CURVED, TC
DS-15-64-07	STRAIGHT, SUPERCUT PLUS
DS-15-64-08	CURVED, SUPERCUT PLUS
DS-15-64-09	STRAIGHT, MAGIC CUT
DS-15-64-10	CURVED, MAGIC CUT

REYNOLDS JAMESON SCISSORS

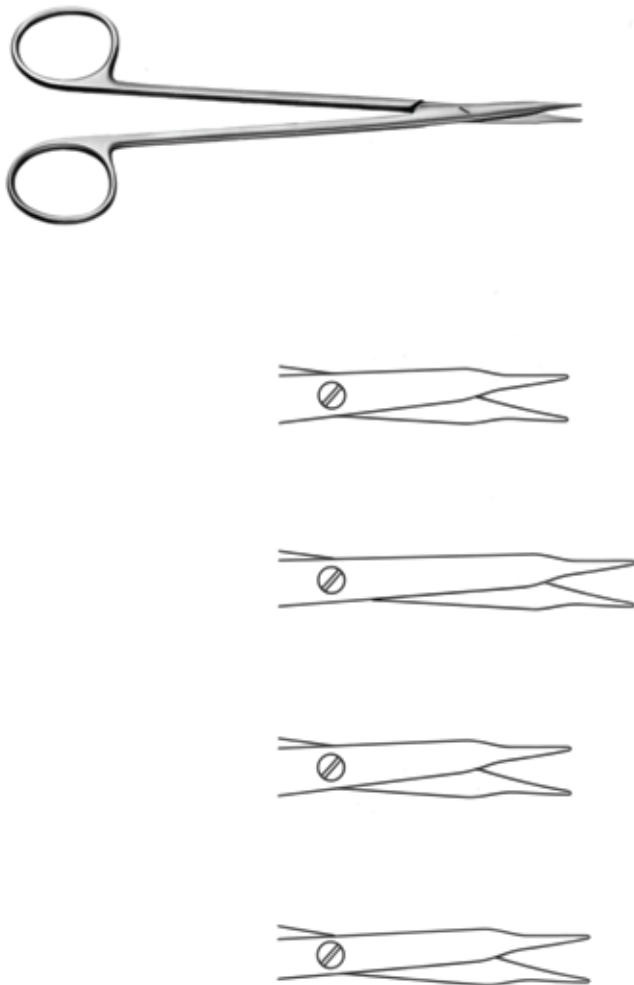

Item Code	Description
DS-15-70-01	12CM, STRAIGHT
DS-15-70-02	14CM, STRAIGHT
DS-15-70-03	16CM, STRAIGHT
DS-15-70-04	18CM, STRAIGHT
DS-15-70-05	12CM, CURVED
DS-15-70-06	14CM, CURVED
DS-15-70-07	16CM, CURVED
DS-15-70-08	18CM, CURVED
DS-15-70-09	12CM, STRAIGHT, SUPERCUT
DS-15-70-10	14CM, STRAIGHT, SUPERCUT
DS-15-70-11	16CM, STRAIGHT, SUPERCUT
DS-15-70-12	18CM, STRAIGHT, SUPERCUT
DS-15-70-13	12CM, CURVED, SUPERCUT
DS-15-70-14	14CM, CURVED, SUPERCUT
DS-15-70-15	16CM, CURVED, SUPERCUT
DS-15-70-16	18CM, CURVED, SUPERCUT
DS-15-70-17	12CM, STRAIGHT, TC
DS-15-70-18	14CM, STRAIGHT, TC
DS-15-70-19	16CM, STRAIGHT, TC
DS-15-70-20	18CM, STRAIGHT, TC
DS-15-70-21	12CM, CURVED, TC
DS-15-70-22	14CM, CURVED, TC
DS-15-70-23	16CM, CURVED, TC
DS-15-70-24	18CM, CURVED, TC
DS-15-70-25	12CM, STRAIGHT, SUPERCUT PLUS
DS-15-70-26	14CM, STRAIGHT, SUPERCUT PLUS
DS-15-70-27	16CM, STRAIGHT, SUPERCUT PLUS
DS-15-70-28	18CM, STRAIGHT, SUPERCUT PLUS
DS-15-70-29	12CM, CURVED, SUPERCUT PLUS
DS-15-70-30	14CM, CURVED, SUPERCUT PLUS
DS-15-70-31	16CM, CURVED, SUPERCUT PLUS
DS-15-70-32	18CM, CURVED, SUPERCUT PLUS
DS-15-70-33	12CM, STRAIGHT, MAGIC CUT
DS-15-70-34	14CM, STRAIGHT, MAGIC CUT
DS-15-70-35	16CM, STRAIGHT, MAGIC CUT
DS-15-70-36	18CM, STRAIGHT, MAGIC CUT
DS-15-70-37	12CM, CURVED, MAGIC CUT
DS-15-70-38	14CM, CURVED, MAGIC CUT
DS-15-70-39	16CM, CURVED, MAGIC CUT
DS-15-70-40	18CM, CURVED, MAGIC CUT

Dissecting Scissors



FANOUS DISSECTING SCISSORS

Item Code	Description
DS-15-169-01	16.5CM, STRAIGHT
DS-15-169-02	20.5CM, STRAIGHT
DS-15-169-03	16.5CM, CURVED
DS-15-169-04	20.5CM, CURVED
DS-15-169-05	16.5CM, STRAIGHT, SUPERCUT
DS-15-169-06	20.5CM, STRAIGHT, SUPERCUT
DS-15-169-07	16.5CM, CURVED, SUPERCUT
DS-15-169-08	20.5CM, CURVED, SUPERCUT



ZIMAIZ
INTERNATIONAL



GORNEY SCISSORS

Item Code	Description
DS-15-173-01	CURVED, 17CM
DS-15-173-02	CURVED, 19CM
DS-15-173-03	CURVED, 23CM
DS-15-173-04	CURVED, 17CM, SUPERCUT
DS-15-173-05	CURVED, 19CM, SUPERCUT
DS-15-173-06	CURVED, 23CM, SUPERCUT
DS-15-173-07	CURVED, 17CM, TC
DS-15-173-08	CURVED, 19CM, TC
DS-15-173-09	CURVED, 23CM, TC
DS-15-173-10	CURVED, 17CM, SUPERCUT PLUS
DS-15-173-11	CURVED, 19CM, SUPERCUT PLUS
DS-15-173-12	CURVED, 23CM, SUPERCUT PLUS
DS-15-173-13	CURVED, 17CM, MAGIC CUT
DS-15-173-14	CURVED, 19CM, MAGIC CUT
DS-15-173-15	CURVED, 23CM, MAGIC CUT



Dissecting Scissors

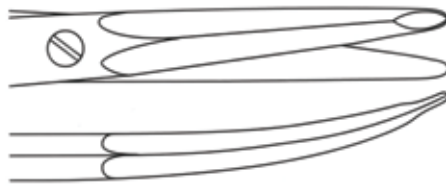
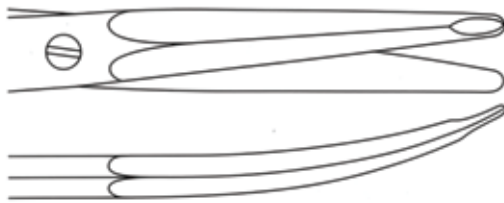
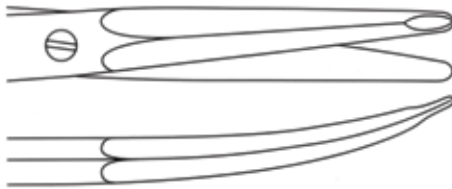
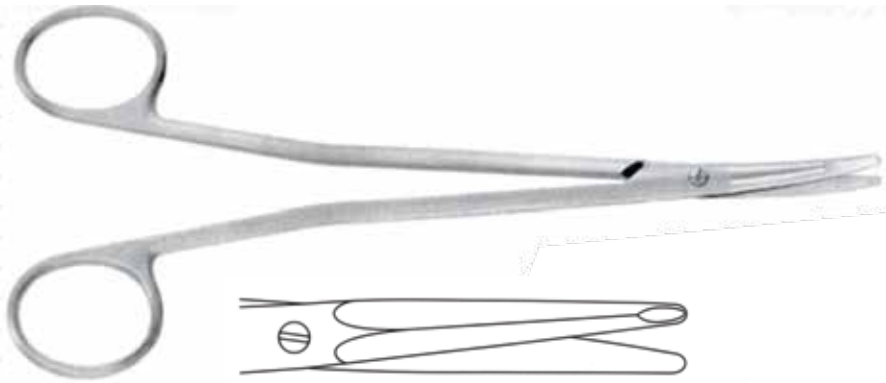

GORNEY FREEMAN SCISSORS

Item Code	Description
DS-15-176-01	CURVED, 17CM
DS-15-176-02	CURVED, 19CM
DS-15-176-03	CURVED, 23CM
DS-15-176-04	CURVED, 17CM, SUPERCUT
DS-15-176-05	CURVED, 19CM, SUPERCUT
DS-15-176-06	CURVED, 23CM, SUPERCUT
DS-15-176-07	CURVED, 17CM, TC
DS-15-176-08	CURVED, 19CM, TC
DS-15-176-09	CURVED, 23CM, TC
DS-15-176-10	CURVED, 17CM, SUPERCUT PLUS
DS-15-176-11	CURVED, 19CM, SUPERCUT PLUS
DS-15-176-12	CURVED, 23CM, SUPERCUT PLUS
DS-15-176-13	CURVED, 17CM, MAGIC CUT
DS-15-176-14	CURVED, 19CM, MAGIC CUT
DS-15-176-15	CURVED, 23CM, MAGIC CUT

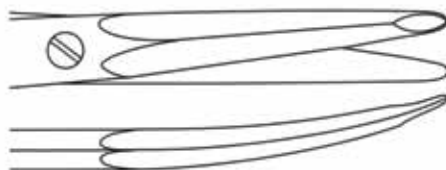
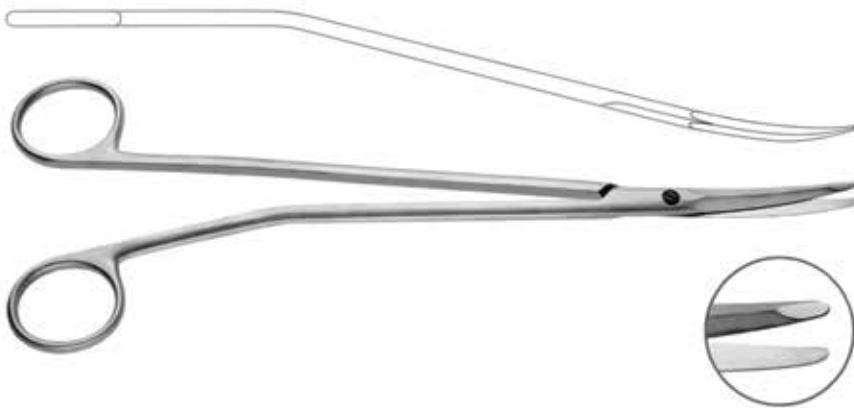

GORNEY FREEMAN SCISSORS, 23CM

Item Code	Description
DS-15-178-01	S CURVED
DS-15-178-02	S CURVED, SUPERCUT
DS-15-178-03	S CURVED, TC
DS-15-178-04	S CURVED, SUPERCUT PLUS
DS-15-178-05	S CURVED, MAGIC CUT

Dissecting Scissors

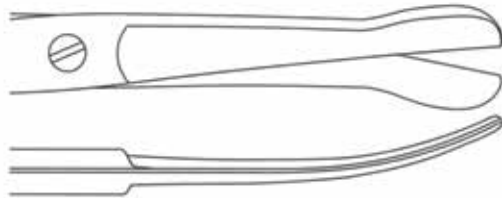

Item Code	Description
DS-15-185	SOLZ "GOLD TIP" SUPERCUT SCISSORS, 20CM, CURVED, SLIGHT BEVEL ON SHANK

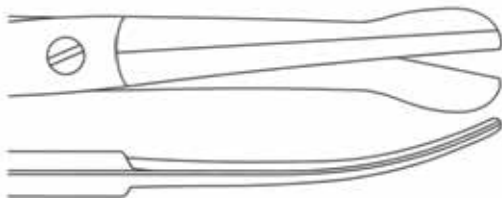

Item Code	Description
DS-15-242	SOLZ "GOLD TIP" SUPERCUT SCISSORS, 20CM, CURVED, STRONG BEVEL ON SHANK



Dissecting Scissors

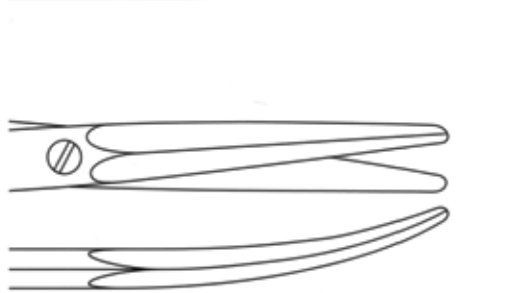
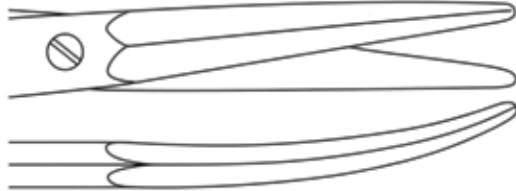

KAYE SCISSORS

Item Code	Description
DS-15-180-01	12.5CM, STRAIGHT
DS-15-180-02	15CM, STRAIGHT
DS-15-180-03	17CM, STRAIGHT
DS-15-180-04	19CM, STRAIGHT
DS-15-180-05	23CM, STRAIGHT
DS-15-180-06	12.5CM, CURVED
DS-15-180-07	15CM, CURVED
DS-15-180-08	17CM, CURVED
DS-15-180-09	19CM, CURVED
DS-15-180-10	23CM, CURVED
DS-15-180-11	12.5CM, STRAIGHT, SUPERCUT
DS-15-180-12	15CM, STRAIGHT, SUPERCUT
DS-15-180-13	17CM, STRAIGHT, SUPERCUT
DS-15-180-14	19CM, STRAIGHT, SUPERCUT
DS-15-180-15	23CM, STRAIGHT, SUPERCUT
DS-15-180-16	12.5CM, CURVED, SUPERCUT
DS-15-180-17	15CM, CURVED, SUPERCUT
DS-15-180-18	17CM, CURVED, SUPERCUT
DS-15-180-19	19CM, CURVED, SUPERCUT
DS-15-180-20	23CM, CURVED, SUPERCUT
DS-15-180-21	12.5CM, STRAIGHT, TC
DS-15-180-22	15CM, STRAIGHT, TC
DS-15-180-23	17CM, STRAIGHT, TC
DS-15-180-24	19CM, STRAIGHT, TC
DS-15-180-25	23CM, STRAIGHT, TC
DS-15-180-26	12.5CM, CURVED, TC
DS-15-180-27	15CM, CURVED, TC
DS-15-180-28	17CM, CURVED, TC
DS-15-180-29	19CM, CURVED, TC
DS-15-180-30	23CM, CURVED, TC
DS-15-180-31	12.5CM, STRAIGHT, SUPERCUT PLUS
DS-15-180-32	15CM, STRAIGHT, SUPERCUT PLUS
DS-15-180-33	17CM, STRAIGHT, SUPERCUT PLUS
DS-15-180-34	19CM, STRAIGHT, SUPERCUT PLUS
DS-15-180-35	23CM, STRAIGHT, SUPERCUT PLUS
DS-15-180-36	12.5CM, CURVED, SUPERCUT PLUS
DS-15-180-37	15CM, CURVED, SUPERCUT PLUS
DS-15-180-38	17CM, CURVED, SUPERCUT PLUS
DS-15-180-39	19CM, CURVED, SUPERCUT PLUS
DS-15-180-40	23CM, CURVED, SUPERCUT PLUS
DS-15-180-41	12.5CM, STRAIGHT, MAGIC CUT
DS-15-180-42	15CM, STRAIGHT, MAGIC CUT
DS-15-180-43	17CM, STRAIGHT, MAGIC CUT
DS-15-180-44	19CM, STRAIGHT, MAGIC CUT
DS-15-180-45	23CM, STRAIGHT, MAGIC CUT
DS-15-180-46	12.5CM, CURVED, MAGIC CUT
DS-15-180-47	15CM, CURVED, MAGIC CUT
DS-15-180-48	17CM, CURVED, MAGIC CUT
DS-15-180-49	19CM, CURVED, MAGIC CUT
DS-15-180-50	23CM, CURVED, MAGIC CUT

Gum Scissors

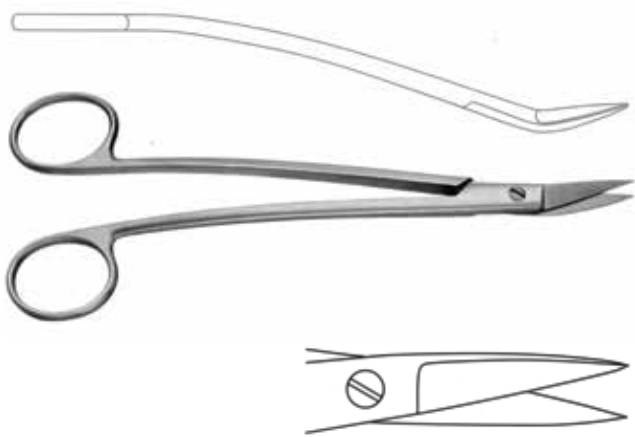

Item Code	Description
GS-16-11-01	DEAN SCISSORS, 17CM
GS-16-11-02	DEAN SCISSORS, 17CM, SUPERCUT



FOX GUM AND TISSUE SCISSORS, 13CM

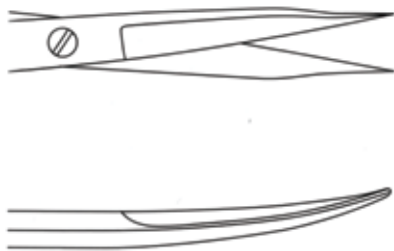

Item Code	Description
GS-16-01-01	STRAIGHT
GS-16-01-02	CURVED
GS-16-01-03	STRAIGHT, SUPERCUT
GS-16-01-04	CURVED, SUPERCUT
GS-16-01-05	STRAIGHT, TC
GS-16-01-06	CURVED, TC
GS-16-01-07	STRAIGHT, SUPERCUT PLUS
GS-16-01-08	CURVED, SUPERCUT PLUS



GOLDMAN FOX SCISSORS TC, 13 CM

Item Code	Description
GS-16-16-01	STRAIGHT
GS-16-16-02	CURVED



Ligature and Stitch Scissors

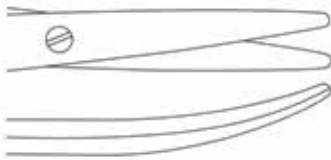

LIGATURE SCISSORS, CURVED SUPERCUT PLUS

Item Code	Description
LSS-17-08-01	14.5CM
LSS-17-08-02	18CM
LSS-17-08-03	23CM

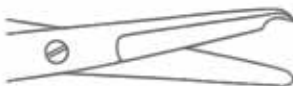

Item Code	Description
LSS-17-01-01	SPENCER STITCH SCISSORS, 9CM
LSS-17-01-02	SPENCER STITCH SCISSORS, 10.5CM
LSS-17-01-03	SPENCER STITCH SCISSORS, 12CM

Ligature and Stitch Scissors

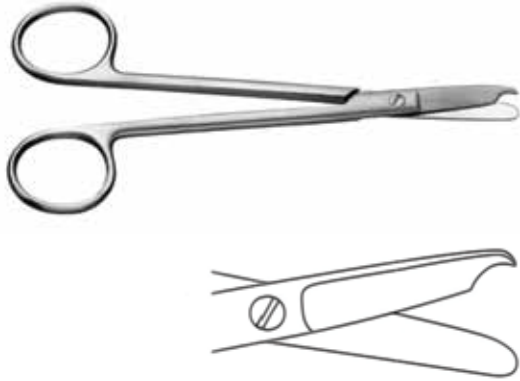

Item Code	Description
LSS-17-04	LITTAUER STITCH SCISSORS, 13CM

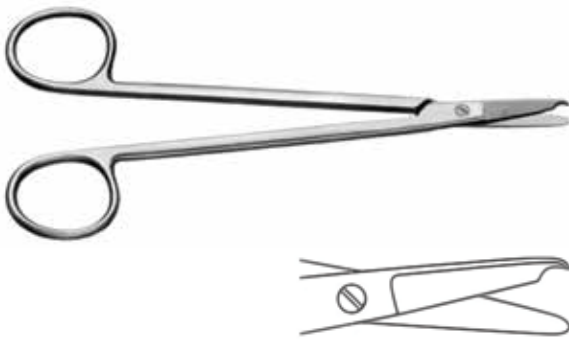

Item Code	Description
LSS-17-05	KELLY STITCH SCISSORS, 15CM



Item Code	Description
LSS-17-11	O'BRIEN STITCH SCISSORS, 9CM, ANGLED TO SIDE



Micro Scissors



MICRO 2000 SCISSORS, 15CM

Item Code	Description
MS-18-01-01	STRAIGHT
MS-18-01-02	CURVED
MS-18-01-03	STRAIGHT, SUPERCUT
MS-18-01-04	CURVED, SUPERCUT



serrated cutting edges



MICRO 2000 SCISSORS, 15CM

Item Code	Description
MS-18-03-01	SERRATED BLADES, STRAIGHT
MS-18-03-02	SERRATED BLADES, CURVED
MS-18-05-01	15CM, STRAIGHT
MS-18-05-02	15CM, CURVED



Vannas-type cutting edges



MICRO 2000 SCISSORS, 15CM

Item Code	Description
MS-18-11-01	9MM BLADES, STRAIGHT
MS-18-11-02	9MM BLADES, STRAIGHT
MS-18-11-03	9MM BLADES, STRAIGHT, SUPERCUT
MS-18-11-04	9MM BLADES, CURVED, SUPERCUT



Vannas-type cutting edges



MICRO 2000 SCISSORS, 15CM

Item Code	Description
MS-18-13-01	7MM BLADES, STRAIGHT
MS-18-13-02	7MM BLADES, CURVED

Micro Scissors



JACOBSON MICRO 2000 SCISSORS

Item Code	Description
MS-18-21-01	12MM BLADES, STRAIGHT
MS-18-21-02	12MM BLADES, CURVED



MICRO SCISSORS

Item Code	Description
MS-18-35	23CM, STRAIGHT, 10MM BLADES, STRAIGHT



Spiral Three Port Harvester Cannula



with Luer Lock Connector

Item Code	Size	Diameter
LC-01-01-L1	10 cm	1.5 mm
LC-01-01-L2	15 cm	1.5 mm
LC-01-01-L3	20 cm	1.5 mm
LC-01-01-L4	25 cm	1.5 mm

LC-01-01-L5	10 cm	2.0 mm
LC-01-01-L6	15 cm	2.0 mm
LC-01-01-L7	20 cm	2.0 mm
LC-01-01-L8	25 cm	2.0 mm

LC-01-01-L9	10 cm	2.5 mm
LC-01-01-L10	15 cm	2.5 mm
LC-01-01-L11	20 cm	2.5 mm
LC-01-01-L12	25 cm	2.5 mm

LC-01-01-L13	10 cm	3.0 mm
LC-01-01-L14	15 cm	3.0 mm
LC-01-01-L15	20 cm	3.0 mm
LC-01-01-L16	25 cm	3.0 mm



with Special Luer Lock Connector

Item Code	Size	Diameter
LC-01-01-S1	10 cm	1.5 mm
LC-01-01-S2	15 cm	1.5 mm
LC-01-01-S3	20 cm	1.5 mm
LC-01-01-S4	25 cm	1.5 mm

LC-01-01-S5	10 cm	2.0 mm
LC-01-01-S6	15 cm	2.0 mm
LC-01-01-S7	20 cm	2.0 mm
LC-01-01-S8	25 cm	2.0 mm

Item Code	Size	Diameter
LC-01-01-S9	10 cm	2.5 mm
LC-01-01-S10	15 cm	2.5 mm
LC-01-01-S11	20 cm	2.5 mm
LC-01-01-S12	25 cm	2.5 mm

LC-01-01-S13	10 cm	3.0 mm
LC-01-01-S14	15 cm	3.0 mm
LC-01-01-S15	20 cm	3.0 mm
LC-01-01-S16	25 cm	3.0 mm



with Super Handle

Item Code	Size	Diameter
LC-02-01-SH1	15 cm	2.5 mm
LC-02-01-SH2	20 cm	2.5 mm
LC-02-01-SH3	25 cm	2.5 mm
LC-02-01-SH4	30 cm	2.5 mm
LC-02-01-SH5	35 cm	2.5 mm

LC-02-01-SH6	15 cm	3.0 mm
LC-02-01-SH7	20 cm	3.0 mm
LC-02-01-SH8	25 cm	3.0 mm
LC-02-01-SH9	30 cm	3.0 mm
LC-02-01-SH10	35 cm	3.0 mm

LC-02-01-SH11	15 cm	4.0 mm
LC-02-01-SH12	20 cm	4.0 mm
LC-02-01-SH13	25 cm	4.0 mm
LC-02-01-SH14	30 cm	4.0 mm
LC-02-01-SH15	35 cm	4.0 mm

LC-02-01-SH11	15 cm	5.0 mm
LC-02-01-SH12	20 cm	5.0 mm
LC-02-01-SH13	25 cm	5.0 mm
LC-02-01-SH14	30 cm	5.0 mm
LC-02-01-SH15	35 cm	5.0 mm

Liposuction Cannulas



with Threaded Fitting

Item Code	Size	Diameter
LC-03-01-T1	15 cm	2.5 mm
LC-03-01-T2	20 cm	2.5 mm
LC-03-01-T3	25 cm	2.5 mm
LC-03-01-T4	30 cm	2.5 mm
LC-03-01-T5	35 cm	2.5 mm
<hr/>		
LC-03-01-T6	15 cm	3.0 mm
LC-03-01-T7	20 cm	3.0 mm
LC-03-01-T8	25 cm	3.0 mm
LC-03-01-T9	30 cm	3.0 mm
LC-03-01-T10	35 cm	3.0 mm
<hr/>		
LC-03-01-T11	15 cm	4.0 mm
LC-03-01-T12	20 cm	4.0 mm
LC-03-01-T13	25 cm	4.0 mm
LC-03-01-T14	30 cm	4.0 mm
LC-03-01-T15	35 cm	4.0 mm
<hr/>		
LC-03-01-T11	15 cm	5.0 mm
LC-03-01-T12	20 cm	5.0 mm
LC-03-01-T13	25 cm	5.0 mm
LC-03-01-T14	30 cm	5.0 mm
LC-03-01-T15	35 cm	5.0 mm



with Mini Threaded Fitting

Item Code	Size	Diameter
LC-03-01-MT1	15 cm	2.5 mm
LC-03-01-MT2	20 cm	2.5 mm
LC-03-01-MT3	25 cm	2.5 mm
LC-03-01-MT4	30 cm	2.5 mm
LC-03-01-MT5	35 cm	2.5 mm
<hr/>		
LC-03-01-MT6	15 cm	3.0 mm
LC-03-01-MT7	20 cm	3.0 mm
LC-03-01-MT8	25 cm	3.0 mm
LC-03-01-MT9	30 cm	3.0 mm
LC-03-01-MT10	35 cm	3.0 mm
<hr/>		
LC-03-01-MT11	15 cm	4.0 mm
LC-03-01-MT12	20 cm	4.0 mm
LC-03-01-MT13	25 cm	4.0 mm
LC-03-01-MT14	30 cm	4.0 mm
LC-03-01-MT15	35 cm	4.0 mm
<hr/>		
LC-03-01-MT11	15 cm	5.0 mm
LC-03-01-MT12	20 cm	5.0 mm
LC-03-01-MT13	25 cm	5.0 mm
LC-03-01-MT14	30 cm	5.0 mm
LC-03-01-MT15	35 cm	5.0 mm



Liposuction Cannulas

Six Port Spiral Harvester Cannula



with Luer Lock Connector

Item Code	Size	Diameter
LC-01-02-L1	15 cm	2.5 mm
LC-01-02-L2	25 cm	2.5 mm
LC-01-02-L3	15 cm	3.0 mm
LC-01-02-L4	25 cm	3.0 mm



with Special Luer Lock Connector

Item Code	Size	Diameter
LC-01-02-S1	15 cm	2.5 mm
LC-01-02-S2	25 cm	2.5 mm
LC-01-02-S3	15 cm	3.0 mm
LC-01-02-S4	25 cm	3.0 mm



with Super Handle

Item Code	Size	Diameter
LC-02-02-SH1	15 cm	2.5 mm
LC-02-02-SH2	20 cm	2.5 mm
LC-02-02-SH3	25 cm	2.5 mm
LC-02-02-SH4	15 cm	3.0 mm
LC-02-02-SH5	20 cm	3.0 mm
LC-02-02-SH6	25 cm	3.0 mm

LC-02-02-SH7	15 cm	3.5 mm
LC-02-02-SH8	20 cm	3.5 mm
LC-02-02-SH9	25 cm	3.5 mm

LC-02-02-SH10	15 cm	4.0 mm
LC-02-02-SH11	20 cm	4.0 mm
LC-02-02-SH12	25 cm	4.0 mm



with Threaded Fitting

Item Code	Size	Diameter
LC-03-02-T1	15 cm	2.5 mm
LC-03-02-T2	20 cm	2.5 mm
LC-03-02-T3	25 cm	2.5 mm

LC-03-02-T4	15 cm	3.0 mm
LC-03-02-T5	20 cm	3.0 mm
LC-03-02-T6	25 cm	3.0 mm

LC-03-02-T7	15 cm	3.5 mm
LC-03-02-T8	20 cm	3.5 mm
LC-03-02-T9	25 cm	3.5 mm

Liposuction Cannulas



Item Code	Size	Diameter
LC-03-02-T10	15 cm	4.0 mm
LC-03-02-T11	20 cm	4.0 mm
LC-03-02-T12	25 cm	4.0 mm



with Mini Threaded Fitting

Item Code	Size	Diameter
LC-03-02-MT1	15 cm	2.5 mm
LC-03-02-MT2	20 cm	2.5 mm
LC-03-02-MT3	25 cm	2.5 mm

LC-03-02-MT4	15 cm	3.0 mm
LC-03-02-MT5	20 cm	3.0 mm
LC-03-02-MT6	25 cm	3.0 mm

LC-03-02-MT7	15 cm	3.5 mm
LC-03-02-MT8	20 cm	3.5 mm
LC-03-02-MT9	25 cm	3.5 mm

LC-03-02-MT10	15 cm	4.0 mm
LC-03-02-MT11	20 cm	4.0 mm
LC-03-02-MT12	25 cm	4.0 mm



Multi Holes Harvester Cannula, Model 1



with Luer Lock Connector

Item Code	Size	Diameter
LC-01-03-L1	20 cm	2.5 mm
LC-01-03-L2	25 cm	2.5 mm

LC-01-03-L3	20 cm	3.0 mm
LC-01-03-L4	25 cm	3.0 mm



with Special Luer Lock Connector

Item Code	Size	Diameter
LC-01-03-S1	20 cm	2.5 mm
LC-01-03-S2	25 cm	2.5 mm

LC-01-03-S3	20 cm	3.0 mm
LC-01-03-S4	25 cm	3.0 mm



with Super Handle

Item Code	Size	Diameter
LC-02-03-SH1	20 cm	2.5 mm
LC-02-03-SH2	25 cm	2.5 mm

LC-02-03-SH3	20 cm	3.0 mm
LC-02-03-SH4	25 cm	3.0 mm



with Threaded Fitting

Item Code	Size	Diameter
LC-03-03-T1	20 cm	2.5 mm
LC-03-03-T2	25 cm	2.5 mm

LC-03-03-T3	20 cm	3.0 mm
LC-03-03-T4	25 cm	3.0 mm



with Mini Threaded Fitting

Item Code	Size	Diameter
LC-03-03-MT1	20 cm	2.5 mm
LC-03-03-MT2	25 cm	2.5 mm

LC-03-03-MT3	20 cm	3.0 mm
LC-03-03-MT4	25 cm	3.0 mm

Liposuction Cannulas



Multi Holes Harvester Cannula, Model 2



with Luer Lock Connector

Item Code	Size	Diameter
LC-01-04-L1	15 cm	2.5 mm
LC-01-04-L2	20 cm	2.5 mm
LC-01-04-L3	25 cm	2.5 mm

LC-01-04-L4	15 cm	3.0 mm
LC-01-04-L5	20 cm	3.0 mm
LC-01-04-L6	25 cm	3.0 mm



with Special Luer Lock Connector

Item Code	Size	Diameter
LC-01-04-S1	15 cm	2.5 mm
LC-01-04-S2	20 cm	2.5 mm
LC-01-04-S3	25 cm	2.5 mm

LC-01-04-S4	15 cm	3.0 mm
LC-01-04-S5	20 cm	3.0 mm
LC-01-04-S6	25 cm	3.0 mm



with Super Handle

Item Code	Size	Diameter
LC-02-04-SH1	15 cm	2.5 mm
LC-02-04-SH2	20 cm	2.5 mm
LC-02-04-SH3	25 cm	2.5 mm

Item Code	Size	Diameter
LC-02-04-SH4	15 cm	3.0 mm
LC-02-04-SH5	20 cm	3.0 mm
LC-02-04-SH6	25 cm	3.0 mm



with Threaded Fitting

Item Code	Size	Diameter
LC-03-04-T1	15 cm	2.5 mm
LC-03-04-T2	20 cm	2.5 mm
LC-03-04-T3	25 cm	2.5 mm

LC-03-04-T4	15 cm	3.0 mm
LC-03-04-T5	20 cm	3.0 mm
LC-03-04-T6	25 cm	3.0 mm



with Mini Threaded Fitting

Item Code	Size	Diameter
LC-03-04-MT1	15 cm	2.5 mm
LC-03-04-MT2	20 cm	2.5 mm
LC-03-04-MT3	25 cm	2.5 mm

LC-03-04-MT4	15 cm	3.0 mm
LC-03-04-MT5	20 cm	3.0 mm
LC-03-04-MT6	25 cm	3.0 mm



Multi Holes Harvester Cannula, Model 3



with Luer Lock Connector



with Super Handle

Item Code	Size	Diameter
LC-01-05-L1	15 cm	2.0 mm
LC-01-05-L2	20 cm	2.0 mm
LC-01-05-L3	25 cm	2.0 mm

LC-01-05-L4	15 cm	2.5 mm
LC-01-05-L5	20 cm	2.5 mm
LC-01-05-L6	25 cm	2.5 mm

LC-01-05-L7	15 cm	3.0 mm
LC-01-05-L8	20 cm	3.0 mm
LC-01-05-L9	25 cm	3.0 mm



with Special Luer Lock Connector

Item Code	Size	Diameter
LC-01-05-S1	15 cm	2.0 mm
LC-01-05-S2	20 cm	2.0 mm
LC-01-05-S3	25 cm	2.0 mm

LC-01-05-S4	15 cm	2.5 mm
LC-01-05-S5	20 cm	2.5 mm
LC-01-05-S6	25 cm	2.5 mm

LC-01-05-S7	15 cm	3.0 mm
LC-01-05-S8	20 cm	3.0 mm
LC-01-05-S9	25 cm	3.0 mm

Item Code	Size	Diameter
LC-02-05-SH1	15 cm	2.5 mm
LC-02-05-SH2	20 cm	2.5 mm
LC-02-05-SH3	25 cm	2.5 mm
LC-02-05-SH4	30 cm	2.5 mm
LC-02-05-SH5	35 cm	2.5 mm

LC-02-05-SH6	15 cm	3.0 mm
LC-02-05-SH7	20 cm	3.0 mm
LC-02-05-SH8	25 cm	3.0 mm
LC-02-05-SH9	30 cm	3.0 mm
LC-02-05-SH10	35 cm	3.0 mm

LC-02-05-SH11	15 cm	3.5 mm
LC-02-05-SH12	20 cm	3.5 mm
LC-02-05-SH13	25 cm	3.5 mm
LC-02-05-SH14	30 cm	3.5 mm
LC-02-05-SH15	35 cm	3.5 mm

Liposuction Cannulas



with Threaded Fitting

Item Code	Size	Diameter
LC-03-05-T1	15 cm	2.5 mm
LC-03-05-T2	20 cm	2.5 mm
LC-03-05-T3	25 cm	2.5 mm
LC-03-05-T4	30 cm	2.5 mm
LC-03-05-T5	35 cm	2.5 mm

LC-03-05-T6	15 cm	3.0 mm
LC-03-05-T7	20 cm	3.0 mm
LC-03-05-T8	25 cm	3.0 mm
LC-03-05-T9	30 cm	3.0 mm
LC-03-05-T10	35 cm	3.0 mm

LC-03-05-T11	15 cm	3.5 mm
LC-03-05-T12	20 cm	3.5 mm
LC-03-05-T13	25 cm	3.5 mm
LC-03-05-T14	30 cm	3.5 mm
LC-03-05-T15	35 cm	3.5 mm



with Mini Threaded Fitting

Item Code	Size	Diameter
LC-03-05-MT1	15 cm	2.5 mm
LC-03-05-MT2	20 cm	2.5 mm
LC-03-05-MT3	25 cm	2.5 mm
LC-03-05-MT4	30 cm	2.5 mm
LC-03-05-MT5	35 cm	2.5 mm

LC-03-05-MT6	15 cm	3.0 mm
LC-03-05-MT7	20 cm	3.0 mm
LC-03-05-MT8	25 cm	3.0 mm
LC-03-05-MT9	30 cm	3.0 mm
LC-03-05-MT10	35 cm	3.0 mm

LC-03-05-MT11	15 cm	3.5 mm
LC-03-05-MT12	20 cm	3.5 mm
LC-03-05-MT13	25 cm	3.5 mm
LC-03-05-MT14	30 cm	3.5 mm
LC-03-05-MT15	35 cm	3.5 mm



Three Port Harvester Cannula, Model 4



with Luer Lock Connector

Item Code	Size	Diameter
LC-01-06-L1	12 cm	1.5 mm
LC-01-06-L2	15cm	1.5 mm
LC-01-06-L3	20 cm	1.5 mm
LC-01-06-L4	25 cm	1.5 mm

LC-01-06-L5	12 cm	2.0 mm
LC-01-06-L6	15cm	2.0 mm
LC-01-06-L7	20 cm	2.0 mm
LC-01-06-L8	25 cm	2.0 mm

LC-01-06-L9	12 cm	2.5 mm
LC-01-06-L10	15cm	2.5 mm
LC-01-06-L11	20 cm	2.5 mm
LC-01-06-L12	25 cm	2.5 mm

LC-01-06-L13	12 cm	3.0 mm
LC-01-06-L14	15cm	3.0 mm
LC-01-06-L15	20 cm	3.0 mm
LC-01-06-L16	25 cm	3.0 mm



with Special Luer Lock Connector

Item Code	Size	Diameter
LC-01-06-S1	12 cm	1.5 mm
LC-01-06-S2	15cm	1.5 mm
LC-01-06-S3	20 cm	1.5 mm
LC-01-06-S4	25 cm	1.5 mm

LC-01-06-S5	12 cm	2.0 mm
LC-01-06-S6	15cm	2.0 mm
LC-01-06-S7	20 cm	2.0 mm
LC-01-06-S8	25 cm	2.0 mm

Item Code	Size	Diameter
LC-01-06-S9	12 cm	2.5 mm
LC-01-06-S10	15cm	2.5 mm
LC-01-06-S11	20 cm	2.5 mm
LC-01-06-S12	25 cm	2.5 mm

LC-01-06-S13	12 cm	3.0 mm
LC-01-06-S14	15cm	3.0 mm
LC-01-06-S15	20 cm	3.0 mm
LC-01-06-S16	25 cm	3.0 mm



with Super Handle

Item Code	Size	Diameter
LC-02-06-SH1	15 cm	2.5 mm
LC-02-06-SH2	20 cm	2.5 mm
LC-02-06-SH3	25 cm	2.5 mm
LC-02-06-SH4	30 cm	2.5 mm
LC-02-06-SH5	35 cm	2.5 mm

LC-02-06-SH6	15 cm	3.0 mm
LC-02-06-SH7	20 cm	3.0 mm
LC-02-06-SH8	25 cm	3.0 mm
LC-02-06-SH9	30 cm	3.0 mm
LC-02-06-SH10	35 cm	3.0 mm

LC-02-06-SH11	15 cm	3.5 mm
LC-02-06-SH12	20 cm	3.5 mm
LC-02-06-SH13	25 cm	3.5 mm
LC-02-06-SH14	30 cm	3.5 mm
LC-02-06-SH15	35 cm	3.5 mm

LC-02-06-SH16	15 cm	4.0 mm
LC-02-06-SH17	20 cm	4.0 mm
LC-02-06-SH18	25 cm	4.0 mm
LC-02-06-SH19	30 cm	4.0 mm
LC-02-06-SH20	35 cm	4.0 mm

Liposuction Cannulas



Item Code	Size	Diameter
LC-02-06-SH21	15 cm	4.5 mm
LC-02-06-SH22	20 cm	4.5 mm
LC-02-06-SH23	25 cm	4.5 mm
LC-02-06-SH24	30 cm	4.5 mm
LC-02-06-SH25	35 cm	4.5 mm



with Threaded Fitting



with Mini Threaded Fitting

Item Code	Size	Diameter
LC-03-06-T1	15 cm	2.5 mm
LC-03-06-T2	20 cm	2.5 mm
LC-03-06-T3	25 cm	2.5 mm
LC-03-06-T4	30 cm	2.5 mm
LC-03-06-T5	35 cm	2.5 mm

LC-03-06-T6	15 cm	3.0 mm
LC-03-06-T7	20 cm	3.0 mm
LC-03-06-T8	25 cm	3.0 mm
LC-03-06-T9	30 cm	3.0 mm
LC-03-06-T10	35 cm	3.0 mm

LC-03-06-T11	15 cm	3.5 mm
LC-03-06-T12	20 cm	3.5 mm
LC-03-06-T13	25 cm	3.5 mm
LC-03-06-T14	30 cm	3.5 mm
LC-03-06-T15	35 cm	3.5 mm

LC-03-06-T16	15 cm	4.0 mm
LC-03-06-T17	20 cm	4.0 mm
LC-03-06-T18	25 cm	4.0 mm
LC-03-06-T19	30 cm	4.0 mm
LC-03-06-T20	35 cm	4.0 mm

LC-03-06-T21	15 cm	4.5 mm
LC-03-06-T22	20 cm	4.5 mm
LC-03-06-T23	25 cm	4.5 mm
LC-03-06-T24	30 cm	4.5 mm
LC-03-06-T25	35 cm	4.5 mm

Item Code	Size	Diameter
LC-03-06-MT1	15 cm	2.5 mm
LC-03-06-MT2	20 cm	2.5 mm
LC-03-06-MT3	25 cm	2.5 mm
LC-03-06-MT4	30 cm	2.5 mm
LC-03-06-MT5	35 cm	2.5 mm

LC-03-06-MT6	15 cm	3.0 mm
LC-03-06-MT7	20 cm	3.0 mm
LC-03-06-MT8	25 cm	3.0 mm
LC-03-06-MT9	30 cm	3.0 mm
LC-03-06-MT10	35 cm	3.0 mm

LC-03-06-MT11	15 cm	3.5 mm
LC-03-06-MT12	20 cm	3.5 mm
LC-03-06-MT13	25 cm	3.5 mm
LC-03-06-MT14	30 cm	3.5 mm
LC-03-06-MT15	35 cm	3.5 mm

LC-03-06-MT16	15 cm	4.0 mm
LC-03-06-MT17	20 cm	4.0 mm
LC-03-06-MT18	25 cm	4.0 mm
LC-03-06-MT19	30 cm	4.0 mm
LC-03-06-MT20	35 cm	4.0 mm

LC-03-06-MT21	15 cm	4.5 mm
LC-03-06-MT22	20 cm	4.5 mm
LC-03-06-MT23	25 cm	4.5 mm
LC-03-06-MT24	30 cm	4.5 mm
LC-03-06-MT25	35 cm	4.5 mm



Rounded Blunt Tip Injector Cannula



with Luer Lock Connector



with Special Luer Lock Connector

Item Code	Size	Diameter
LC-01-07-L1	4 cm	1.0 mm
LC-01-07-L2	5 cm	1.0 mm
LC-01-07-L3	7 cm	1.0 mm
LC-01-07-L4	12 cm	1.0 mm
LC-01-07-L5	15 cm	1.0 mm
LC-01-07-L6	20 cm	1.0 mm
LC-01-07-L7	4 cm	1.5 mm
LC-01-07-L8	5 cm	1.5 mm
LC-01-07-L9	7 cm	1.5 mm
LC-01-07-L10	12 cm	1.5 mm
LC-01-07-L11	15 cm	1.5 mm
LC-01-07-L12	20 cm	1.5 mm

Item Code	Size	Diameter
LC-01-07-S1	4 cm	1.0 mm
LC-01-07-S2	5 cm	1.0 mm
LC-01-07-S3	7 cm	1.0 mm
LC-01-07-S4	12 cm	1.0 mm
LC-01-07-S5	15 cm	1.0 mm
LC-01-07-S6	20 cm	1.0 mm
LC-01-07-S7	4 cm	1.5 mm
LC-01-07-S8	5 cm	1.5 mm
LC-01-07-S9	7 cm	1.5 mm
LC-01-07-S10	12 cm	1.5 mm
LC-01-07-S11	15 cm	1.5 mm
LC-01-07-S12	20 cm	1.5 mm



Little Blunt Tip Injector Cannula



with Luer Lock Connector



with Special Luer Lock Connector

Item Code	Size	Diameter
LC-01-08-L1	4 cm	1.0 mm
LC-01-08-L2	5 cm	1.0 mm
LC-01-08-L3	7 cm	1.0 mm
LC-01-08-L4	4 cm	1.5 mm
LC-01-08-L5	5 cm	1.5 mm
LC-01-08-L6	7 cm	1.5 mm

Item Code	Size	Diameter
LC-01-08-S1	4 cm	1.0 mm
LC-01-08-S2	5 cm	1.0 mm
LC-01-08-S3	7 cm	1.0 mm
LC-01-08-S4	4 cm	1.5 mm
LC-01-08-S5	5 cm	1.5 mm
LC-01-08-S6	7 cm	1.5 mm



Spoon Tip Injector Cannula



with Luer Lock Connector



with Special Luer Lock Connector

Item Code	Size	Diameter
LC-01-09-L1	7 cm	1.5 mm
LC-01-09-L2	9 cm	1.5 mm
LC-01-09-L3	12 cm	1.5 mm
LC-01-09-L4	15cm	1.5 mm
LC-01-09-L5	20 cm	1.5 mm
LC-01-09-L6	25 cm	1.5 mm
LC-01-09-L7	7 cm	2.0 mm
LC-01-09-L8	9 cm	2.0 mm
LC-01-09-L9	12 cm	2.0 mm
LC-01-09-L10	15cm	2.0 mm
LC-01-09-L11	20 cm	2.0 mm
LC-01-09-L12	25 cm	2.0 mm
LC-01-09-L13	7 cm	2.5 mm
LC-01-09-L14	9 cm	2.5 mm
LC-01-09-L15	12 cm	2.5 mm
LC-01-09-L16	15cm	2.5 mm
LC-01-09-L17	20 cm	2.5 mm
LC-01-09-L18	25 cm	2.5 mm
LC-01-09-L19	7 cm	3.5 mm
LC-01-09-L20	9 cm	3.5 mm
LC-01-09-L21	12 cm	3.5 mm
LC-01-09-L22	15cm	3.5 mm
LC-01-09-L23	20 cm	3.5 mm
LC-01-09-L24	25 cm	3.5 mm

Item Code	Size	Diameter
LC-01-09-S1	7 cm	1.5 mm
LC-01-09-S2	9 cm	1.5 mm
LC-01-09-S3	12 cm	1.5 mm
LC-01-09-S4	15cm	1.5 mm
LC-01-09-S5	20 cm	1.5 mm
LC-01-09-S6	25 cm	1.5 mm
LC-01-09-S7	7 cm	2.0 mm
LC-01-09-S8	9 cm	2.0 mm
LC-01-09-S9	12 cm	2.0 mm
LC-01-09-S10	15cm	2.0 mm
LC-01-09-S11	20 cm	2.0 mm
LC-01-09-S12	25 cm	2.0 mm
LC-01-09-S13	7 cm	2.5 mm
LC-01-09-S14	9 cm	2.5 mm
LC-01-09-S15	12 cm	2.5 mm
LC-01-09-S16	15cm	2.5 mm
LC-01-09-S17	20 cm	2.5 mm
LC-01-09-S18	25 cm	2.5 mm
LC-01-09-S19	7 cm	3.5 mm
LC-01-09-S20	9 cm	3.5 mm
LC-01-09-S21	12 cm	3.5 mm
LC-01-09-S22	15cm	3.5 mm
LC-01-09-S23	20 cm	3.5 mm
LC-01-09-S24	25 cm	3.5 mm

Liposuction Cannulas



with Super Handle

Item Code	Size	Diameter
LC-02-09-SH1	15 cm	2.5 mm
LC-02-09-SH2	20 cm	2.5 mm
LC-02-09-SH3	25 cm	2.5 mm

LC-02-09-SH4	15 cm	3.0 mm
LC-02-09-SH5	20 cm	3.0 mm
LC-02-09-SH6	25 cm	3.0 mm

LC-02-09-SH7	15 cm	3.5 mm
LC-02-09-SH8	20 cm	3.5 mm
LC-02-09-SH9	25 cm	3.5 mm



with Mini Threaded Fitting

Item Code	Size	Diameter
LC-03-09-MT1	15 cm	2.5 mm
LC-03-09-MT2	20 cm	2.5 mm
LC-03-09-MT3	25 cm	2.5 mm

LC-03-09-MT4	15 cm	3.0 mm
LC-03-09-MT5	20 cm	3.0 mm
LC-03-09-MT6	25 cm	3.0 mm

LC-03-09-MT7	15 cm	3.5 mm
LC-03-09-MT8	20 cm	3.5 mm
LC-03-09-MT9	25 cm	3.5 mm



with Threaded Fitting

Item Code	Size	Diameter
LC-03-09-T1	15 cm	2.5 mm
LC-03-09-T2	20 cm	2.5 mm
LC-03-09-T3	25 cm	2.5 mm

LC-03-09-T4	15 cm	3.0 mm
LC-03-09-T5	20 cm	3.0 mm
LC-03-09-T6	25 cm	3.0 mm

LC-03-09-T7	15 cm	3.5 mm
LC-03-09-T8	20 cm	3.5 mm
LC-03-09-T9	25 cm	3.5 mm



Liposuction Cannulas

Graduated Spiral Ports Injector Cannula



with Luer Lock Connector



with Special Luer Lock Connector

Item Code	Size	Diameter
LC-01-10-L1	5 cm	1.0 mm

Item Code	Size	Diameter
LC-01-10-S1	5 cm	1.0 mm



ZIMAIZ
INTERNATIONAL



Tapered Tip Two Ports Cannula



with Luer Lock Connector



with Super Handle

Item Code	Size	Diameter
LC-01-11-L1.	15 cm	2.0 mm
LC-01-11-L2	20 cm	2.0 mm
LC-01-11-L3	25 cm	2.0 mm
LC-01-11-L4	15 cm	2.5 mm
LC-01-11-L5	20 cm	2.5 mm
LC-01-11-L6	25 cm	2.5 mm
LC-01-11-L7	15 cm	3.0 mm
LC-01-11-L8	20 cm	3.0 mm
LC-01-11-L9	25 cm	3.0 mm



with Special Luer Lock Connector

Item Code	Size	Diameter
LC-01-11-S1.	15 cm	2.0 mm
LC-01-11-S2	20 cm	2.0 mm
LC-01-11-S3	25 cm	2.0 mm
LC-01-11-S4	15 cm	2.5 mm
LC-01-11-S5	20 cm	2.5 mm
LC-01-11-S6	25 cm	2.5 mm
LC-01-11-S7	15 cm	3.0 mm
LC-01-11-S8	20 cm	3.0 mm
LC-01-11-S9	25 cm	3.0 mm

Item Code	Size	Diameter
LC-02-11-SH1	15 cm	2.5 mm
LC-02-11-SH2	20 cm	2.5 mm
LC-02-11-SH3	25 cm	2.5 mm
LC-02-11-SH4	30 cm	2.5 mm
LC-02-11-SH5	35 cm	2.5 mm
LC-02-11-SH6	15 cm	3.0 mm
LC-02-11-SH7	20 cm	3.0 mm
LC-02-11-SH8	25 cm	3.0 mm
LC-02-11-SH9	30 cm	3.0 mm
LC-02-11-SH10	35 cm	3.0 mm
LC-02-11-SH11	15 cm	3.5 mm
LC-02-11-SH12	20 cm	3.5 mm
LC-02-11-SH13	25 cm	3.5 mm
LC-02-11-SH14	30 cm	3.5 mm
LC-02-11-SH15	35 cm	3.5 mm

LC-02-11-SH16	15 cm	4.0 mm
LC-02-11-SH17	20 cm	4.0 mm
LC-02-11-SH18	25 cm	4.0 mm
LC-02-11-SH19	30 cm	4.0 mm
LC-02-11-SH20	35 cm	4.0 mm

LC-02-11-SH21	15 cm	4.5 mm
LC-02-11-SH22	20 cm	4.5 mm
LC-02-11-SH23	25 cm	4.5 mm
LC-02-11-SH24	30 cm	4.5 mm
LC-02-11-SH25	35 cm	4.5 mm



Liposuction Cannulas



with Threaded Fitting

Item Code	Size	Diameter
LC-03-11-T1	15 cm	2.5 mm
LC-03-11-T2	20 cm	2.5 mm
LC-03-11-T3	25 cm	2.5 mm
LC-03-11-T4	30 cm	2.5 mm
LC-03-11-T5	35 cm	2.5 mm
LC-03-11-T6	15 cm	3.0 mm
LC-03-11-T7	20 cm	3.0 mm
LC-03-11-T8	25 cm	3.0 mm
LC-03-11-T9	30 cm	3.0 mm
LC-03-11-T10	35 cm	3.0 mm
LC-03-11-T11	15 cm	3.5 mm
LC-03-11-T12	20 cm	3.5 mm
LC-03-11-T13	25 cm	3.5 mm
LC-03-11-T14	30 cm	3.5 mm
LC-03-11-T15	35 cm	3.5 mm
LC-03-11-T16	15 cm	4.0 mm
LC-03-11-T17	20 cm	4.0 mm
LC-03-11-T18	25 cm	4.0 mm
LC-03-11-T19	30 cm	4.0 mm
LC-03-11-T20	35 cm	4.0 mm
LC-03-11-T21	15 cm	4.5 mm
LC-03-11-T22	20 cm	4.5 mm
LC-03-11-T23	25 cm	4.5 mm
LC-03-11-T24	30 cm	4.5 mm
LC-03-11-T25	35 cm	4.5 mm



with Mini Threaded Fitting

Item Code	Size	Diameter
LC-03-11-MT1	15 cm	2.5 mm
LC-03-11-MT2	20 cm	2.5 mm
LC-03-11-MT3	25 cm	2.5 mm
LC-03-11-MT4	30 cm	2.5 mm
LC-03-11-MT5	35 cm	2.5 mm
LC-03-11-MT6	15 cm	3.0 mm
LC-03-11-MT7	20 cm	3.0 mm
LC-03-11-MT8	25 cm	3.0 mm
LC-03-11-MT9	30 cm	3.0 mm
LC-03-11-MT10	35 cm	3.0 mm
LC-03-11-MT11	15 cm	3.5 mm
LC-03-11-MT12	20 cm	3.5 mm
LC-03-11-MT13	25 cm	3.5 mm
LC-03-11-MT14	30 cm	3.5 mm
LC-03-11-MT15	35 cm	3.5 mm
LC-03-11-MT16	15 cm	4.0 mm
LC-03-11-MT17	20 cm	4.0 mm
LC-03-11-MT18	25 cm	4.0 mm
LC-03-11-MT19	30 cm	4.0 mm
LC-03-11-MT20	35 cm	4.0 mm
LC-03-11-MT21	15 cm	4.5 mm
LC-03-11-MT22	20 cm	4.5 mm
LC-03-11-MT23	25 cm	4.5 mm
LC-03-11-MT24	30 cm	4.5 mm
LC-03-11-MT25	35 cm	4.5 mm



Rounded Tip Two Ports Cannula



with Luer Lock Connector

Item Code	Size	Diameter
LC-01-12-L1	15cm	2.0 mm
LC-01-12-L2	20 cm	2.0 mm
LC-01-12-L3	25 cm	2.0 mm
LC-01-12-L4	15cm	2.5 mm
LC-01-12-L5	20 cm	2.5 mm
LC-01-12-L6	25 cm	2.5 mm
LC-01-12-L7	15cm	3.0 mm
LC-01-12-L8	20 cm	3.0 mm
LC-01-12-L9	25 cm	3.0 mm



with Special Luer Lock Connector

Item Code	Size	Diameter
LC-01-12-S1	15cm	2.0 mm
LC-01-12-S2	20 cm	2.0 mm
LC-01-12-S3	25 cm	2.0 mm
LC-01-12-S4	15cm	2.5 mm
LC-01-12-S5	20 cm	2.5 mm
LC-01-12-S6	25 cm	2.5 mm
LC-01-12-S7	15cm	3.0 mm
LC-01-12-S8	20 cm	3.0 mm
LC-01-12-S9	25 cm	3.0 mm



with Super Handle

Item Code	Size	Diameter
LC-02-12-SH1	15 cm	2.5 mm
LC-02-12-SH2	20 cm	2.5 mm
LC-02-12-SH3	25 cm	2.5 mm
LC-02-12-SH4	30 cm	2.5 mm
LC-02-12-SH5	35 cm	2.5 mm
LC-02-12-SH6	15 cm	3.0 mm
LC-02-12-SH7	20 cm	3.0 mm
LC-02-12-SH8	25 cm	3.0 mm
LC-02-12-SH9	30 cm	3.0 mm
LC-02-12-SH10	35 cm	3.0 mm
LC-02-12-SH11	15 cm	3.5 mm
LC-02-12-SH12	20 cm	3.5 mm
LC-02-12-SH13	25 cm	3.5 mm
LC-02-12-SH14	30 cm	3.5 mm
LC-02-12-SH15	35 cm	3.5 mm
LC-02-12-SH16	15 cm	4.0 mm
LC-02-12-SH17	20 cm	4.0 mm
LC-02-12-SH18	25 cm	4.0 mm
LC-02-12-SH19	30 cm	4.0 mm
LC-02-12-SH20	35 cm	4.0 mm
LC-02-12-SH21	15 cm	4.5 mm
LC-02-12-SH22	20 cm	4.5 mm
LC-02-12-SH23	25 cm	4.5 mm
LC-02-12-SH24	30 cm	4.5 mm
LC-02-12-SH25	35 cm	4.5 mm



Liposuction Cannulas



with Threaded Fitting

Item Code	Size	Diameter
LC-03-12-T1	15 cm	2.5 mm
LC-03-12-T2	20 cm	2.5 mm
LC-03-12-T3	25 cm	2.5 mm
LC-03-12-T4	30 cm	2.5 mm
LC-03-12-T5	35 cm	2.5 mm
LC-03-12-T6	15 cm	3.0 mm
LC-03-12-T7	20 cm	3.0 mm
LC-03-12-T8	25 cm	3.0 mm
LC-03-12-T9	30 cm	3.0 mm
LC-03-12-T10	35 cm	3.0 mm
LC-03-12-T11	15 cm	3.5 mm
LC-03-12-T12	20 cm	3.5 mm
LC-03-12-T13	25 cm	3.5 mm
LC-03-12-T14	30 cm	3.5 mm
LC-03-12-T15	35 cm	3.5 mm
LC-03-12-T16	15 cm	4.0 mm
LC-03-12-T17	20 cm	4.0 mm
LC-03-12-T18	25 cm	4.0 mm
LC-03-12-T19	30 cm	4.0 mm
LC-03-12-T20	35 cm	4.0 mm
LC-03-12-T21	15 cm	4.5 mm
LC-03-12-T22	20 cm	4.5 mm
LC-03-12-T23	25 cm	4.5 mm
LC-03-12-T24	30 cm	4.5 mm
LC-03-12-T25	35 cm	4.5 mm



with Mini Threaded Fitting

Item Code	Size	Diameter
LC-03-12-MT1	15 cm	2.5 mm
LC-03-12-MT2	20 cm	2.5 mm
LC-03-12-MT3	25 cm	2.5 mm
LC-03-12-MT4	30 cm	2.5 mm
LC-03-12-MT5	35 cm	2.5 mm
LC-03-12-MT6	15 cm	3.0 mm
LC-03-12-MT7	20 cm	3.0 mm
LC-03-12-MT8	25 cm	3.0 mm
LC-03-12-MT9	30 cm	3.0 mm
LC-03-12-MT10	35 cm	3.0 mm
LC-03-12-MT11	15 cm	3.5 mm
LC-03-12-MT12	20 cm	3.5 mm
LC-03-12-MT13	25 cm	3.5 mm
LC-03-12-MT14	30 cm	3.5 mm
LC-03-12-MT15	35 cm	3.5 mm
LC-03-12-MT16	15 cm	4.0 mm
LC-03-12-MT17	20 cm	4.0 mm
LC-03-12-MT18	25 cm	4.0 mm
LC-03-12-MT19	30 cm	4.0 mm
LC-03-12-MT20	35 cm	4.0 mm
LC-03-12-MT21	15 cm	4.5 mm
LC-03-12-MT22	20 cm	4.5 mm
LC-03-12-MT23	25 cm	4.5 mm
LC-03-12-MT24	30 cm	4.5 mm
LC-03-12-MT25	35 cm	4.5 mm



Three Ports Pyramid Cannula



with Luer Lock Connector

Item Code	Size	Diameter
LC-01-13-L1	12 cm	1.5 mm
LC-01-13-L2	15 cm	1.5 mm
LC-01-13-L3	20 cm	1.5 mm
LC-01-13-L4	25 cm	1.5 mm

LC-01-13-L5	12 cm	2.0 mm
LC-01-13-L6	15 cm	2.0 mm
LC-01-13-L7	20 cm	2.0 mm
LC-01-13-L8	25 cm	2.0 mm

LC-01-13-L9	12 cm	2.5 mm
LC-01-13-L10	15 cm	2.5 mm
LC-01-13-L11	20 cm	2.5 mm
LC-01-13-L12	25 cm	2.5 mm

LC-01-13-L13	12 cm	3.0 mm
LC-01-13-L14	15 cm	3.0 mm
LC-01-13-L15	20 cm	3.0 mm
LC-01-13-L16	25 cm	3.0 mm



with Special Luer Lock Connector

Item Code	Size	Diameter
LC-01-13-S9	12 cm	2.5 mm
LC-01-13-S10	15 cm	2.5 mm
LC-01-13-S11	20 cm	2.5 mm
LC-01-13-S12	25 cm	2.5 mm

LC-01-13-S13	12 cm	3.0 mm
LC-01-13-S14	15 cm	3.0 mm
LC-01-13-S15	20 cm	3.0 mm
LC-01-13-S16	25 cm	3.0 mm

Item Code	Size	Diameter
LC-01-13-S9	12 cm	2.5 mm
LC-01-13-S10	15 cm	2.5 mm
LC-01-13-S11	20 cm	2.5 mm
LC-01-13-S12	25 cm	2.5 mm

LC-01-13-S13	12 cm	3.0 mm
LC-01-13-S14	15 cm	3.0 mm
LC-01-13-S15	20 cm	3.0 mm
LC-01-13-S16	25 cm	3.0 mm



with Super Handle

Item Code	Size	Diameter
LC-02-13-SH1	15 cm	2.5 mm
LC-02-13-SH2	20 cm	2.5 mm
LC-02-13-SH3	25 cm	2.5 mm
LC-02-13-SH4	30 cm	2.5 mm
LC-02-13-SH5	35 cm	2.5 mm

LC-02-13-SH6	15 cm	3.0 mm
LC-02-13-SH7	20 cm	3.0 mm
LC-02-13-SH8	25 cm	3.0 mm
LC-02-13-SH9	30 cm	3.0 mm
LC-02-13-SH10	35 cm	3.0 mm

LC-02-13-SH11	15 cm	3.5 mm
LC-02-13-SH12	20 cm	3.5 mm
LC-02-13-SH13	25 cm	3.5 mm
LC-02-13-SH14	30 cm	3.5 mm
LC-02-13-SH15	35 cm	3.5 mm

LC-02-13-SH16	15 cm	4.0 mm
LC-02-13-SH17	20 cm	4.0 mm
LC-02-13-SH18	25 cm	4.0 mm
LC-02-13-SH19	30 cm	4.0 mm
LC-02-13-SH20	35 cm	4.0 mm

LC-02-13-SH21	15 cm	4.5 mm
LC-02-13-SH22	20 cm	4.5 mm
LC-02-13-SH23	25 cm	4.5 mm
LC-02-13-SH24	30 cm	4.5 mm
LC-02-13-SH25	35 cm	4.5 mm



Liposuction Cannulas



with Threaded Fitting

Item Code	Size	Diameter
LC-03-13-T1	15 cm	2.5 mm
LC-03-13-T2	20 cm	2.5 mm
LC-03-13-T3	25 cm	2.5 mm
LC-03-13-T4	30 cm	2.5 mm
LC-03-13-T5	35 cm	2.5 mm
LC-03-13-T6	15 cm	3.0 mm
LC-03-13-T7	20 cm	3.0 mm
LC-03-13-T8	25 cm	3.0 mm
LC-03-13-T9	30 cm	3.0 mm
LC-03-13-T10	35 cm	3.0 mm
LC-03-13-T11	15 cm	3.5 mm
LC-03-13-T12	20 cm	3.5 mm
LC-03-13-T13	25 cm	3.5 mm
LC-03-13-T14	30 cm	3.5 mm
LC-03-13-T15	35 cm	3.5 mm
LC-03-13-T16	15 cm	4.0 mm
LC-03-13-T17	20 cm	4.0 mm
LC-03-13-T18	25 cm	4.0 mm
LC-03-13-T19	30 cm	4.0 mm
LC-03-13-T20	35 cm	4.0 mm
LC-03-13-T21	15 cm	4.5 mm
LC-03-13-T22	20 cm	4.5 mm
LC-03-13-T23	25 cm	4.5 mm
LC-03-13-T24	30 cm	4.5 mm
LC-03-13-T25	35 cm	4.5 mm



with Mini Threaded Fitting

Item Code	Size	Diameter
LC-03-13-MT1	15 cm	2.5 mm
LC-03-13-MT2	20 cm	2.5 mm
LC-03-13-MT3	25 cm	2.5 mm
LC-03-13-MT4	30 cm	2.5 mm
LC-03-13-MT5	35 cm	2.5 mm
LC-03-13-MT6	15 cm	3.0 mm
LC-03-13-MT7	20 cm	3.0 mm
LC-03-13-MT8	25 cm	3.0 mm
LC-03-13-MT9	30 cm	3.0 mm
LC-03-13-MT10	35 cm	3.0 mm
LC-03-13-MT11	15 cm	3.5 mm
LC-03-13-MT12	20 cm	3.5 mm
LC-03-13-MT13	25 cm	3.5 mm
LC-03-13-MT14	30 cm	3.5 mm
LC-03-13-MT15	35 cm	3.5 mm
LC-03-13-MT16	15 cm	4.0 mm
LC-03-13-MT17	20 cm	4.0 mm
LC-03-13-MT18	25 cm	4.0 mm
LC-03-13-MT19	30 cm	4.0 mm
LC-03-13-MT20	35 cm	4.0 mm
LC-03-13-MT21	15 cm	4.5 mm
LC-03-13-MT22	20 cm	4.5 mm
LC-03-13-MT23	25 cm	4.5 mm
LC-03-13-MT24	30 cm	4.5 mm
LC-03-13-MT25	35 cm	4.5 mm



Tapered Tip speed cannula Cannula with multiple holes



with Luer Lock Connector



with Threaded Fitting

Item Code	Size	Diameter
LC-01-14-L1	15cm	3.0 mm
LC-01-14-L2	20 cm	3.0 mm
LC-01-14-L3	25 cm	3.0 mm

Item Code	Size	Diameter
LC-03-14-T1	15 cm	3.0 mm
LC-03-14-T2	20 cm	3.0 mm
LC-03-14-T3	25 cm	3.0 mm
LC-03-14-T4	30 cm	3.0 mm
LC-03-14-T5	35 cm	3.0 mm



with Special Luer Lock Connector

LC-03-14-T6	15 cm	3.5 mm
LC-03-14-T7	20 cm	3.5 mm
LC-03-14-T8	25 cm	3.5 mm
LC-03-14-T9	30 cm	3.5 mm
LC-03-14-T10	35 cm	3.5 mm

Item Code	Size	Diameter
LC-01-14-S1	15cm	3.0 mm
LC-01-14-S2	20 cm	3.0 mm
LC-01-14-S3	25 cm	3.0 mm



with Mini Threaded Fitting



with Super Handle

Item Code	Size	Diameter
LC-03-14-MT1	15 cm	3.0 mm
LC-03-14-MT2	20 cm	3.0 mm
LC-03-14-MT3	25 cm	3.0 mm
LC-03-14-MT4	30 cm	3.0 mm
LC-03-14-MT5	35 cm	3.0 mm

Item Code	Size	Diameter
LC-02-14-SH1	15 cm	3.0 mm
LC-02-14-SH2	20 cm	3.0 mm
LC-02-14-SH3	25 cm	3.0 mm
LC-02-14-SH4	30 cm	3.0 mm
LC-02-14-SH5	35 cm	3.0 mm

LC-03-14-MT6	15 cm	3.5 mm
LC-03-14-MT7	20 cm	3.5 mm
LC-03-14-MT8	25 cm	3.5 mm
LC-03-14-MT9	30 cm	3.5 mm
LC-03-14-MT10	35 cm	3.5 mm

LC-02-14-SH6	15 cm	3.5 mm
LC-02-14-SH7	20 cm	3.5 mm
LC-02-14-SH8	25 cm	3.5 mm
LC-02-14-SH9	30 cm	3.5 mm
LC-02-14-SH10	35 cm	3.5 mm



Liposuction Cannulas

Liposuction Cannulas, One Central Hole, Two Lateral Holes



with Luer Lock Connector

Item Code	Size	Diameter
LC-01-15-L1	20 cm	3.0 mm
LC-01-15-L2	30 cm	3.0 mm
LC-01-15-L3	40 cm	3.0 mm
LC-01-15-L4	20 cm	4.0 mm
LC-01-15-L5	30 cm	4.0 mm
LC-01-15-L6	40 cm	4.0 mm



with Special Luer Lock Connector

Item Code	Size	Diameter
LC-01-15-S1	20 cm	3.0 mm
LC-01-15-S2	30 cm	3.0 mm
LC-01-15-S3	40 cm	3.0 mm
LC-01-15-S4	20 cm	4.0 mm
LC-01-15-S5	30 cm	4.0 mm
LC-01-15-S6	40 cm	4.0 mm



with Super Handle

Item Code	Size	Diameter
LC-02-15-SH1	20 cm	3.0 mm
LC-02-15-SH2	30 cm	3.0 mm
LC-02-15-SH3	40 cm	3.0 mm
LC-02-15-SH4	20 cm	4.0 mm
LC-02-15-SH5	30 cm	4.0 mm
LC-02-15-SH6	40 cm	4.0 mm
LC-02-15-SH7	20 cm	5.0 mm
LC-02-15-SH8	30 cm	5.0 mm
LC-02-15-SH9	40 cm	5.0 mm
LC-02-15-SH10	20 cm	6.0 mm
LC-02-15-SH11	30 cm	6.0 mm
LC-02-15-SH12	40 cm	6.0 mm

Liposuction Cannulas



with Threaded Fitting

Item Code	Size	Diameter
LC-03-15-T1	20 cm	3.0 mm
LC-03-15-T2	30 cm	3.0 mm
LC-03-15-T3	40 cm	3.0 mm
LC-03-15-T4	20 cm	4.0 mm
LC-03-15-T5	30 cm	4.0 mm
LC-03-15-T6	40 cm	4.0 mm
LC-03-15-T7	20 cm	5.0 mm
LC-03-15-T8	30 cm	5.0 mm
LC-03-15-T9	40 cm	5.0 mm
LC-03-15-T10	20 cm	6.0 mm
LC-03-15-T11	30 cm	6.0 mm
LC-03-15-T12	40 cm	6.0 mm



with Mini Threaded Fitting

Item Code	Size	Diameter
LC-03-15-MT1	20 cm	3.0 mm
LC-03-15-MT2	30 cm	3.0 mm
LC-03-15-MT3	40 cm	3.0 mm
LC-03-15-MT4	20 cm	4.0 mm
LC-03-15-MT5	30 cm	4.0 mm
LC-03-15-MT6	40 cm	4.0 mm
LC-03-15-MT7	20 cm	5.0 mm
LC-03-15-MT8	30 cm	5.0 mm
LC-03-15-MT9	40 cm	5.0 mm
LC-03-15-MT10	20 cm	6.0 mm
LC-03-15-MT11	30 cm	6.0 mm
LC-03-15-MT12	40 cm	6.0 mm



Liposuction Cannulas

Liposuction Cannulas, Two Lateral Holes, One Central Hole



with Luer Lock Connector

Item Code	Size	Diameter
LC-01-16-L1	20 cm	3.0 mm
LC-01-16-L2	30 cm	3.0 mm
LC-01-16-L3	40 cm	3.0 mm

LC-01-16-L4	20 cm	4.0 mm
LC-01-16-L5	30 cm	4.0 mm
LC-01-16-L6	40 cm	4.0 mm



with Special Luer Lock Connector

Item Code	Size	Diameter
LC-01-16-S1	20 cm	3.0 mm
LC-01-16-S2	30 cm	3.0 mm
LC-01-16-S3	40 cm	3.0 mm

LC-01-16-S4	20 cm	4.0 mm
LC-01-16-S5	30 cm	4.0 mm
LC-01-16-S6	40 cm	4.0 mm



with Super Handle

Item Code	Size	Diameter
LC-02-16-SH1	20 cm	3.0 mm
LC-02-16-SH2	30 cm	3.0 mm
LC-02-16-SH3	40 cm	3.0 mm

Item Code	Size	Diameter
LC-02-16-SH4	20 cm	4.0 mm
LC-02-16-SH5	30 cm	4.0 mm
LC-02-16-SH6	40 cm	4.0 mm

LC-02-16-SH7	20 cm	5.0 mm
LC-02-16-SH8	30 cm	5.0 mm
LC-02-16-SH9	40 cm	5.0 mm



with Threaded Fitting

Item Code	Size	Diameter
LC-03-16-T1	20 cm	3.0 mm
LC-03-16-T2	30 cm	3.0 mm
LC-03-16-T3	40 cm	3.0 mm

LC-03-16-T4	20 cm	4.0 mm
LC-03-16-T5	30 cm	4.0 mm
LC-03-16-T6	40 cm	4.0 mm

LC-03-16-T7	20 cm	5.0 mm
LC-03-16-T8	30 cm	5.0 mm
LC-03-16-T9	40 cm	5.0 mm



with Mini Threaded Fitting

Item Code	Size	Diameter
LC-03-16-MT1	20 cm	3.0 mm
LC-03-16-MT2	30 cm	3.0 mm
LC-03-16-MT3	40 cm	3.0 mm

LC-03-16-MT4	20 cm	4.0 mm
LC-03-16-MT5	30 cm	4.0 mm
LC-03-16-MT6	40 cm	4.0 mm

LC-03-16-MT7	20 cm	5.0 mm
LC-03-16-MT8	30 cm	5.0 mm
LC-03-16-MT9	40 cm	5.0 mm



Liposuction Cannulas With Three Holes Diagonal



with Luer Lock Connector

Item Code	Size	Diameter
LC-01-17-L1	20 cm	3.0 mm
LC-01-17-L2	30 cm	3.0 mm
LC-01-17-L3	40 cm	3.0 mm
LC-01-17-L4	20 cm	4.0 mm
LC-01-17-L5	30 cm	4.0 mm
LC-01-17-L6	40 cm	4.0 mm



with Special Luer Lock Connector

Item Code	Size	Diameter
LC-01-17-S1	20 cm	3.0 mm
LC-01-17-S2	30 cm	3.0 mm
LC-01-17-S3	40 cm	3.0 mm
LC-01-17-S4	20 cm	4.0 mm
LC-01-17-S5	30 cm	4.0 mm
LC-01-17-S6	40 cm	4.0 mm



with Super Handle

Item Code	Size	Diameter
LC-02-17-SH1	20 cm	3.0 mm
LC-02-17-SH2	30 cm	3.0 mm
LC-02-17-SH3	40 cm	3.0 mm
LC-02-17-SH4	20 cm	4.0 mm
LC-02-17-SH5	30 cm	4.0 mm
LC-02-17-SH6	40 cm	4.0 mm

Item Code	Size	Diameter
LC-02-17-SH7	20 cm	5.0 mm
LC-02-17-SH8	30 cm	5.0 mm
LC-02-17-SH9	40 cm	5.0 mm



with Threaded Fitting

Item Code	Size	Diameter
LC-03-17-T1	20 cm	3.0 mm
LC-03-17-T2	30 cm	3.0 mm
LC-03-17-T3	40 cm	3.0 mm

LC-03-17-T4	20 cm	4.0 mm
LC-03-17-T5	30 cm	4.0 mm
LC-03-17-T6	40 cm	4.0 mm

LC-03-17-T7	20 cm	5.0 mm
LC-03-17-T8	30 cm	5.0 mm
LC-03-17-T9	40 cm	5.0 mm



with Mini Threaded Fitting

Item Code	Size	Diameter
LC-03-17-MT1	20 cm	3.0 mm
LC-03-17-MT2	30 cm	3.0 mm
LC-03-17-MT3	40 cm	3.0 mm

LC-03-17-MT4	20 cm	4.0 mm
LC-03-17-MT5	30 cm	4.0 mm
LC-03-17-MT6	40 cm	4.0 mm

LC-03-17-MT7	20 cm	5.0 mm
LC-03-17-MT8	30 cm	5.0 mm
LC-03-17-MT9	40 cm	5.0 mm



Liposuction Cannulas

Liposuction Cannulas, One Central Hole, Two Lateral Holes



with Luer Lock Connector

Item Code	Size	Diameter
LC-01-18-L1	20 cm	4.0 mm
LC-01-18-L2	30 cm	4.0 mm
LC-01-18-L3	40 cm	4.0 mm



with Threaded Fitting

Item Code	Size	Diameter
LC-03-18-T1	20 cm	4.0 mm
LC-03-18-T2	30 cm	4.0 mm
LC-03-18-T3	40 cm	4.0 mm

LC-03-18-T4	20 cm	5.0 mm
LC-03-18-T5	30 cm	5.0 mm
LC-03-18-T6	40 cm	5.0 mm



with Special Luer Lock Connector

Item Code	Size	Diameter
LC-01-18-S1	20 cm	4.0 mm
LC-01-18-S2	30 cm	4.0 mm
LC-01-18-S3	40 cm	4.0 mm



with Mini Threaded Fitting

Item Code	Size	Diameter
LC-03-18-MT1	20 cm	4.0 mm
LC-03-18-MT2	30 cm	4.0 mm
LC-03-18-MT3	40 cm	4.0 mm

LC-03-18-MT4	20 cm	5.0 mm
LC-03-18-MT5	30 cm	5.0 mm
LC-03-18-MT6	40 cm	5.0 mm



with Super Handle

Item Code	Size	Diameter
LC-02-18-SH1	20 cm	4.0 mm
LC-02-18-SH2	30 cm	4.0 mm
LC-02-18-SH3	40 cm	4.0 mm

LC-02-18-SH4	20 cm	5.0 mm
LC-02-18-SH5	30 cm	5.0 mm
LC-02-18-SH6	40 cm	5.0 mm



Liposuction Cannula, Tip With Hole, One Central Hole



with Luer Lock Connector

Item Code	Size	Diameter
LC-01-19-L1	20 cm	3.0 mm
LC-01-19-L2	30 cm	3.0 mm
LC-01-19-L3	40 cm	3.0 mm



with Super Handle

Item Code	Size	Diameter
LC-02-19-SH1	20 cm	3.0 mm
LC-02-19-SH2	30 cm	3.0 mm
LC-02-19-SH3	40 cm	3.0 mm



with Special Luer Lock Connector

Item Code	Size	Diameter
LC-01-19-S1	20 cm	3.0 mm
LC-01-19-S2	30 cm	3.0 mm
LC-01-19-S3	40 cm	3.0 mm



with Threaded Fitting

Item Code	Size	Diameter
LC-03-19-T1	20 cm	3.0 mm
LC-03-19-T2	30 cm	3.0 mm
LC-03-19-T3	40 cm	3.0 mm



with Mini Threaded Fitting

Item Code	Size	Diameter
LC-03-19-MT1	20 cm	3.0 mm
LC-03-19-MT2	30 cm	3.0 mm
LC-03-19-MT3	40 cm	3.0 mm



Liposuction Cannulas

Toledo, one central hole, Fork shaped, rounded tips, dissecting surface between tips



with Luer Lock Connector



with Super Handle

Item Code	Size	Diameter
LC-01-20-L1	5 cm	2.0 mm
LC-01-20-L2	15 cm	2.0 mm
LC-01-20-L3	25 cm	2.0 mm
LC-01-20-L4	30 cm	2.0 mm

LC-01-20-L5	5 cm	3.0 mm
LC-01-20-L6	15 cm	3.0 mm
LC-01-20-L7	25 cm	3.0 mm
LC-01-20-L8	30 cm	3.0 mm

LC-01-20-L9	5 cm	4.0 mm
LC-01-20-L10	15 cm	4.0 mm
LC-01-20-L11	25 cm	4.0 mm
LC-01-20-L12	30 cm	4.0 mm

Item Code	Size	Diameter
LC-02-20-SH1	5 cm	2.0 mm
LC-02-20-SH2	15 cm	2.0 mm
LC-02-20-SH3	25 cm	2.0 mm
LC-02-20-SH4	30 cm	2.0 mm

LC-02-20-SH5	5 cm	3.0 mm
LC-02-20-SH6	15 cm	3.0 mm
LC-02-20-SH7	25 cm	3.0 mm
LC-02-20-SH8	30 cm	3.0 mm

LC-02-20-SH9	5 cm	4.0 mm
LC-02-20-SH10	15 cm	4.0 mm
LC-02-20-SH11	25 cm	4.0 mm
LC-02-20-SH12	30 cm	4.0 mm



with Special Luer Lock Connector

LC-02-20-SH13	5 cm	5.0 mm
LC-02-20-SH14	15 cm	5.0 mm
LC-02-20-SH15	25 cm	5.0 mm
LC-02-20-SH16	30 cm	5.0 mm

Item Code	Size	Diameter
LC-01-20-S1	5 cm	2.0 mm
LC-01-20-S2	15 cm	2.0 mm
LC-01-20-S3	25 cm	2.0 mm
LC-01-20-S4	30 cm	2.0 mm

LC-01-20-S5	5 cm	3.0 mm
LC-01-20-S6	15 cm	3.0 mm
LC-01-20-S7	25 cm	3.0 mm
LC-01-20-S8	30 cm	3.0 mm

LC-01-20-S9	5 cm	4.0 mm
LC-01-20-S10	15 cm	4.0 mm
LC-01-20-S11	25 cm	4.0 mm
LC-01-20-S12	30 cm	4.0 mm

Liposuction Cannulas



with Threaded Fitting

Item Code	Size	Diameter
LC-03-20-T1	5 cm	2.0 mm
LC-03-20-T2	15 cm	2.0 mm
LC-03-20-T3	25 cm	2.0 mm
LC-03-20-T4	30 cm	2.0 mm
LC-03-20-T5	5 cm	3.0 mm
LC-03-20-T6	15 cm	3.0 mm
LC-03-20-T7	25 cm	3.0 mm
LC-03-20-T8	30 cm	3.0 mm
LC-03-20-T9	5 cm	4.0 mm
LC-03-20-T10	15 cm	4.0 mm
LC-03-20-T11	25 cm	4.0 mm
LC-03-20-T12	30 cm	4.0 mm
LC-03-20-T13	5 cm	5.0 mm
LC-03-20-T14	15 cm	5.0 mm
LC-03-20-T15	25 cm	5.0 mm
LC-03-20-T16	30 cm	5.0 mm



with Mini Threaded Fitting

Item Code	Size	Diameter
LC-03-20-MT1	5 cm	2.0 mm
LC-03-20-MT2	15 cm	2.0 mm
LC-03-20-MT3	25 cm	2.0 mm
LC-03-20-MT4	30 cm	2.0 mm
LC-03-20-MT5	5 cm	3.0 mm
LC-03-20-MT6	15 cm	3.0 mm
LC-03-20-MT7	25 cm	3.0 mm
LC-03-20-MT8	30 cm	3.0 mm
LC-03-20-MT9	5 cm	4.0 mm
LC-03-20-MT10	15 cm	4.0 mm
LC-03-20-MT11	25 cm	4.0 mm
LC-03-20-MT12	30 cm	4.0 mm
LC-03-20-MT13	5 cm	5.0 mm
LC-03-20-MT14	15 cm	5.0 mm
LC-03-20-MT15	25 cm	5.0 mm
LC-03-20-MT16	30 cm	5.0 mm



Mercedes Liposuction Cannula, Three Lateral Holes



with Luer Lock Connector

Item Code	Size	Diameter
LC-01-21-L1	15 cm	3.0 mm
LC-01-21-L2	25 cm	3.0 mm
LC-01-21-L3	15 cm	4.0 mm
LC-01-21-L4	25 cm	4.0 mm



with Super Handle

Item Code	Size	Diameter
LC-02-21-SH1	15 cm	3.0 mm
LC-02-21-SH2	25 cm	3.0 mm
LC-02-21-SH3	15 cm	4.0 mm
LC-02-21-SH4	25 cm	4.0 mm



with Special Luer Lock Connector

Item Code	Size	Diameter
LC-01-21-S1	15 cm	3.0 mm
LC-01-21-S2	25 cm	3.0 mm
LC-01-21-S3	15 cm	4.0 mm
LC-01-21-S4	25 cm	4.0 mm



with Threaded Fitting

Item Code	Size	Diameter
LC-03-21-T1	15 cm	3.0 mm
LC-03-21-T2	25 cm	3.0 mm
LC-03-21-T3	15 cm	4.0 mm
LC-03-21-T4	25 cm	4.0 mm



with Mini Threaded Fitting

Item Code	Size	Diameter
LC-03-21-MT1	15 cm	3.0 mm
LC-03-21-MT2	25 cm	3.0 mm
LC-03-21-MT3	15 cm	4.0 mm
LC-03-21-MT4	25 cm	4.0 mm

Liposuction Cannulas



Kotzur Liposuction Cannula, 9 holes, for more effective and gentle suction in areas with much connected tissue as in case of Gynecomasty



with Luer Lock Connector

Item Code	Size	Diameter
LC-01-22-L1	30 cm	3.0 mm



with Super Handle

Item Code	Size	Diameter
LC-02-22-SH1	30 cm	3.0 mm



with Special Luer Lock Connector

Item Code	Size	Diameter
LC-01-22-S1	30 cm	3.0 mm



with Threaded Fitting

Item Code	Size	Diameter
LC-03-22-T1	30 cm	3.0 mm



with Mini Threaded Fitting

Item Code	Size	Diameter
LC-03-22-MT1	30 cm	3.0 mm



Liposuction Cannula, one central hole



with Luer Lock Connector

Item Code	Size	Diameter
LC-01-23-L1	5 cm	1.7 mm
LC-01-23-L2	15 cm	1.7 mm
LC-01-23-L3	5 cm	2.0 mm
LC-01-23-L4	15 cm	2.0 mm
LC-01-23-L5	5 cm	3.0 mm
LC-01-23-L6	15 cm	3.0 mm



with Special Luer Lock Connector

Item Code	Size	Diameter
LC-01-23-S1	5 cm	1.7 mm
LC-01-23-S2	15 cm	1.7 mm
LC-01-23-S3	5 cm	2.0 mm
LC-01-23-S4	15 cm	2.0 mm
LC-01-23-S5	5 cm	3.0 mm
LC-01-23-S6	15 cm	3.0 mm



with Threaded Fitting

Item Code	Size	Diameter
LC-03-23-T1	5 cm	1.7 mm
LC-03-23-T2	15 cm	1.7 mm
LC-03-23-T3	5 cm	2.0 mm
LC-03-23-T4	15 cm	2.0 mm
LC-03-23-T5	5 cm	3.0 mm
LC-03-23-T6	15 cm	3.0 mm



with Mini Threaded Fitting

Item Code	Size	Diameter
LC-03-23-MT1	5 cm	1.7 mm
LC-03-23-MT2	15 cm	1.7 mm
LC-03-23-MT3	5 cm	2.0 mm
LC-03-23-MT4	15 cm	2.0 mm
LC-03-23-MT5	5 cm	3.0 mm
LC-03-23-MT6	15 cm	3.0 mm



with Super Handle

Item Code	Size	Diameter
LC-02-23-SH1	5 cm	1.7 mm
LC-02-23-SH2	15 cm	1.7 mm
LC-02-23-SH3	5 cm	2.0 mm
LC-02-23-SH4	15 cm	2.0 mm
LC-02-23-SH5	5 cm	3.0 mm
LC-02-23-SH6	15 cm	3.0 mm

Liposuction Cannulas



Liposuction Cannulas, 8 Holes, Holes Dia 1.0mm



with Luer Lock Connector

Item Code	Size	Diameter
LC-01-24-L1	10 cm	1.5 mm
LC-01-24-L2	15 cm	1.5 mm
LC-01-24-L3	10 cm	2.0 mm
LC-01-24-L4	15 cm	2.0 mm



with Threaded Fitting

Item Code	Size	Diameter
LC-03-24-T1	10 cm	1.5 mm
LC-03-24-T2	15 cm	1.5 mm
LC-03-24-T3	10 cm	2.0 mm
LC-03-24-T4	15 cm	2.0 mm



with Special Luer Lock Connector

Item Code	Size	Diameter
LC-01-24-S1	10 cm	1.5 mm
LC-01-24-S2	15 cm	1.5 mm
LC-01-24-S3	10 cm	2.0 mm
LC-01-24-S4	15 cm	2.0 mm



with Mini Threaded Fitting

Item Code	Size	Diameter
LC-03-24-MT1	10 cm	1.5 mm
LC-03-24-MT2	15 cm	1.5 mm
LC-03-24-MT3	10 cm	2.0 mm
LC-03-24-MT4	15 cm	2.0 mm



with Super Handle

Item Code	Size	Diameter
LC-02-24-SH1	10 cm	1.5 mm
LC-02-24-SH2	15 cm	1.5 mm
LC-02-24-SH3	10 cm	2.0 mm
LC-02-24-SH4	15 cm	2.0 mm



Entener Liposuction Cannula



with Luer Lock Connector

Item Code	Size	Diameter	Holes
LC-01-25-L1	15 cm	2.0 mm	18
LC-01-25-L2	20 cm	2.0 mm	18
LC-01-25-L3	25 cm	2.0 mm	18
LC-01-25-L4	30 cm	2.0 mm	18
LC-01-25-L5	15 cm	2.0 mm	22
LC-01-25-L6	20 cm	2.0 mm	22
LC-01-25-L7	25 cm	2.0 mm	22
LC-01-25-L8	30 cm	2.0 mm	22
LC-01-25-L9	15 cm	2.0 mm	26
LC-01-25-L10	20 cm	2.0 mm	26
LC-01-25-L11	25 cm	2.0 mm	26
LC-01-25-L12	30 cm	2.0 mm	26
LC-01-25-L13	15 cm	2.0 mm	30
LC-01-25-L14	20 cm	2.0 mm	30
LC-01-25-L15	25 cm	2.0 mm	30
LC-01-25-L16	30 cm	2.0 mm	30
LC-01-25-L17	15 cm	2.5 mm	18
LC-01-25-L18	20 cm	2.5 mm	18
LC-01-25-L19	25 cm	2.5 mm	18
LC-01-25-L20	30 cm	2.5 mm	18
LC-01-25-L21	15 cm	2.5 mm	22
LC-01-25-L22	20 cm	2.5 mm	22
LC-01-25-L23	25 cm	2.5 mm	22
LC-01-25-L24	30 cm	2.5 mm	22
LC-01-25-L25	15 cm	2.5 mm	26
LC-01-25-L26	20 cm	2.5 mm	26
LC-01-25-L27	25 cm	2.5 mm	26
LC-01-25-L28	30 cm	2.5 mm	26
LC-01-25-L29	15 cm	2.5 mm	30
LC-01-25-L30	20 cm	2.5 mm	30
LC-01-25-L31	25 cm	2.5 mm	30
LC-01-25-L32	30 cm	2.5 mm	30

Item Code	Size	Diameter	Holes
LC-01-25-L33	15 cm	3.0 mm	18
LC-01-25-L34	20 cm	3.0 mm	18
LC-01-25-L35	25 cm	3.0 mm	18
LC-01-25-L36	30 cm	3.0 mm	18
LC-01-25-L37	15 cm	3.0 mm	22
LC-01-25-L38	20 cm	3.0 mm	22
LC-01-25-L39	25 cm	3.0 mm	22
LC-01-25-L40	30 cm	3.0 mm	22
LC-01-25-L41	15 cm	3.0 mm	26
LC-01-25-L42	20 cm	3.0 mm	26
LC-01-25-L43	25 cm	3.0 mm	26
LC-01-25-L44	30 cm	3.0 mm	26
LC-01-25-L45	15 cm	3.0 mm	30
LC-01-25-L46	20 cm	3.0 mm	30
LC-01-25-L47	25 cm	3.0 mm	30
LC-01-25-L48	30 cm	3.0 mm	30
LC-01-25-L49	15 cm	4.0 mm	18
LC-01-25-L50	20 cm	4.0 mm	18
LC-01-25-L51	25 cm	4.0 mm	18
LC-01-25-L52	30 cm	4.0 mm	18
LC-01-25-L53	15 cm	4.0 mm	22
LC-01-25-L54	20 cm	4.0 mm	22
LC-01-25-L55	25 cm	4.0 mm	22
LC-01-25-L56	30 cm	4.0 mm	22
LC-01-25-L57	15 cm	4.0 mm	26
LC-01-25-L58	20 cm	4.0 mm	26
LC-01-25-L59	25 cm	4.0 mm	26
LC-01-25-L60	30 cm	4.0 mm	26
LC-01-25-L61	15 cm	4.0 mm	30
LC-01-25-L62	20 cm	4.0 mm	30
LC-01-25-L63	25 cm	4.0 mm	30
LC-01-25-L64	30 cm	4.0 mm	30



Entener Liposuction Cannula



with Special Luer Lock Connector

Item Code	Size	Diameter	Holes
LC-01-25-S1	15 cm	2.0 mm	18
LC-01-25-S2	20 cm	2.0 mm	18
LC-01-25-S3	25 cm	2.0 mm	18
LC-01-25-S4	30 cm	2.0 mm	18
LC-01-25-S5	15 cm	2.0 mm	22
LC-01-25-S6	20 cm	2.0 mm	22
LC-01-25-S7	25 cm	2.0 mm	22
LC-01-25-S8	30 cm	2.0 mm	22
LC-01-25-S9	15 cm	2.0 mm	26
LC-01-25-S10	20 cm	2.0 mm	26
LC-01-25-S11	25 cm	2.0 mm	26
LC-01-25-S12	30 cm	2.0 mm	26
LC-01-25-S13	15 cm	2.0 mm	30
LC-01-25-S14	20 cm	2.0 mm	30
LC-01-25-S15	25 cm	2.0 mm	30
LC-01-25-S16	30 cm	2.0 mm	30

LC-01-25-S17	15 cm	2.5 mm	18
LC-01-25-S18	20 cm	2.5 mm	18
LC-01-25-S19	25 cm	2.5 mm	18
LC-01-25-S20	30 cm	2.5 mm	18
LC-01-25-S21	15 cm	2.5 mm	22
LC-01-25-S22	20 cm	2.5 mm	22
LC-01-25-S23	25 cm	2.5 mm	22
LC-01-25-S24	30 cm	2.5 mm	22
LC-01-25-S25	15 cm	2.5 mm	26
LC-01-25-S26	20 cm	2.5 mm	26
LC-01-25-S27	25 cm	2.5 mm	26
LC-01-25-S28	30 cm	2.5 mm	26
LC-01-25-S29	15 cm	2.5 mm	30
LC-01-25-S30	20 cm	2.5 mm	30
LC-01-25-S31	25 cm	2.5 mm	30
LC-01-25-S32	30 cm	2.5 mm	30

Item Code	Size	Diameter	Holes
LC-01-25-S33	15 cm	3.0 mm	18
LC-01-25-S34	20 cm	3.0 mm	18
LC-01-25-S35	25 cm	3.0 mm	18
LC-01-25-S36	30 cm	3.0 mm	18
LC-01-25-S37	15 cm	3.0 mm	22
LC-01-25-S38	20 cm	3.0 mm	22
LC-01-25-S39	25 cm	3.0 mm	22
LC-01-25-S40	30 cm	3.0 mm	22
LC-01-25-S41	15 cm	3.0 mm	26
LC-01-25-S42	20 cm	3.0 mm	26
LC-01-25-S43	25 cm	3.0 mm	26
LC-01-25-S44	30 cm	3.0 mm	26
LC-01-25-S45	15 cm	3.0 mm	30
LC-01-25-S46	20 cm	3.0 mm	30
LC-01-25-S47	25 cm	3.0 mm	30
LC-01-25-S48	30 cm	3.0 mm	30

LC-01-25-S49	15 cm	4.0 mm	18
LC-01-25-S50	20 cm	4.0 mm	18
LC-01-25-S51	25 cm	4.0 mm	18
LC-01-25-S52	30 cm	4.0 mm	18
LC-01-25-S53	15 cm	4.0 mm	22
LC-01-25-S54	20 cm	4.0 mm	22
LC-01-25-S55	25 cm	4.0 mm	22
LC-01-25-S56	30 cm	4.0 mm	22
LC-01-25-S57	15 cm	4.0 mm	26
LC-01-25-S58	20 cm	4.0 mm	26
LC-01-25-S59	25 cm	4.0 mm	26
LC-01-25-S60	30 cm	4.0 mm	26
LC-01-25-S61	15 cm	4.0 mm	30
LC-01-25-S62	20 cm	4.0 mm	30
LC-01-25-S63	25 cm	4.0 mm	30
LC-01-25-S64	30 cm	4.0 mm	30



Entener Liposuction Cannula



with Super Handle

Item Code	Size	Diameter	Holes
LC-02-25-SH1	15 cm	2.0 mm	18
LC-02-25-SH2	20 cm	2.0 mm	18
LC-02-25-SH3	25 cm	2.0 mm	18
LC-02-25-SH4	30 cm	2.0 mm	18
LC-02-25-SH5	15 cm	2.0 mm	22
LC-02-25-SH6	20 cm	2.0 mm	22
LC-02-25-SH7	25 cm	2.0 mm	22
LC-02-25-SH8	30 cm	2.0 mm	22
LC-02-25-SH9	15 cm	2.0 mm	26
LC-02-25-SH10	20 cm	2.0 mm	26
LC-02-25-SH11	25 cm	2.0 mm	26
LC-02-25-SH12	30 cm	2.0 mm	26
LC-02-25-SH13	15 cm	2.0 mm	30
LC-02-25-SH14	20 cm	2.0 mm	30
LC-02-25-SH15	25 cm	2.0 mm	30
LC-02-25-SH16	30 cm	2.0 mm	30

LC-02-25-SH17	15 cm	2.5 mm	18
LC-02-25-SH18	20 cm	2.5 mm	18
LC-02-25-SH19	25 cm	2.5 mm	18
LC-02-25-SH20	30 cm	2.5 mm	18
LC-02-25-SH21	15 cm	2.5 mm	22
LC-02-25-SH22	20 cm	2.5 mm	22
LC-02-25-SH23	25 cm	2.5 mm	22
LC-02-25-SH24	30 cm	2.5 mm	22
LC-02-25-SH25	15 cm	2.5 mm	26
LC-02-25-SH26	20 cm	2.5 mm	26
LC-02-25-SH27	25 cm	2.5 mm	26
LC-02-25-SH28	30 cm	2.5 mm	26
LC-02-25-SH29	15 cm	2.5 mm	30
LC-02-25-SH30	20 cm	2.5 mm	30
LC-02-25-SH31	25 cm	2.5 mm	30
LC-02-25-SH32	30 cm	2.5 mm	30

Item Code	Size	Diameter	Holes
LC-02-25-S33	15 cm	2.0 mm	18
LC-02-25-S34	20 cm	2.0 mm	18
LC-02-25-S35	25 cm	2.0 mm	18
LC-02-25-S36	30 cm	2.0 mm	18
LC-02-25-S37	15 cm	2.0 mm	22
LC-02-25-S38	20 cm	2.0 mm	22
LC-02-25-S39	25 cm	2.0 mm	22
LC-02-25-S40	30 cm	2.0 mm	22
LC-02-25-S41	15 cm	2.0 mm	26
LC-02-25-S42	20 cm	2.0 mm	26
LC-02-25-S43	25 cm	2.0 mm	26
LC-02-25-S44	30 cm	2.0 mm	26
LC-02-25-S45	15 cm	2.0 mm	30
LC-02-25-S46	20 cm	2.0 mm	30
LC-02-25-S47	25 cm	2.0 mm	30
LC-02-25-S48	30 cm	2.0 mm	30

LC-02-25-S49	15 cm	2.5 mm	18
LC-02-25-S50	20 cm	2.5 mm	18
LC-02-25-S51	25 cm	2.5 mm	18
LC-02-25-S52	30 cm	2.5 mm	18
LC-02-25-S53	15 cm	2.5 mm	22
LC-02-25-S54	20 cm	2.5 mm	22
LC-02-25-S55	25 cm	2.5 mm	22
LC-02-25-S56	30 cm	2.5 mm	22
LC-02-25-S57	15 cm	2.5 mm	26
LC-02-25-S58	20 cm	2.5 mm	26
LC-02-25-S59	25 cm	2.5 mm	26
LC-02-25-S60	30 cm	2.5 mm	26
LC-02-25-S61	15 cm	2.5 mm	30
LC-02-25-S62	20 cm	2.5 mm	30
LC-02-25-S63	25 cm	2.5 mm	30
LC-02-25-S64	30 cm	2.5 mm	30



Entener Liposuction Cannula



with Threaded Fitting

Item Code	Size	Diameter	Holes
LC-03-25-T1	15 cm	2.0 mm	18
LC-03-25-T2	20 cm	2.0 mm	18
LC-03-25-T3	25 cm	2.0 mm	18
LC-03-25-T4	30 cm	2.0 mm	18
LC-03-25-T5	15 cm	2.0 mm	22
LC-03-25-T6	20 cm	2.0 mm	22
LC-03-25-T7	25 cm	2.0 mm	22
LC-03-25-T8	30 cm	2.0 mm	22
LC-03-25-T9	15 cm	2.0 mm	26
LC-03-25-T10	20 cm	2.0 mm	26
LC-03-25-T11	25 cm	2.0 mm	26
LC-03-25-T12	30 cm	2.0 mm	26
LC-03-25-T13	15 cm	2.0 mm	30
LC-03-25-T14	20 cm	2.0 mm	30
LC-03-25-T15	25 cm	2.0 mm	30
LC-03-25-T16	30 cm	2.0 mm	30
LC-03-25-T17	15 cm	2.5 mm	18
LC-03-25-T18	20 cm	2.5 mm	18
LC-03-25-T19	25 cm	2.5 mm	18
LC-03-25-T20	30 cm	2.5 mm	18
LC-03-25-T21	15 cm	2.5 mm	22
LC-03-25-T22	20 cm	2.5 mm	22
LC-03-25-T23	25 cm	2.5 mm	22
LC-03-25-T24	30 cm	2.5 mm	22
LC-03-25-T25	15 cm	2.5 mm	26
LC-03-25-T26	20 cm	2.5 mm	26
LC-03-25-T27	25 cm	2.5 mm	26
LC-03-25-T28	30 cm	2.5 mm	26
LC-03-25-T29	15 cm	2.5 mm	30
LC-03-25-T30	20 cm	2.5 mm	30
LC-03-25-T31	25 cm	2.5 mm	30
LC-03-25-T32	30 cm	2.5 mm	30

Item Code	Size	Diameter	Holes
LC-03-25-T33	15 cm	2.0 mm	18
LC-03-25-T34	20 cm	2.0 mm	18
LC-03-25-T35	25 cm	2.0 mm	18
LC-03-25-T36	30 cm	2.0 mm	18
LC-03-25-T37	15 cm	2.0 mm	22
LC-03-25-T38	20 cm	2.0 mm	22
LC-03-25-T39	25 cm	2.0 mm	22
LC-03-25-T40	30 cm	2.0 mm	22
LC-03-25-T41	15 cm	2.0 mm	26
LC-03-25-T42	20 cm	2.0 mm	26
LC-03-25-T43	25 cm	2.0 mm	26
LC-03-25-T44	30 cm	2.0 mm	26
LC-03-25-T45	15 cm	2.0 mm	30
LC-03-25-T46	20 cm	2.0 mm	30
LC-03-25-T47	25 cm	2.0 mm	30
LC-03-25-T48	30 cm	2.0 mm	30
LC-03-25-T49	15 cm	2.5 mm	18
LC-03-25-T50	20 cm	2.5 mm	18
LC-03-25-T51	25 cm	2.5 mm	18
LC-03-25-T52	30 cm	2.5 mm	18
LC-03-25-T53	15 cm	2.5 mm	22
LC-03-25-T54	20 cm	2.5 mm	22
LC-03-25-T55	25 cm	2.5 mm	22
LC-03-25-T56	30 cm	2.5 mm	22
LC-03-25-T57	15 cm	2.5 mm	26
LC-03-25-T58	20 cm	2.5 mm	26
LC-03-25-T59	25 cm	2.5 mm	26
LC-03-25-T60	30 cm	2.5 mm	26
LC-03-25-T61	15 cm	2.5 mm	30
LC-03-25-T62	20 cm	2.5 mm	30
LC-03-25-T63	25 cm	2.5 mm	30
LC-03-25-T64	30 cm	2.5 mm	30



Entener Liposuction Cannula



with Mini Threaded Fitting

Item Code	Size	Diameter	Holes
LC-03-25-MT1	15 cm	2.0 mm	18
LC-03-25-MT2	20 cm	2.0 mm	18
LC-03-25-MT3	25 cm	2.0 mm	18
LC-03-25-MT4	30 cm	2.0 mm	18
LC-03-25-MT5	15 cm	2.0 mm	22
LC-03-25-MT6	20 cm	2.0 mm	22
LC-03-25-MT7	25 cm	2.0 mm	22
LC-03-25-MT8	30 cm	2.0 mm	22
LC-03-25-MT9	15 cm	2.0 mm	26
LC-03-25-MT10	20 cm	2.0 mm	26
LC-03-25-MT11	25 cm	2.0 mm	26
LC-03-25-MT12	30 cm	2.0 mm	26
LC-03-25-MT13	15 cm	2.0 mm	30
LC-03-25-MT14	20 cm	2.0 mm	30
LC-03-25-MT15	25 cm	2.0 mm	30
LC-03-25-MT16	30 cm	2.0 mm	30
LC-03-25-MT17	15 cm	2.5 mm	18
LC-03-25-MT18	20 cm	2.5 mm	18
LC-03-25-MT19	25 cm	2.5 mm	18
LC-03-25-MT20	30 cm	2.5 mm	18
LC-03-25-MT21	15 cm	2.5 mm	22
LC-03-25-MT22	20 cm	2.5 mm	22
LC-03-25-MT23	25 cm	2.5 mm	22
LC-03-25-MT24	30 cm	2.5 mm	22
LC-03-25-MT25	15 cm	2.5 mm	26
LC-03-25-MT26	20 cm	2.5 mm	26
LC-03-25-MT27	25 cm	2.5 mm	26
LC-03-25-MT28	30 cm	2.5 mm	26
LC-03-25-MT29	15 cm	2.5 mm	30
LC-03-25-MT30	20 cm	2.5 mm	30
LC-03-25-MT31	25 cm	2.5 mm	30
LC-03-25-MT32	30 cm	2.5 mm	30

Item Code	Size	Diameter	Holes
LC-03-25-MT33	15 cm	2.0 mm	18
LC-03-25-MT34	20 cm	2.0 mm	18
LC-03-25-MT35	25 cm	2.0 mm	18
LC-03-25-MT36	30 cm	2.0 mm	18
LC-03-25-MT37	15 cm	2.0 mm	22
LC-03-25-MT38	20 cm	2.0 mm	22
LC-03-25-MT39	25 cm	2.0 mm	22
LC-03-25-MT40	30 cm	2.0 mm	22
LC-03-25-MT41	15 cm	2.0 mm	26
LC-03-25-MT42	20 cm	2.0 mm	26
LC-03-25-MT43	25 cm	2.0 mm	26
LC-03-25-MT44	30 cm	2.0 mm	26
LC-03-25-MT45	15 cm	2.0 mm	30
LC-03-25-MT46	20 cm	2.0 mm	30
LC-03-25-MT47	25 cm	2.0 mm	30
LC-03-25-MT48	30 cm	2.0 mm	30
LC-03-25-MT49	15 cm	2.5 mm	18
LC-03-25-MT50	20 cm	2.5 mm	18
LC-03-25-MT51	25 cm	2.5 mm	18
LC-03-25-MT52	30 cm	2.5 mm	18
LC-03-25-MT53	15 cm	2.5 mm	22
LC-03-25-MT54	20 cm	2.5 mm	22
LC-03-25-MT55	25 cm	2.5 mm	22
LC-03-25-MT56	30 cm	2.5 mm	22
LC-03-25-MT57	15 cm	2.5 mm	26
LC-03-25-MT58	20 cm	2.5 mm	26
LC-03-25-MT59	25 cm	2.5 mm	26
LC-03-25-MT60	30 cm	2.5 mm	26
LC-03-25-MT61	15 cm	2.5 mm	30
LC-03-25-MT62	20 cm	2.5 mm	30
LC-03-25-MT63	25 cm	2.5 mm	30
LC-03-25-MT64	30 cm	2.5 mm	30



Entener Liposuction Cannula (Bayonet Shape)

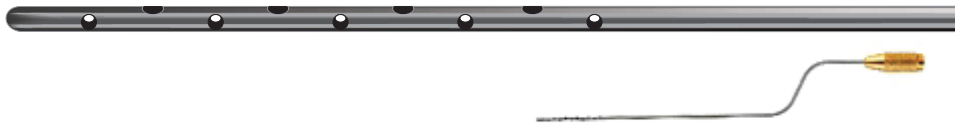

with Luer Lock Connector

Item Code	Size	Diameter	Holes
LC-01-26-L1	20 cm	3.0 mm	22
LC-01-26-L2	30 cm	3.0 mm	22
LC-01-26-L3	20 cm	3.0 mm	30
LC-01-26-L4	30 cm	3.0 mm	30
LC-01-26-L5	20 cm	4.0 mm	22
LC-01-26-L6	30 cm	4.0 mm	22
LC-01-26-L7	20 cm	4.0 mm	30
LC-01-26-L8	30 cm	4.0 mm	30



with Special Luer Lock Connector

Item Code	Size	Diameter	Holes
LC-01-26-S1	20 cm	3.0 mm	22
LC-01-26-S2	30 cm	3.0 mm	22
LC-01-26-S3	20 cm	3.0 mm	30
LC-01-26-S4	30 cm	3.0 mm	30
LC-01-26-S5	20 cm	4.0 mm	22
LC-01-26-S6	30 cm	4.0 mm	22
LC-01-26-S7	20 cm	4.0 mm	30
LC-01-26-S8	30 cm	4.0 mm	30



with Super Handle

Item Code	Size	Diameter	Holes
LC-02-26-SH1	20 cm	3.0 mm	22
LC-02-26-SH2	30 cm	3.0 mm	22
LC-02-26-SH3	20 cm	3.0 mm	30
LC-02-26-SH4	30 cm	3.0 mm	30
LC-02-26-SH5	20 cm	4.0 mm	22
LC-02-26-SH6	30 cm	4.0 mm	22
LC-02-26-SH7	20 cm	4.0 mm	30
LC-02-26-SH8	30 cm	4.0 mm	30



with Threaded Fitting

Item Code	Size	Diameter	Holes
LC-03-26-T1	20 cm	3.0 mm	22
LC-03-26-T2	30 cm	3.0 mm	22
LC-03-26-T3	20 cm	3.0 mm	30
LC-03-26-T4	30 cm	3.0 mm	30
LC-03-26-T5	20 cm	4.0 mm	22
LC-03-26-T6	30 cm	4.0 mm	22
LC-03-26-T7	20 cm	4.0 mm	30
LC-03-26-T8	30 cm	4.0 mm	30



Entener Liposuction Cannula (Bayonet Shape)



with Mini Threaded Fitting

Item Code	Size	Diameter	Holes
LC-03-26-MT1	20 cm	3.0 mm	22
LC-03-26-MT2	30 cm	3.0 mm	22
LC-03-26-MT3	20 cm	3.0 mm	30
LC-03-26-MT4	30 cm	3.0 mm	30
LC-03-26-MT5	20 cm	4.0 mm	22
LC-03-26-MT6	30 cm	4.0 mm	22
LC-03-26-MT7	20 cm	4.0 mm	30
LC-03-26-MT8	30 cm	4.0 mm	30

ZIMAIZ
INTERNATIONAL

Liposuction Cannulas



Infiltration & Liposuction Cannulas, Ø 1.5mm each



with Luer Lock Connector

Item Code	Size	Diameter	Holes
LC-01-27-L1	20 cm	3.0 mm	22



with Threaded Fitting

Item Code	Size	Diameter	Holes
LC-03-27-T1	20 cm	3.0 mm	22



with Special Luer Lock Connector

Item Code	Size	Diameter	Holes
LC-01-27-S1	20 cm	3.0 mm	22



with Mini Threaded Fitting

Item Code	Size	Diameter	Holes
LC-03-27-MT1	20 cm	3.0 mm	22



with Super Handle

Item Code	Size	Diameter	Holes
LC-02-27-SH1	20 cm	3.0 mm	22



Liposuction Cannulas

Infiltration & Liposuction Cannulas, Ø 1.0mm



with Luer Lock Connector

Item Code	Size	Diameter	Holes
LC-01-28-L1	25 cm	2.0 mm	10
LC-01-28-L2	25 cm	3.0 mm	10



with Threaded Fitting

Item Code	Size	Diameter	Holes
LC-03-28-T1	25 cm	2.0 mm	10
LC-03-28-T2	25 cm	3.0 mm	10



with Special Luer Lock Connector

Item Code	Size	Diameter	Holes
LC-01-28-S1	25 cm	2.0 mm	10
LC-01-28-S2	25 cm	3.0 mm	10



with Mini Threaded Fitting

Item Code	Size	Diameter	Holes
LC-03-28-MT1	25 cm	2.0 mm	10
LC-03-28-MT2	25 cm	3.0 mm	10



with Super Handle

Item Code	Size	Diameter	Holes
LC-02-28-SH1	25 cm	2.0 mm	10
LC-02-28-SH2	25 cm	3.0 mm	10



Basket Liposuction Cannulas



with Luer Lock Connector

Item Code	Size	Diameter
LC-01-29-L1	20 cm	3.0 mm
LC-01-29-L2	25 cm	3.0 mm
LC-01-29-L3	30 cm	3.0 mm
LC-01-29-L4	35 cm	3.0 mm

LC-01-29-L5	20 cm	4.0 mm
LC-01-29-L6	25 cm	4.0 mm
LC-01-29-L7	30 cm	4.0 mm
LC-01-29-L8	35 cm	4.0 mm



with Special Luer Lock Connector

Item Code	Size	Diameter
LC-01-29-S1	20 cm	3.0 mm
LC-01-29-S2	25 cm	3.0 mm
LC-01-29-S3	30 cm	3.0 mm
LC-01-29-S4	35 cm	3.0 mm

LC-01-29-S5	20 cm	4.0 mm
LC-01-29-S6	25 cm	4.0 mm
LC-01-29-S7	30 cm	4.0 mm
LC-01-29-S8	35 cm	4.0 mm



with Super Handle

Item Code	Size	Diameter
LC-02-29-SH1	20 cm	3.0 mm
LC-02-29-SH2	25 cm	3.0 mm
LC-02-29-SH3	30 cm	3.0 mm
LC-02-29-SH4	35 cm	3.0 mm

LC-02-29-SH5	20 cm	4.0 mm
LC-02-29-SH6	25 cm	4.0 mm
LC-02-29-SH7	30 cm	4.0 mm
LC-02-29-SH8	35 cm	4.0 mm

LC-02-29-SH9	20 cm	5.0 mm
LC-02-29-SH10	25 cm	5.0 mm
LC-02-29-SH11	30 cm	5.0 mm
LC-02-29-SH12	35 cm	5.0 mm



with Threaded Fitting

Item Code	Size	Diameter
LC-03-29-T1	20 cm	3.0 mm
LC-03-29-T2	25 cm	3.0 mm
LC-03-29-T3	30 cm	3.0 mm
LC-03-29-T4	35 cm	3.0 mm

LC-03-29-T5	20 cm	4.0 mm
LC-03-29-T6	25 cm	4.0 mm
LC-03-29-T7	30 cm	4.0 mm
LC-03-29-T8	35 cm	4.0 mm

LC-03-29-T9	20 cm	5.0 mm
LC-03-29-T10	25 cm	5.0 mm
LC-03-29-T11	30 cm	5.0 mm
LC-03-29-T12	35 cm	5.0 mm



Basket Liposuction Cannulas



with Mini Threaded Fitting

Item Code	Size	Diameter
LC-03-29-T1	20 cm	3.0 mm
LC-03-29-T2	25 cm	3.0 mm
LC-03-29-T3	30 cm	3.0 mm
LC-03-29-T4	35 cm	3.0 mm
LC-03-29-T5	20 cm	4.0 mm
LC-03-29-T6	25 cm	4.0 mm
LC-03-29-T7	30 cm	4.0 mm
LC-03-29-T8	35 cm	4.0 mm
LC-03-29-T9	20 cm	5.0 mm
LC-03-29-T10	25 cm	5.0 mm
LC-03-29-T11	30 cm	5.0 mm
LC-03-29-T12	35 cm	5.0 mm

ZIMAIZ
INTERNATIONAL



Spatula Cannulas



with Luer Lock Connector

Item Code	Size	Diameter
LC-01-30-L1	20 cm	3.0 mm
LC-01-30-L2	25 cm	3.0 mm
LC-01-30-L3	30 cm	3.0 mm

LC-01-30-L4	20 cm	4.0 mm
LC-01-30-L5	25 cm	4.0 mm
LC-01-30-L6	30 cm	4.0 mm



with Special Luer Lock Connector

Item Code	Size	Diameter
LC-01-30-S1	20 cm	3.0 mm
LC-01-30-S2	25 cm	3.0 mm
LC-01-30-S3	30 cm	3.0 mm

LC-01-30-S4	20 cm	4.0 mm
LC-01-30-S5	25 cm	4.0 mm
LC-01-30-S6	30 cm	4.0 mm



with Threaded Fitting

Item Code	Size	Diameter
LC-03-30-T1	20 cm	3.0 mm
LC-03-30-T2	25 cm	3.0 mm
LC-03-30-T3	30 cm	3.0 mm

LC-03-30-T4	20 cm	4.0 mm
LC-03-30-T5	25 cm	4.0 mm
LC-03-30-T6	30 cm	4.0 mm



with Mini Threaded Fitting

Item Code	Size	Diameter
LC-03-30-MT1	20 cm	3.0 mm
LC-03-30-MT2	25 cm	3.0 mm
LC-03-30-MT3	30 cm	3.0 mm

LC-03-30-MT4	20 cm	4.0 mm
LC-03-30-MT5	25 cm	4.0 mm
LC-03-30-MT6	30 cm	4.0 mm



with Super Handle

Item Code	Size	Diameter
LC-02-30-SH1	20 cm	3.0 mm
LC-02-30-SH2	25 cm	3.0 mm
LC-02-30-SH3	30 cm	3.0 mm

LC-02-30-SH4	20 cm	4.0 mm
LC-02-30-SH5	25 cm	4.0 mm
LC-02-30-SH6	30 cm	4.0 mm



Liposuction Cannulas Accessories



Item Code	Description
LCA-04-01-01	Liposuction Cannula Handle (Stainless Steel)
LCA-04-01-02	Liposuction Cannula Handle (Aluminium)



Item Code	Description
LCA-04-02-01	Liposuction Cannula Handle with Interrupting Hole (Stainless Steel)
LCA-04-02-02	Liposuction Cannula Handle with Interrupting Hole (Aluminium)



Item Code	Description
LCA-04-03-01	Interchange Adapter, 5 cm (Stainless Steel)
LCA-04-03-02	Interchange Adapter, 5 cm (Aluminium)



Item Code	Description
LCA-04-04	Syringe Holding Device (Aluminium)



Item Code	Description
LCA-04-05	Leur Lock Transfer Adapter

Liposuction Cannulas



Item Code	Description
LCA-04-06	Locks Set (10 Pieces) for Luer Lock Syringes, Aluminium



Item Code	Description
LCA-04-07	Fat Injection Gun fit on 10cc and 20cc Syringes



Item Code	Description
LCA-04-08-01	Aluminum Stop Lock for 10cc Syringe
LCA-04-08-02	Aluminum Stop Lock for 20cc Syringe
LCA-04-08-03	Aluminum Stop Lock for 50cc Syringe
LCA-04-08-04	Aluminum Stop Lock for 60cc Syringe



Liposuction Cannulas



Item Code	Description
LCA-04-10-01	Aspirator Luer Lock Handle
LCA-04-10-02	Aspirator Double ended Luer Lock Handle



Item Code	Description
LCA-04-11	Transfer Adaptor Luer to Luer 1.0 mm
LCA-04-12	Transfer Adaptor Luer to Luer 1.4 mm
LCA-04-13	Transfer Adaptor Luer to Luer 2.4 mm
LCA-04-14	Transfer Adaptor Luer to Luer 3.0 mm





Liposuction Cannulas Set



Item Code	Description
NI-LSS-01	Liposuction Cannula Set for Abdomen and Saddlebag With Threaded Fitting
Consisting of	Liposuction Cannula with threaded connector, 22-Holes, diameter 3.0 mm, working length 20cm
	Liposuction Cannula with threaded connector, 22-Holes, diameter 4.0 mm, working length 20cm
	Liposuction Cannula with threaded connector, 30-Holes, diameter 3.0 mm, working length 30cm
	Liposuction Cannula with threaded connector, 30-Holes, diameter 4.0 mm, working length 30cm
	Liposuction Cannula Handle
	Liposuction Cannula Handle with Interrupting Hole



Liposuction Cannulas Set



Item Code	Description
NI-LSS-05	Liposuction Cannula Set for Face with Luer Lock Fitting
Consisting of	Liposuction Cannula, with one central hole, diameter 1.7 mm, working length 5 cm
	Liposuction Cannula, with one central hole, diameter 1.7 mm, working length 15 cm
	Liposuction Cannula, 18-Holes, diameter 2.0 mm, working length 15 cm



Liposuction Cannulas Set

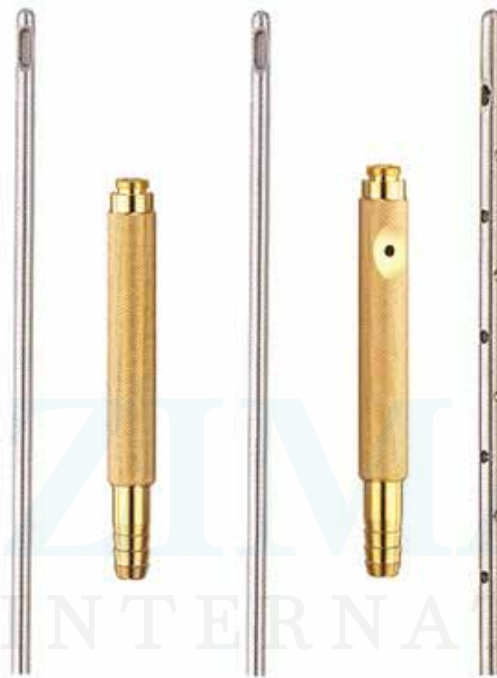

Item Code	Description
NI-LSS-06	Liposuction Cannula Set for Face with Threaded Fitting
Consisting of	Liposuction Cannula, with one central hole, diameter 1.7 mm, working length 5 cm
	Liposuction Cannula, with one central hole, diameter 1.7 mm, working length 15 cm
	Liposuction Cannula, 18-Holes, diameter 2.0 mm, working length 15 cm
	Liposuction Cannula Handle
	Liposuction Cannula Handle with Interrupting Hole



Liposuction Cannulas Set



Item Code	Description
NI-LSS-07	Liposuction Cannula Set for Neck
Consisting of	Liposuction Cannula with Luer-Lock, with one central hole, diameter 2.0 mm, working length 5cm
	Liposuction Cannula with Luer-Lock, with one central hole, diameter 3.0 mm, working length 5cm
	Liposuction Cannula with Luer-Lock, with one central hole, diameter 2.0 mm, working length 15cm
	Liposuction Cannula with Luer-Lock, with one central hole, diameter 3.0 mm, working length 15cm
	Liposuction Cannula with threaded connector, 18-Holes, diameter 3.0 mm, working length 15 cm
	Liposuction Cannula with threaded connector, Angled, 22-Holes, diameter 3.0 mm, working length 20 cm
	Liposuction Cannula with threaded connector, 8-Holes, diameter 2.0 mm, working length 15 cm
	Liposuction Cannula Handle
	Liposuction Cannula Handle with Interrupting Hole



Liposuction Cannulas Set



Item Code	Description
NI-LSS-10	Liposuction Cannula Set for Thie and Lower Leg with Threaded Fitting
Consisting of	Liposuction Cannula with threaded connector, byonet shape, 22-Holes, diameter 3.0 mm, working length 20 cm
	Liposuction Cannula with threaded connector, byonet shape, 22-Holes, diameter 4.0 mm, working length 20 cm
	Liposuction Cannula with threaded connector, byonet shape, 30-Holes, diameter 3.0 mm, working length 30 cm
	Liposuction Cannula with threaded connector, byonet shape, 30-Holes, diameter 4.0 mm, working length 30 cm
	Liposuction Cannula Handle
	Liposuction Cannula Handle with Interrupting Hole



Liposuction Cannulas Set



Item Code	Description
NI-LSS-12	Micro Fat Injection Cannulas Set
Consisting of	Open Port Injector Cannula, 1.2mm, 10cm, Luer Lock
	Multi Holes Harvester Cannula Model 2, 2.5mm, 20cm, Luer Lock
	Tumescent Infiltrator Cannula, 1.5mm, 12cm Luer Lock
	Micro Injector Cannula, 0.8mm, 4cm, Luer Lock
	Micro Injector Cannula, 1.0mm, 5cm, Luer Lock
	Holding Device
	Luer Lock Syringe Cap



ZIMAIZ
INTERNATIONAL