

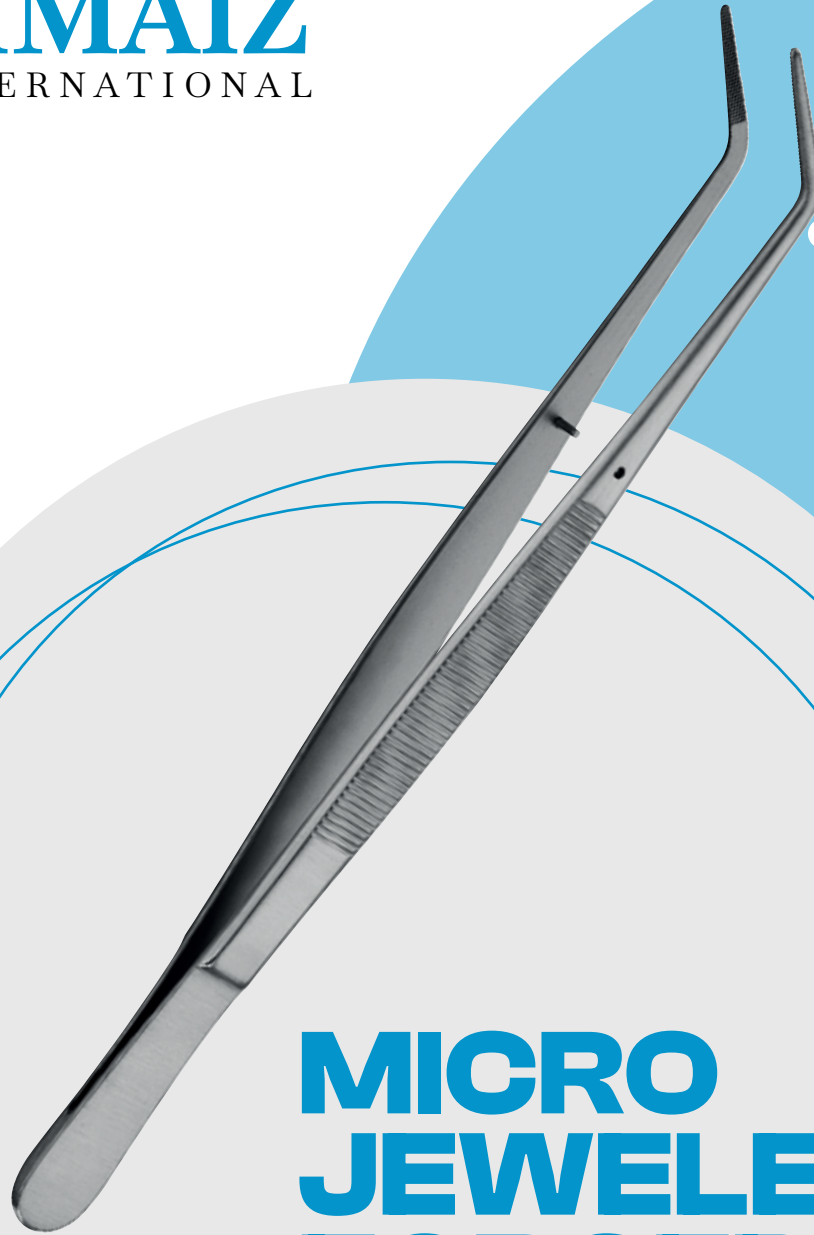

**ZIMAIZ**  
INTERNATIONAL



# **MICRO JEWELERS FORCEPS**

SURGICAL  
INSTRUMENTS  
CATALOGUE





## Pinzetten Forceps

Mikro-Uhrmacher Pinzetten	<i>Micro Jewelers Forceps</i>	FC 1
Mikro-Nahtpinzetten	<i>Micro Suture Forceps</i>	FC 2 - 3
Anatomische Mikro-Pinzetten	<i>Dissecting Micro Forceps</i>	FC 4 - 7
Mikro-Tumorfaßpinzetten	<i>Micro Tumor Grasping Forceps</i>	FC 8 - 9
Mikro-Pinzetten, Rundgriff	<i>Micro Forceps, Round Handle</i>	FC 10
Feine anatomische Pinzetten	<i>Delicate Dissecting Forceps</i>	FC 11 - 18
Anatomische Pinzetten	<i>Dissecting Forceps</i>	FC 19 - 21
Atraumatische Pinzetten	<i>Atraumatic Forceps</i>	FC 22
Ohrpinzetten	<i>Ear Dressing Forceps</i>	FC 23 - 24
Feine chirurgische Pinzetten	<i>Delicate Tissue Forceps</i>	FC 25 - 32
Chirurgische Pinzetten	<i>Tissue Forceps</i>	FC 33 - 36
Hautpinzetten	<i>Skin Forceps</i>	FC 37
Darm- und Lungenpinzetten	<i>Intestinal and Lung Forceps</i>	FC 38
Fasspinzetten	<i>Grasping Forceps</i>	FC 39
Splitterpinzetten	<i>Splinter Forceps</i>	FC 40
Splitterzangen	<i>Splinter Forceps</i>	FC 41
Cilienpinzetten	<i>Cilia Forceps</i>	FC 42

# Mikro-Uhrmacher-Pinzetten Micro Jewelers Forceps

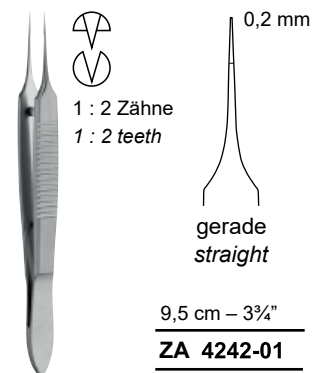
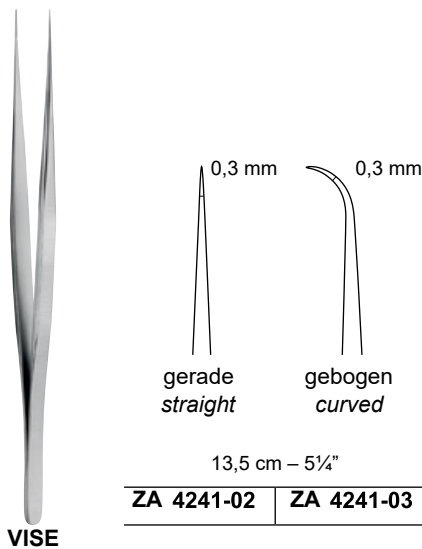
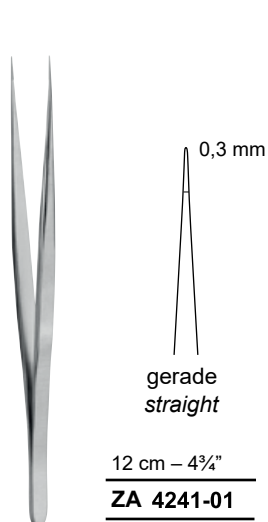
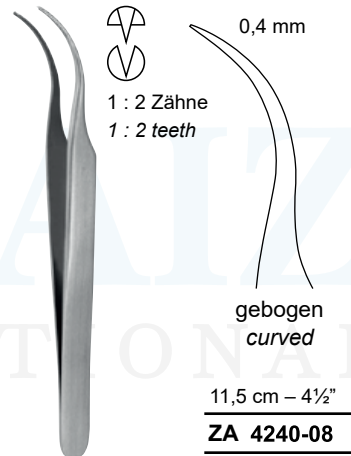
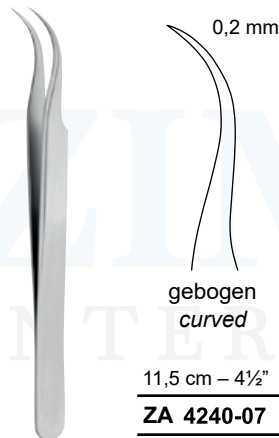
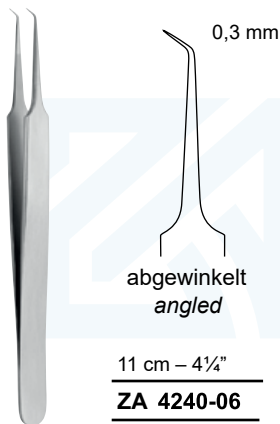
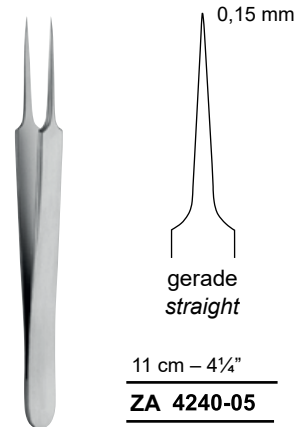
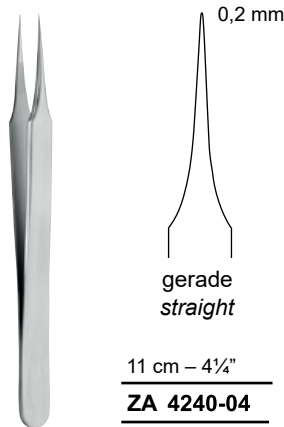
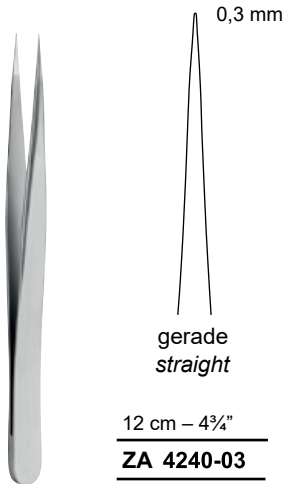



# Mikro-Nahtpinzetten Micro Suture Forceps

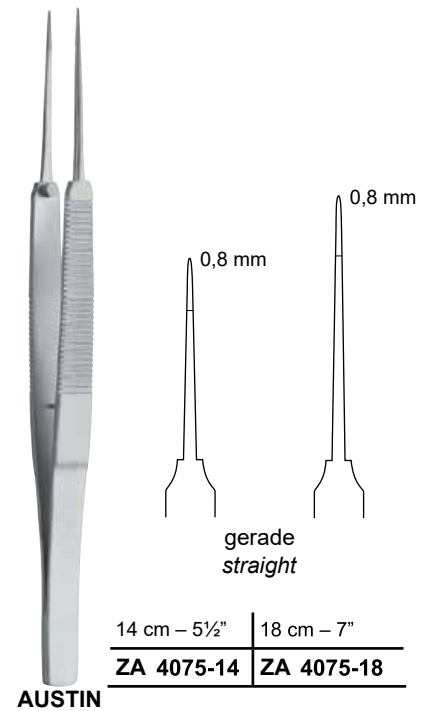
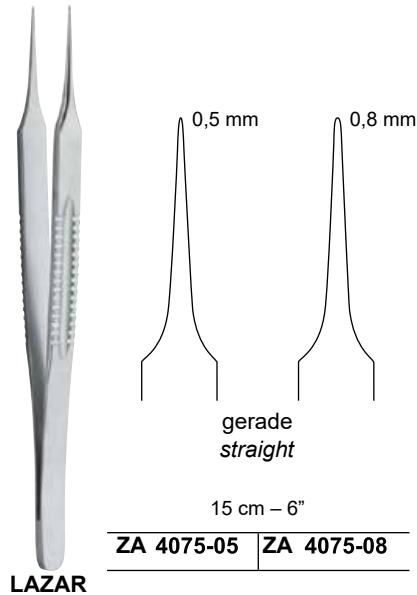
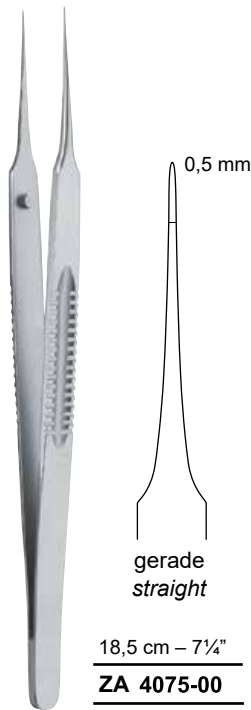

ZIMAIZ  
INTERNATIONAL

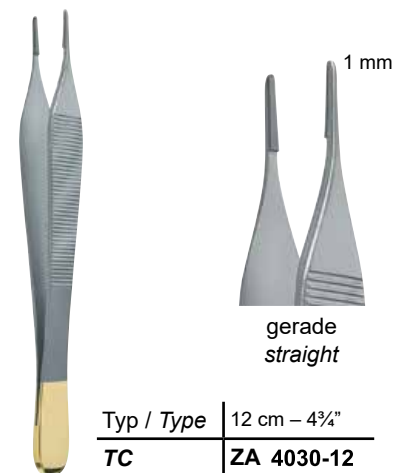
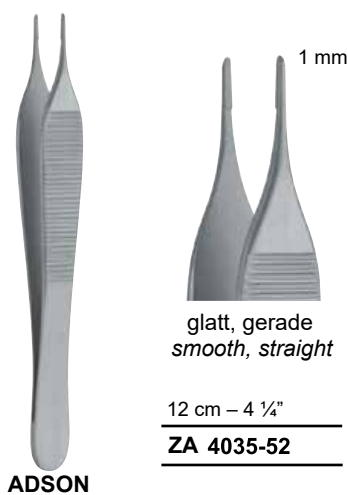

# Mikro-Nahtpinzetten Micro Suture Forceps

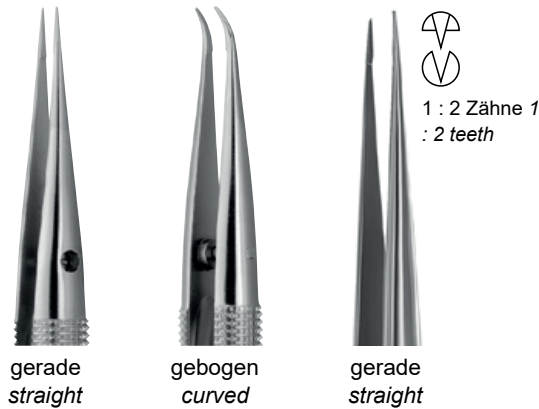

	Spitze Tip	mit Fadenplatte, 6 mm with tying platform, 6 mm		
12 cm – 4¾"	0,4 mm	<b>ZA 4068-12</b>	<b>ZA 4069-12</b>	–
15 cm – 6"	0,4 mm	<b>ZA 4068-15</b>	<b>ZA 4069-15</b>	<b>ZA 4068-32</b>
18 cm – 7"	0,4 mm	<b>ZA 4068-18</b>	<b>ZA 4069-18</b>	<b>ZA 4068-42</b>
	0,8 mm	<b>ZA 4068-19</b>	<b>ZA 4069-19</b>	<b>ZA 4068-44</b>
21 cm – 8¼"	0,8 mm	<b>ZA 4068-21</b>	<b>ZA 4069-21</b>	<b>ZA 4068-46</b>



	Typ Type	Spitze Tip	mit Fadenplatte, 6 mm with tying platform, 6 mm		
18 cm – 7"	<b>TI</b>	0,4 mm	<b>RU 4068-18T</b>	<b>RU 4069-18T</b>	<b>RU 4068-42T</b>
	<b>TI</b>	0,8 mm	<b>RU 4068-19T</b>	<b>RU 4069-19T</b>	<b>RU 4068-44T</b>
21 cm – 8¼"	<b>MC</b>	0,8 mm	<b>RU 4068-22U</b>	<b>RU 4069-22U</b>	–

gerade  
straight

gebogen  
curved

gerade  
straight

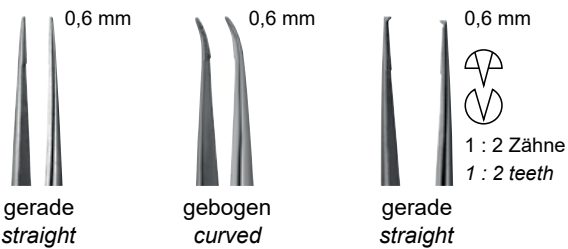

15 cm – 6"	<b>MG</b>	0,6 mm	<b>ZA 4068-51G</b>	<b>ZA 4068-52G</b>	<b>ZA 4068-63G</b>
18 cm – 7"	<b>MG</b>	0,6 mm	<b>ZA 4068-53G</b>	<b>ZA 4068-54G</b>	–
21 cm – 8¼"	<b>MG</b>	0,6 mm	<b>ZA 4068-55G</b>	<b>ZA 4068-56G</b>	–



# Anatomische Mikro-Pinzetten Dissecting Micro Forceps

## Evolution / Nano

- ¾ leichter als Titan dank neuem Griff-Design
- alle Vorzüge von Edelstahlinstrumenten
- ¾ außergewöhnlich gute Haptik für präzises Arbeiten
- ¾ problemloses Reinigen für bestmögliche Hygiene
- ¾ optimale Ergonomie dank der runden Griffschalen

## Evolution / Nano

- ¾ lighter than titanium thanks to the new handle design
- ¾ all advantages of stainless steel instruments
- ¾ unsurpassed haptics for precision during the operation
- ¾ easy cleaning for best possible hygiene
- ¾ optimal ergonomomy due to the round shell handles

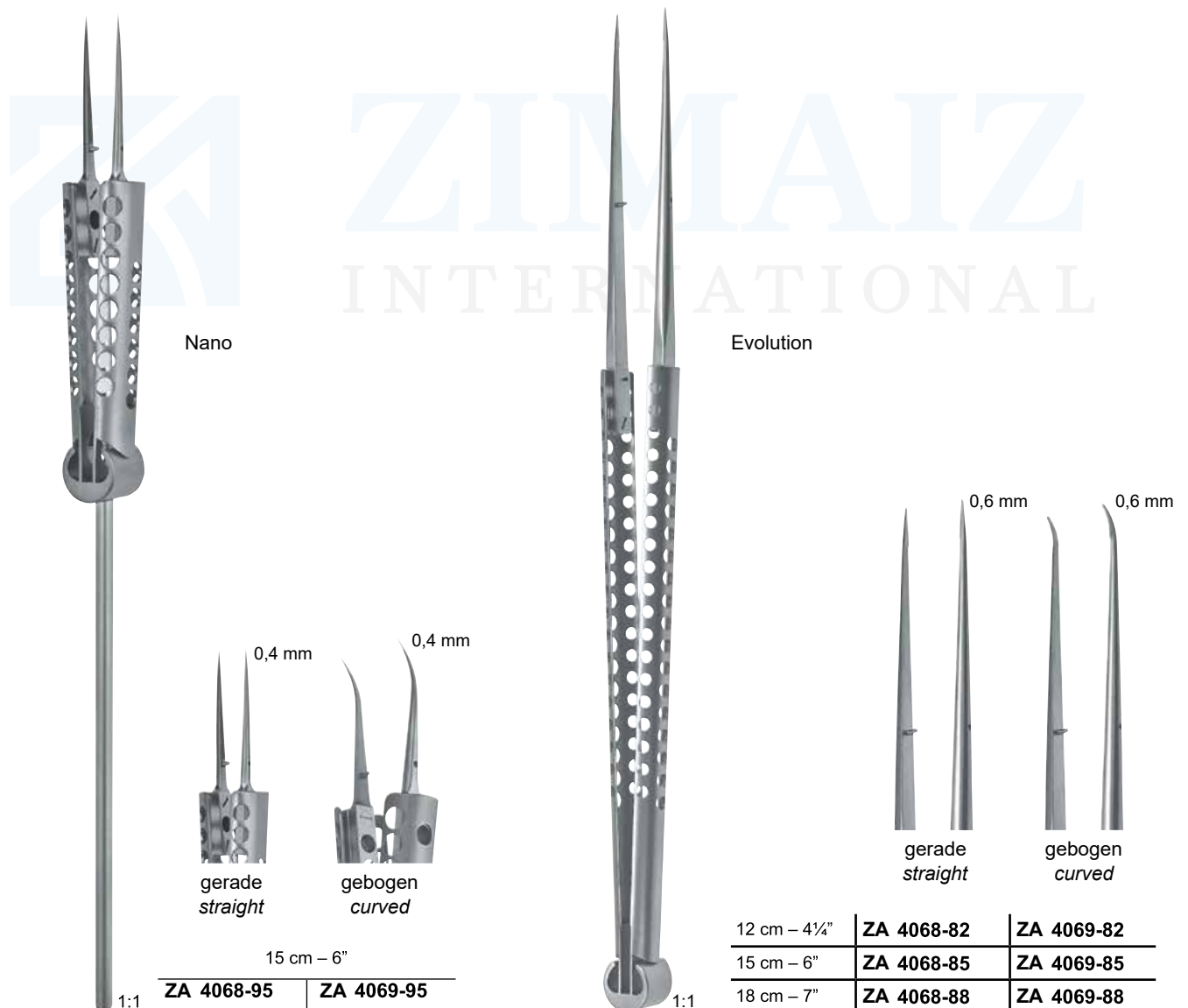

Nano

Evolution

	0,4 mm	0,4 mm
	gerade straight	gebogen curved
	15 cm – 6"	
1:1	<b>ZA 4068-95</b>	<b>ZA 4069-95</b>

	0,6 mm	0,6 mm
	gerade straight	gebogen curved
12 cm – 4 ¼"	<b>ZA 4068-82</b>	<b>ZA 4069-82</b>
15 cm – 6"	<b>ZA 4068-85</b>	<b>ZA 4069-85</b>
18 cm – 7"	<b>ZA 4068-88</b>	<b>ZA 4069-88</b>

# Anatomische Mikro-Pinzetten Dissecting Micro Forceps



bajonettförmig  
*bayonet-shaped*

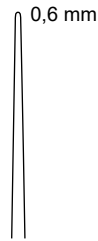

0,6 mm  
glatt, gerade  
*smooth, straight*

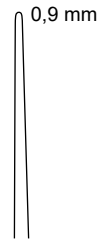

0,9 mm  
gerade  
*straight*

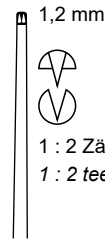

1,2 mm  
1 : 2 Zähne  
*1 : 2 teeth*

16 cm – 6¼"	<b>ZA 4063-22</b>	<b>ZA 4063-24</b>	–
18 cm – 7"	<b>ZA 4063-32</b>	<b>ZA 4063-34</b>	<b>ZA 4063-36</b>
20 cm – 8"	<b>ZA 4063-42</b>	<b>ZA 4063-44</b>	–
22 cm – 8¾"	<b>ZA 4063-52</b>	<b>ZA 4063-54</b>	–
24 cm – 9½"	<b>ZA 4063-62</b>	<b>ZA 4063-64</b>	–

**YASARGIL**



**ZIMAIZ**  
INTERNATIONAL

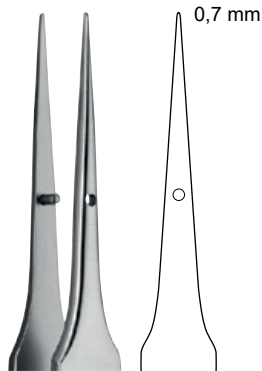

0,7 mm  
gerade  
*straight*

15 cm – 6"	<b>ZA 4065-15</b>
18 cm – 7"	<b>ZA 4065-18</b>



bajonettförmig  
*bayonet-shaped*



0,6 mm  
gerade  
*straight*

16 cm – 6 ¼"	<b>ZA 4078-16</b>
--------------	-------------------

**JACOBSEN**



# Anatomische Mikro-Pinzetten Dissecting Micro Forceps



21 cm – 8¼"  
**ZA 4078-25**

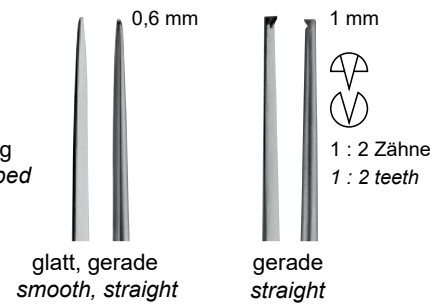

16 cm – 6¼"  
**ZA 4296-01** | **ZA 4296-02**

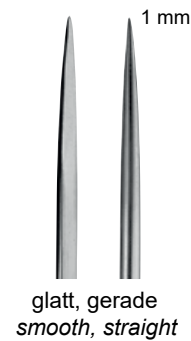

18,5 cm – 7¼"  
**ZA 4296-06**

# Anatomische Mikro-Pinzetten Dissecting Micro Forceps



bajonettförmig  
bayonet-shaped

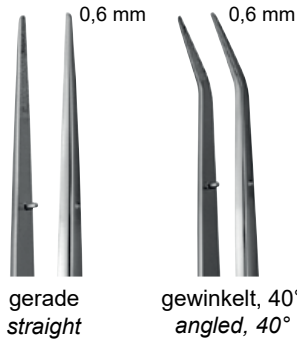

gerade  
straight

gewinkelt, 40°  
angled, 40°

Typ / Type	19 cm – 7½"	
<b>MG</b>	<b>ZA 4078-30G</b>	<b>ZA 4078-31G</b>

ZIMAIZ  
INTERNATIONAL



bajonettförmig  
bayonet-shaped



gerade  
straight



gerade  
straight

A = Ø 1 mm  
B = Ø 0,5 mm

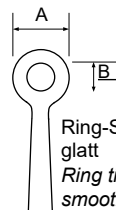

Ring-Spitze  
glatt  
Ring tip  
smooth

Typ / Type	22 cm – 8¾"	
<b>MG</b>	<b>ZA 4078-40G</b>	<b>ZA 4078-41G</b>



# Mikro-Tumorfasspinzetten Micro Tumor Grasping Forceps



bajonettförmig  
bayonet-shaped

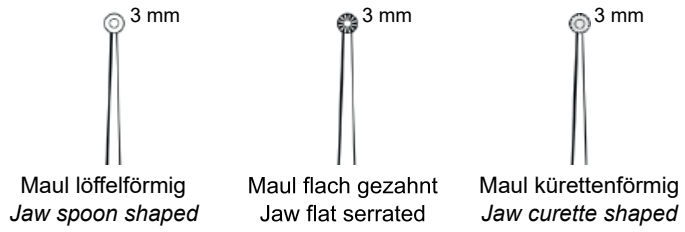

22 cm – 8¾"	<b>ZA 4078-01</b>	<b>ZA 4078-03</b>	<b>ZA 4078-05</b>
-------------	-------------------	-------------------	-------------------



22 cm – 8¾"	<b>ZA 4078-02</b>	<b>ZA 4078-04</b>	<b>ZA 4078-06</b>
-------------	-------------------	-------------------	-------------------



bajonettförmig  
bayonet-shaped

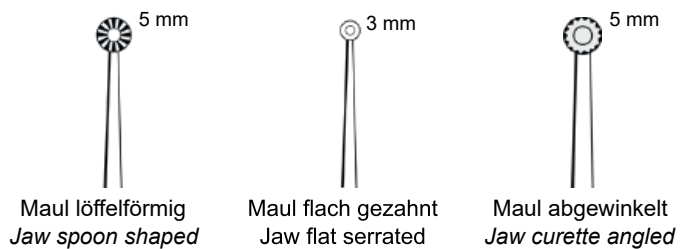

20 cm – 8"	<b>ZA 4078-10</b>	<b>ZA 4078-11</b>	<b>ZA 4078-60</b>
------------	-------------------	-------------------	-------------------

HUNT

# Mikro-Tumorfasspinzetten Micro Tumor Grasping Forceps



YASARGIL

leichter  
bajonettförmig  
*light perforated handle,  
bayonet-shaped*



Ø 3 mm



Ø 5 mm



Ø 7 mm

Lochgriff,

22 cm – 8¾"	<b>ZA 4064-51</b>	<b>ZA 4064-52</b>	–
24 cm – 9½"	<b>ZA 4064-61</b>	<b>ZA 4064-62</b>	<b>ZA 4064-63</b>



Ø 3 mm



Ø 3 mm

22 cm – 8¾"	<b>ZA 4064-54</b>	<b>ZA 4064-55</b>
-------------	-------------------	-------------------



Ø 5 mm



Ø 5 mm

22 cm – 8¾"	<b>ZA 4064-57</b>	<b>ZA 4064-58</b>
-------------	-------------------	-------------------

ZIMAIZ  
INTERNATIONAL



# Mikro-Pinzetten, Rundgriff Micro Forceps, Round Handle

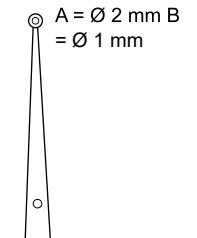
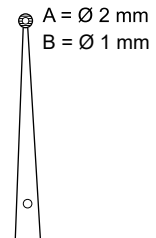
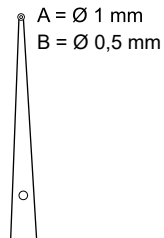
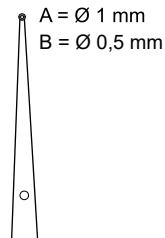
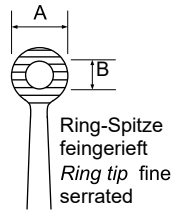
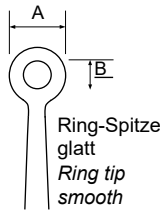

Typ  
Type

feingerieft  
fine serrated

glatt  
smooth

feingerieft  
fine serrated

glatt  
smooth

15 cm – 6"	<b>TI</b>	<b>ZA 4079-12</b>	<b>ZA 4079-14</b>	–	–
18 cm – 7"		–	–	<b>ZA 4079-36</b>	<b>ZA 4079-38</b>
18 cm – 7"	<b>TI</b>	<b>ZA 4079-32T</b>	<b>ZA 4079-34T</b>	<b>ZA 4079-36T</b>	<b>ZA 4079-38T</b>
22 cm – 8¾"		<b>ZA 4079-52</b>	<b>ZA 4079-54</b>	<b>ZA 4079-56</b>	<b>ZA 4079-58</b>

INTERNATIONAL

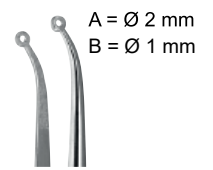
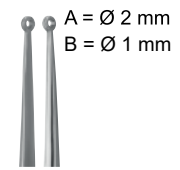
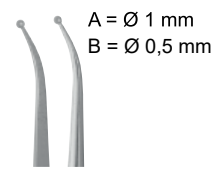
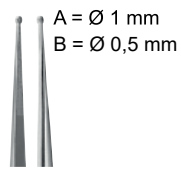

Typ  
Type

gerade  
straight

gebogen  
curved

gerade  
straight

gebogen  
curved

15 cm – 6"	<b>MG</b>	<b>ZA 4068-74G</b>	<b>ZA 4068-75G</b>	–	–
15 cm – 6"	<b>MG/TI</b>	<b>ZA 4079-12U</b>	–	<b>ZA 4079-16U</b>	–
18 cm – 7"	<b>MG</b>	<b>ZA 4079-32G</b>	<b>ZA 4079-33G</b>	<b>ZA 4079-36G</b>	<b>ZA 4079-37G</b>
18 cm – 7"	<b>MG/TI</b>	<b>ZA 4079-32U</b>	–	<b>ZA 4079-36U</b>	–
21 cm – 8¼"	<b>MG</b>	<b>ZA 4079-42G</b>	<b>ZA 4079-43G</b>	<b>ZA 4079-46G</b>	<b>ZA 4079-47G</b>

# Feine anatomische Pinzetten Delicate Dissecting Forceps

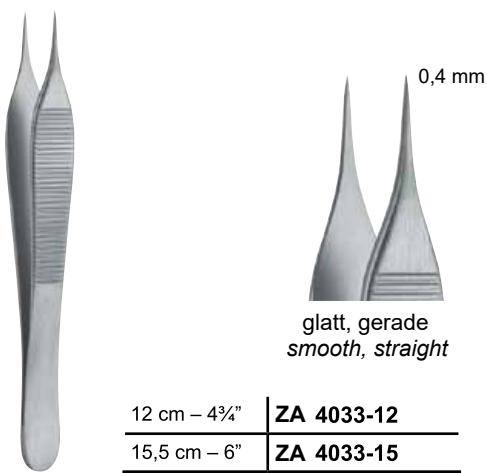

**JACOBSON-ADSON**

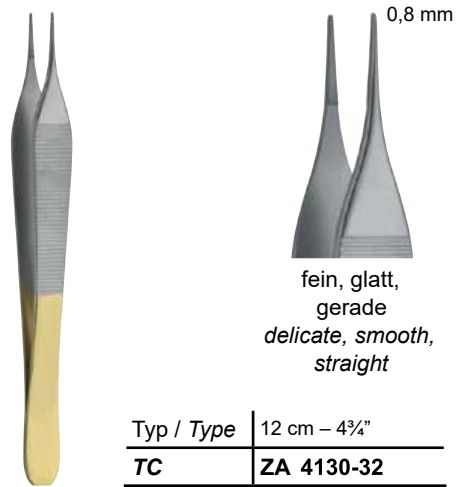

**MICRO ADSON**

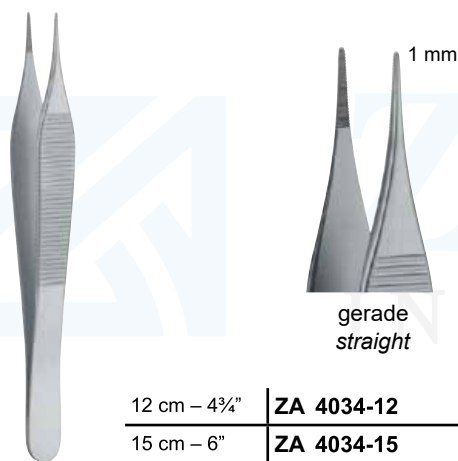

**MICRO ADSON**

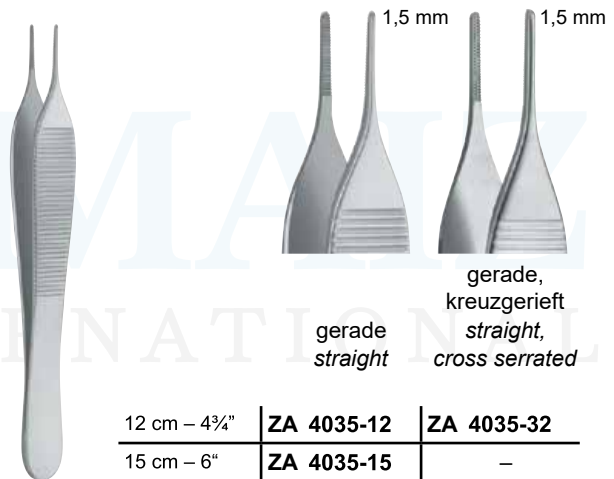

**ADSON STANDARD**

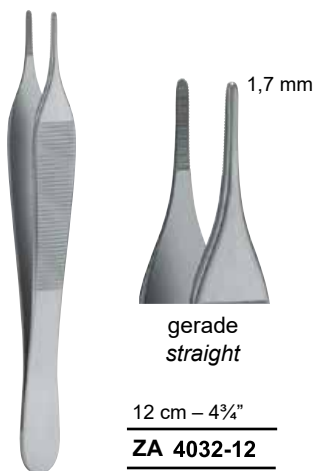

**EWALD**

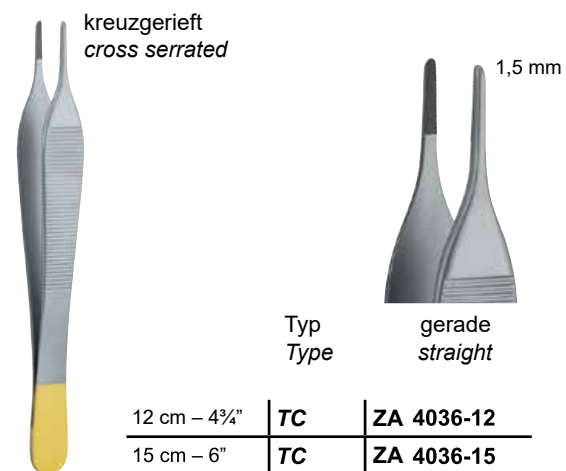

**ADSON**



# Feine anatomische Pinzetten Delicate Dissecting Forceps



**ADSON**

  
**DE BAKEY** Zahnung  
**DE BAKEY** Serration



12,5 cm – 5"	<b>ZA 7585-12</b>
15 cm – 6"	<b>ZA 7585-15</b>



**ZA 4250-10**



10 cm – 4"

**ZA 4251-10**



**ZA 4252-10**



**SEMKEN**

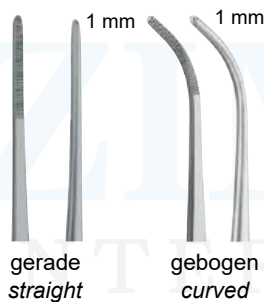

12,5 cm – 5"	<b>ZA 4040-12</b>	<b>ZA 4041-12</b>
15 cm – 6"	<b>ZA 4040-15</b>	<b>ZA 4041-15</b>



**SEMKEN**



Typ / Type	15 cm – 6"
<b>TC</b>	<b>ZA 4042-15</b>



**MC INDOE**



15 cm – 6"	<b>ZA 4038-15</b>
------------	-------------------



**MC INDOE**



Typ / Type	15 cm – 6"
<b>TC</b>	<b>ZA 4039-15</b>

# Feine anatomische Pinzetten Delicate Dissecting Forceps



gerade  
straight

17,5 cm – 7"

**ZA 4048-18**

**BRAIN**



gerade  
straight

15 cm – 6"

**ZA 4055-15**

18 cm – 7"

**ZA 4055-18**

20 cm – 8"

**ZA 4055-20**

**WAUGH**

ZIMAIZ  
INTERNATIONAL



glatt, gerade  
smooth, straight

18 cm – 7"

**ZA 4056-18**

20 cm – 8"

**ZA 4056-20**



# Feine anatomische Pinzetten Delicate Dissecting Forceps



bajonettförmig  
bayonet-shaped



19 cm – 7½"

**ZA 4071-59**

GERALD

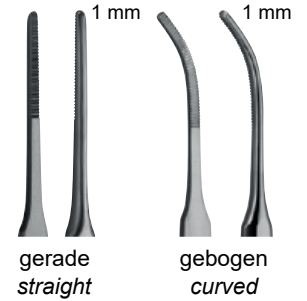

17,5 cm – 7"

Typ / Type	<b>ZA 4070-17</b>	<b>ZA 4071-17</b>
TI	<b>ZA 4070-17T</b>	-

GERALD



ZIMAIZ  
INTERNATIONAL



kreuzgerieft  
cross serrated



Typ / Type | 17,5 cm – 7"

**TC** | **ZA 4070-57**

GERALD

# Feine anatomische Pinzetten Delicate Dissecting Forceps

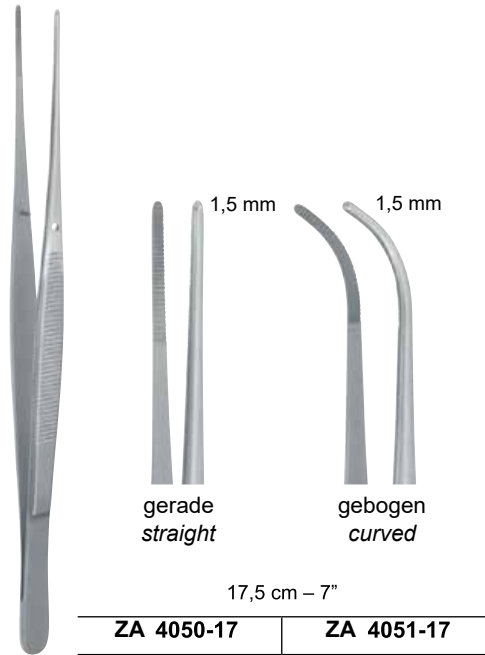

17,5 cm - 7"  
**ZA 4050-17** | **ZA 4051-17**

TAYLOR

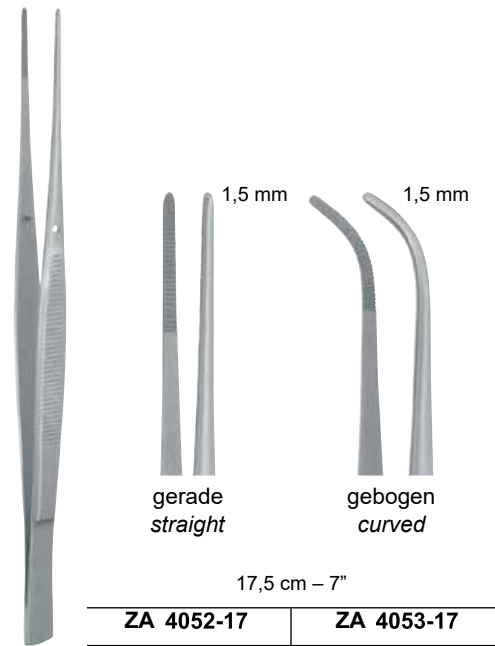

17,5 cm - 7"  
**ZA 4052-17** | **ZA 4053-17**

TAYLOR

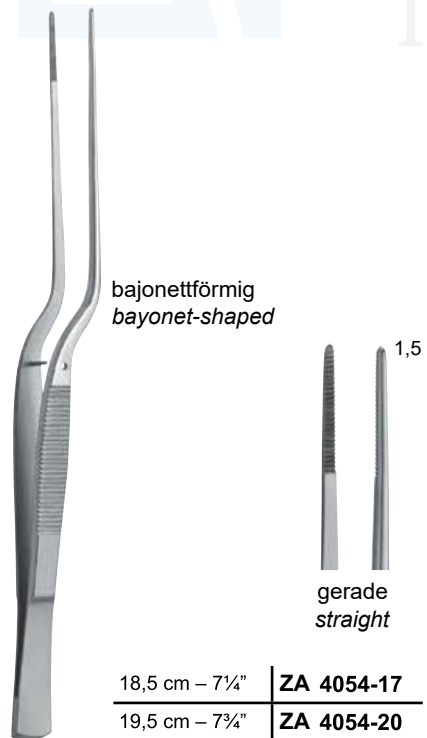

18,5 cm - 7 1/4" | **ZA 4054-17**  
 19,5 cm - 7 3/4" | **ZA 4054-20**

TAYLOR





# Feine anatomische Pinzetten Delicate Dissecting Forceps

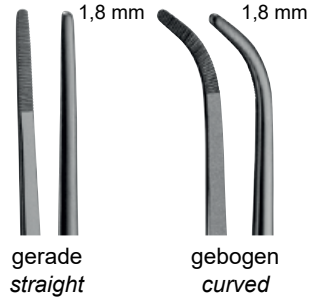

gerade  
straight

gebogen  
curved

18 cm – 7"

ZA 4080-17

ZA 4081-17

CUSHING

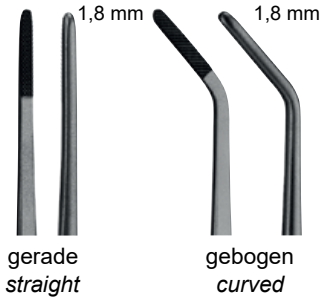

gerade  
straight

gebogen  
curved

18 cm – 7"

Typ / Type

TC

ZA 4082-17

ZA 4082-27

CUSHING



bajonettförmig  
bayonet-shaped



gerade  
straight

Typ / Type | 18 cm – 7"

TC

ZA 4083-17

CUSHING-TAYLOR

Feine anatomische Pinzetten  
Delicate Dissecting Forceps

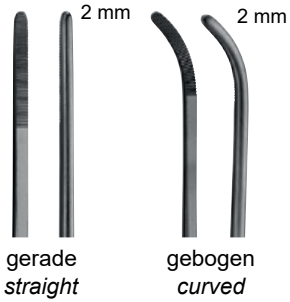

gerade  
straight

gebogen  
curved

20 cm – 8"

**ZA 4060-20**

**ZA 4061-20**



gewinkelt  
angled

20 cm – 8"

**ZA 4057-20**

**BROPHY**



ZIMAIZ  
INTERNATIONAL



gerade  
straight

20 cm – 8"

**ZA 4058-20**



# Feine anatomische Pinzetten Delicate Dissecting Forceps



POTTS-SMITH

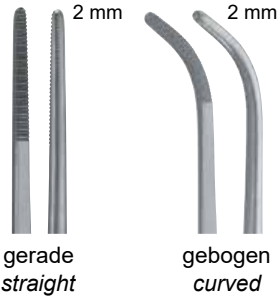

gerade  
straight

gebogen  
curved

18 cm – 7"	<b>ZA 4090-18</b>	<b>ZA 4091-18</b>
21 cm – 8¼"	<b>ZA 4090-21</b>	<b>ZA 4091-21</b>
25 cm – 10"	<b>ZA 4090-25</b>	<b>ZA 4091-25</b>



POTTS-SMITH



Typ  
Type gerade  
straight

15 cm – 6"	<b>TC</b>	<b>ZA 4092-15</b>
18 cm – 7"	<b>TC</b>	<b>ZA 4092-18</b>
20 cm – 8"	<b>TC</b>	<b>ZA 4092-20</b>
23 cm – 9"	<b>TC</b>	<b>ZA 4092-23</b>
25 cm – 10"	<b>TC</b>	<b>ZA 4092-25</b>



GRÜNWALD

bajonettförmig  
bayonet-shaped



gerade  
straight

Typ / Type	19 cm – 7½"
<b>TC</b>	<b>ZA 4084-18</b>

# Anatomische Pinzetten Dissecting Forceps





**Standard**



  
 gerade  
*straight*

  
 gebogen  
*curved*

  
 mittelbreit, gerade  
*medium, straight*

  
 mittelbreit, gebogen  
*medium, curved*

10,5 cm – 4¼"	<b>ZA 4000-10</b>	–	–	–
11,5 cm – 4½"	<b>ZA 4000-11</b>	<b>ZA 4001-11</b>	<b>ZA 4010-11</b>	<b>ZA 4011-11</b>
13 cm – 5"	<b>ZA 4000-13</b>	<b>ZA 4001-13</b>	<b>ZA 4010-13</b>	<b>ZA 4011-13</b>
14,5 cm – 5¾"	<b>ZA 4000-14</b>	<b>ZA 4001-14</b>	<b>ZA 4010-14</b>	<b>ZA 4011-14</b>
15,5 cm – 6"	<b>ZA 4000-15</b>	–	–	–
16 cm – 6¼"	<b>ZA 4000-16</b>	<b>ZA 4001-16</b>	<b>ZA 4010-16</b>	<b>ZA 4011-16</b>
18 cm – 7"	<b>ZA 4000-18</b>	<b>ZA 4001-18</b>	<b>ZA 4010-18</b>	<b>ZA 4011-18</b>
20 cm – 8"	<b>ZA 4000-20</b>	<b>ZA 4001-20</b>	<b>ZA 4010-20</b>	<b>ZA 4011-20</b>
25 cm – 10"	<b>ZA 4000-25</b>	<b>ZA 4001-25</b>	<b>ZA 4010-25</b>	<b>ZA 4011-25</b>
30 cm – 11¾"	<b>ZA 4000-30</b>	<b>ZA 4001-30</b>	<b>ZA 4010-30</b>	<b>ZA 4011-30</b>



**Standard**



  
 Typ  
Type  
gerade  
*straight*

14,5 cm – 5¾"	<b>TC</b>	<b>ZA 4002-14</b>
16 cm – 6¼"	<b>TC</b>	<b>ZA 4002-16</b>
18 cm – 7"	<b>TC</b>	<b>ZA 4002-18</b>
20 cm – 8"	<b>TC</b>	<b>ZA 4002-20</b>
25 cm – 10"	<b>TC</b>	<b>ZA 4002-25</b>

**Schwedisches Modell  
Swedish pattern**



  
 gerade  
*straight*

13 cm – 5"	<b>ZA 4013-13</b>
15 cm – 6"	<b>ZA 4013-15</b>
17 cm – 6¾"	<b>ZA 4013-17</b>
20 cm – 8"	<b>ZA 4013-20</b>

**STILLE**



# Anatomische Pinzetten Dissecting Forceps

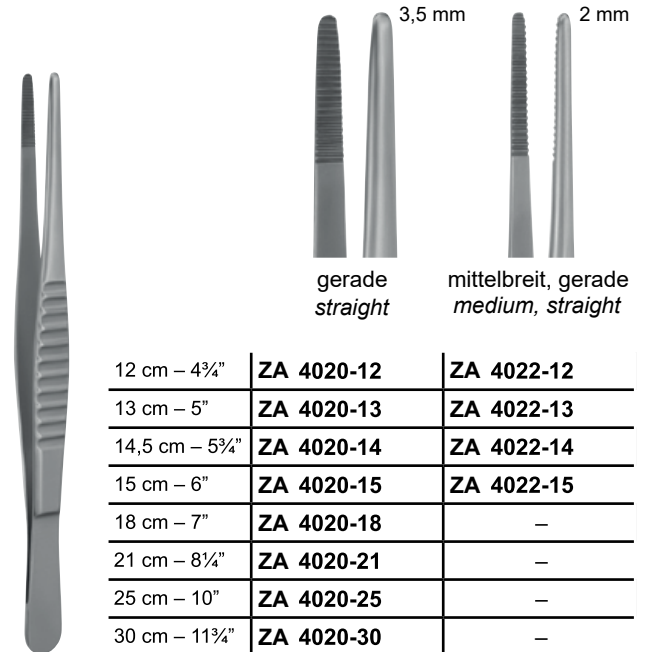
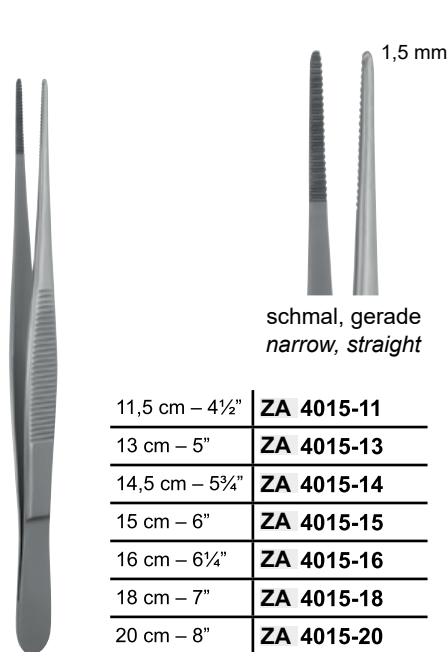

MODELL USA  
USA PATTERN

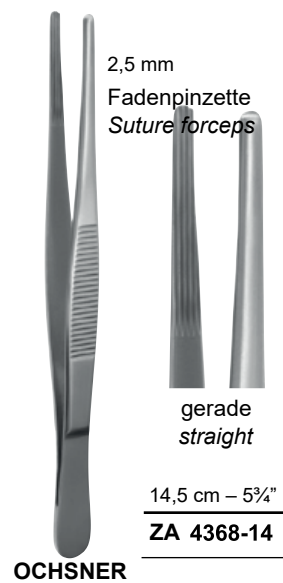



**WANGENSTEEN**



Typ  
Type gerade  
straight

15 cm – 6"	TC	ZA 4085-15
23 cm – 9"	TC	ZA 4085-23
25 cm – 10"	TC	ZA 4085-25



gerade  
straight

23 cm – 9"

**ZA 4086-23**



Hypophysenpinzette  
*Pituitary forceps*

bajonettförmig  
*bayonet-shaped*

**ADSON**



6 mm

gerade  
straight

23 cm – 9"

**ZA 4078-20**

ZIMAIZ  
INTERNATIONAL



# Atraumatische Pinzetten Atraumatic Forceps



**DE BAKEY** Zahnung  
**DE BAKEY** Serration

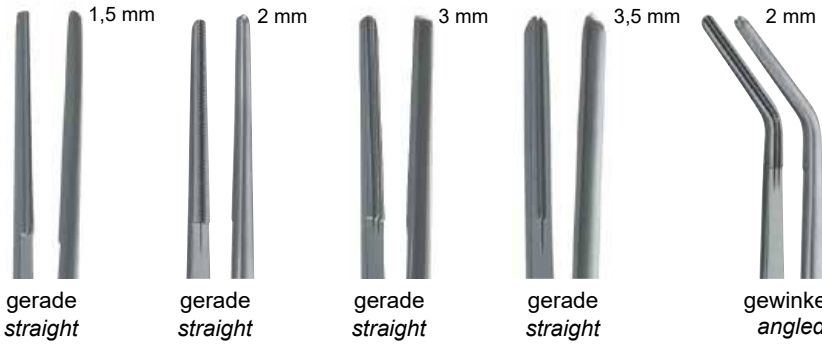

15 cm – 6"	<b>ZA 7580-16</b>	<b>ZA 7581-16</b>	<b>ZA 7582-16</b>	<b>ZA 7583-16</b>	<b>ZA 7584-16</b>
20 cm – 8"	<b>ZA 7580-20</b>	<b>ZA 7581-20</b>	<b>ZA 7582-20</b>	<b>ZA 7583-20</b>	<b>ZA 7584-20</b>
24 cm – 9½"	<b>ZA 7580-24</b>	<b>ZA 7581-24</b>	<b>ZA 7582-24</b>	<b>ZA 7583-24</b>	<b>ZA 7584-24</b>
30 cm – 11¼"	<b>ZA 7580-30</b>	<b>ZA 7581-30</b>	<b>ZA 7582-30</b>	<b>ZA 7583-30</b>	<b>ZA 7584-30</b>

**DE BAKEY**



**DE BAKEY** Zahnung  
**DE BAKEY** Serration

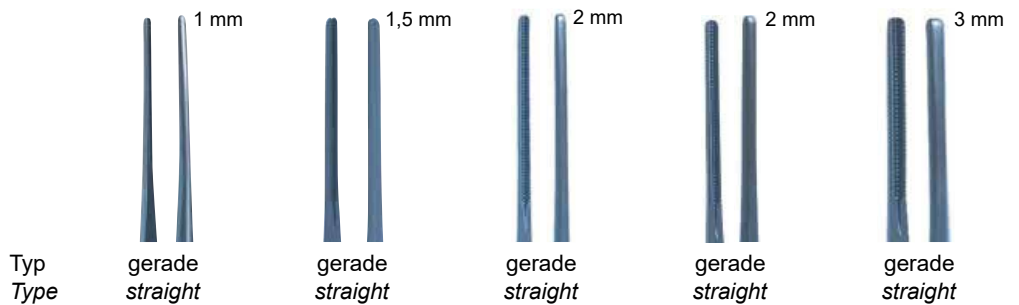

15 cm – 6"	<b>TI</b>	<b>ZA 7580-01T</b>	<b>ZA 7580-16T</b>	<b>ZA 7581-01T</b>	<b>ZA 7582-01T</b>	<b>ZA 7582-16T</b>
20 cm – 8"	<b>TI</b>	<b>ZA 7580-02T</b>	<b>ZA 7580-20T</b>	<b>ZA 7581-02T</b>	<b>ZA 7582-02T</b>	<b>ZA 7582-20T</b>
24 cm – 9½"	<b>TI</b>	<b>ZA 7580-03T</b>	<b>ZA 7580-24T</b>	<b>ZA 7581-03T</b>	<b>ZA 7582-03T</b>	<b>ZA 7582-24T</b>

**DE BAKEY**

# Ohrpinzetten Ear Dressing Forceps



bajonettförmig  
bayonet-shaped



1 : 2 Zähne  
1 : 2 teeth

14 cm – 5½"

1 mm	<b>ZA 7862-24</b>	<b>ZA 7863-14</b>
2 mm	<b>ZA 7862-14</b>	–

**LUCAE**



Fixierpinzette  
Fixing forceps

bajonettförmig  
bayonet-shaped



gerade, gezahnt,  
gerieft  
straight, toothed,  
serrated

14 cm – 5½"

**ZA 7863-15**

**COTTLE**



ZIMAIZ  
INTERNATIONAL



bajonettförmig  
bayonet-shaped



1 : 2 Zähne  
1 : 2 teeth

	2,2 mm	1 mm
16 cm – 6¼"	<b>ZA 7864-16</b>	<b>ZA 7864-26</b>
19,5 cm – 7¾"	<b>ZA 7864-18</b>	<b>ZA 7864-28</b>
21 cm – 8¼"	<b>ZA 7864-20</b>	<b>ZA 7864-30</b>

**JANSEN-GRUENWALD**



bajonettförmig  
bayonet-shaped



16 cm – 6¼"	<b>ZA 7865-16</b>
20 cm – 8"	<b>ZA 7865-20</b>

**JANSEN**



# Ohrpinzetten Ear Dressing Forceps

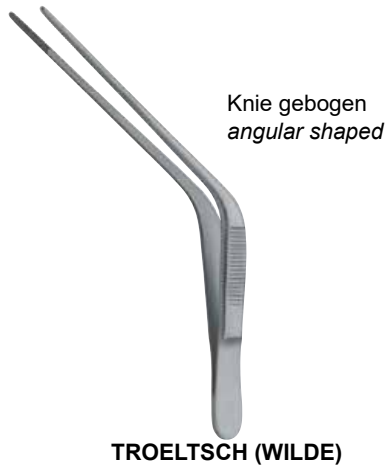

10,5 cm – 4¼"	<b>ZA 7860-11</b>
11,5 cm – 4½"	<b>ZA 7860-12</b>
15 cm – 6"	<b>ZA 7860-15</b>
18 cm – 7"	<b>ZA 7860-18</b>



2 mm

1 : 2 Zähne  
1 : 2 teeth

12 cm – 4¾"	<b>ZA 7861-12</b>
-------------	-------------------

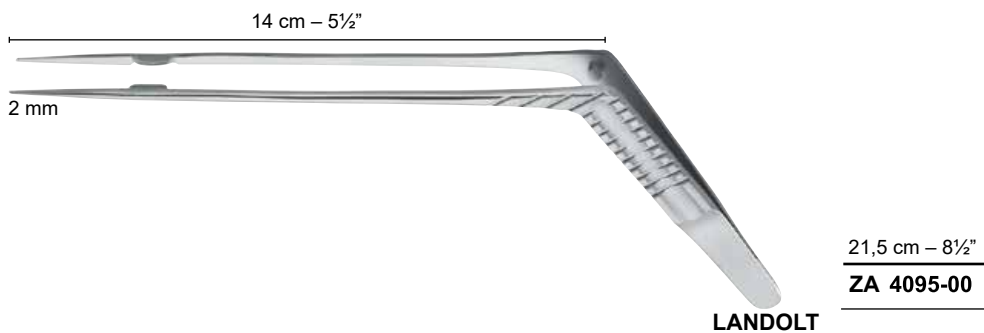

# Feine chirurgische Pinzetten Delicate Tissue Forceps



1 : 2 Zähne  
1 : 2 teeth

<p>gerade <i>straight</i></p> <p>sehr fein <i>very delicate</i></p> <p><b>ZA 4260-10</b></p>	<p>leicht gebogen <i>slightly curved</i></p> <p>sehr fein <i>very delicate</i></p> <p>10 cm – 4"</p> <p><b>ZA 4261-10</b></p>	<p>stark gebogen <i>strongly curved</i></p> <p>sehr fein <i>very delicate</i></p> <p><b>ZA 4262-10</b></p>
--	---	--

1 : 2 Zähne  
1 : 2 teeth

<p>gerade, kreuzgerieft <i>straight, cross serrated</i></p>		<p>gerade <i>straight</i></p>	
---	--	-----------------------------------	--

12 cm – 4¾"

<b>ZA 4133-01</b>	<b>ZA 4133-02</b>	<b>ZA 4133-03</b>	<b>ZA 4133-04</b>
-------------------	-------------------	-------------------	-------------------

**ADSON**

1 : 2 Zähne  
1 : 2 teeth

1 : 2 Zähne  
1 : 2 teeth

<p>15 cm – 6"</p> <p><b>ZA 4133-10</b></p>	<p>gerade <i>straight</i></p>
--	-----------------------------------

12 cm – 4¾"	TC	<b>ZA 4130-12</b>	<b>ZA 4130-22</b>
15 cm – 6"	TC	<b>ZA 4130-15</b>	<b>ZA 4130-25</b>

**ADSON**      **MICRO ADSON**



# Feine chirurgische Pinzetten Delicate Tissue Forceps

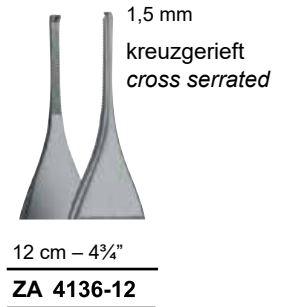

	1,5 mm	2 mm
	1 : 2 Zähne 1 : 2 teeth	2 : 3 Zähne 2 : 3 teeth
12 cm – 4¾"	<b>ZA 4135-12</b>	<b>ZA 4135-52</b>
15 cm – 6"	<b>ZA 4135-15</b>	<b>ZA 4135-55</b>



	2 mm
Typ Type	gerade <i>straight</i>
12 cm – 4¾"	<b>TC ZA 4134-12</b>
15 cm – 6"	<b>TC ZA 4134-15</b>

# Feine chirurgische Pinzetten Delicate Tissue Forceps



1 : 2 Zähne  
1 : 2 teeth



0,8 mm  
Zähne schräggestellt  
Teeth in oblique position

12 cm – 4¾"

**ZA 4131-12**

**MICRO-ADSON-BIEMER**



1 : 2 Zähne  
1 : 2 teeth

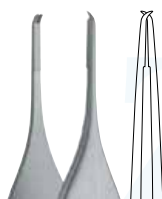

kreuzgerieft  
cross serrated

12 cm – 4¾"

**ZA 4136-72**

**ADSON**



1 : 2 Zähne  
1 : 2 teeth

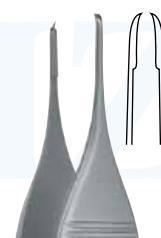

1 mm

12 cm – 4¾"

**ZA 4135-82**

**ADSON**



1 : 2 Zähne  
1 : 2 teeth



0,6 mm

gerade  
straight



0,8 mm

gerade  
straight



1 mm

gerade  
straight

15 cm – 6"

**ZA 4147-01**

**ZA 4147-02**

**ZA 4147-03**



# Feine chirurgische Pinzetten Delicate Tissue Forceps

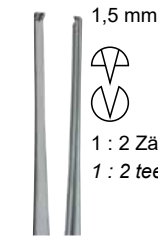

**SEMKEN**



**SEMKEN**

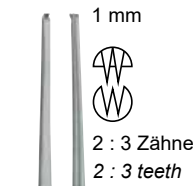

**MICRO-SEMKEN**



**MICRO-SEMKEN**

12,5 cm – 5"	<b>ZA 4140-12</b>	<b>ZA 4141-12</b>	<b>ZA 4140-30</b>	<b>ZA 4142-12</b>
15 cm – 6"	<b>ZA 4140-15</b>	<b>ZA 4141-15</b>	<b>ZA 4140-31</b>	<b>ZA 4142-15</b>

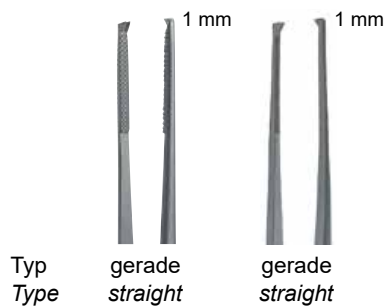

14,5 cm – 5"	<b>TC</b>	<b>ZA 4140-24</b>	–
16 cm – 6¼"	<b>TC</b>	–	<b>ZA 4140-26</b>
18 cm – 7"	<b>TC</b>	<b>ZA 4140-28</b>	–

**MICRO-SEMKEN**

# Feine chirurgische Pinzetten Delicate Tissue Forceps

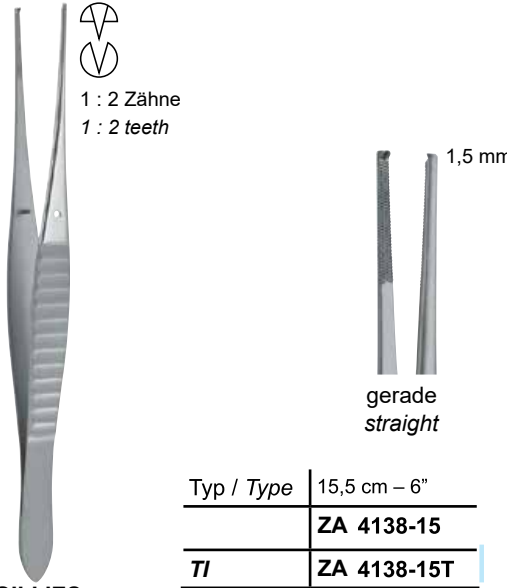
1 : 2 Zähne  
1 : 2 teeth

1,5 mm

gerade  
straight

Typ / Type	15,5 cm – 6"
	<b>ZA 4138-15</b>
<b>TI</b>	<b>ZA 4138-15T</b>

**GILLIES**

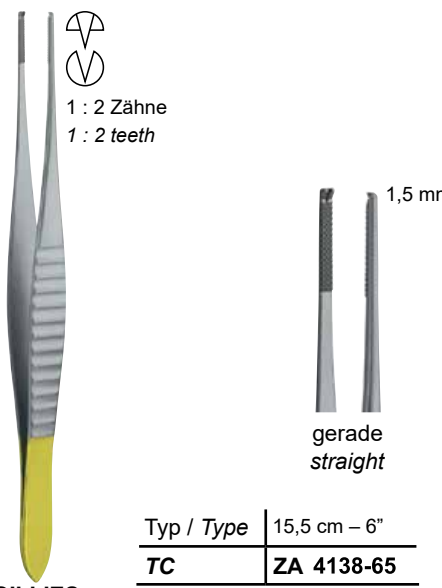

1 : 2 Zähne  
1 : 2 teeth

1,5 mm

gerade  
straight

Typ / Type	15,5 cm – 6"
	<b>ZA 4138-65</b>
<b>TC</b>	<b>ZA 4138-65</b>

**GILLIES**



ZIMAIZ  
INTERNATIONAL

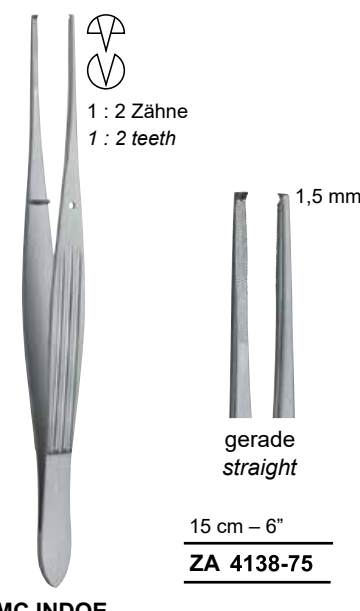

1 : 2 Zähne  
1 : 2 teeth

1,5 mm

gerade  
straight

	15 cm – 6"
	<b>ZA 4138-75</b>

**MC INDOE**



1 : 2 Zähne  
1 : 2 teeth

1 mm

gerade  
straight

	17,5 cm – 7"
	<b>ZA 4148-18</b>

**BRAIN**



# Feine chirurgische Pinzetten Delicate Tissue Forceps



  
 1 : 2 Zähne  
 1 : 2 teeth





1,5 mm

Typ  
 Type  
 gerade  
 straight

14,5 cm – 5¾"	TC	ZA 4101-14
16 cm – 6¼"	TC	ZA 4101-16
18 cm – 7"	TC	ZA 4101-18
20 cm – 8"	TC	ZA 4101-20
25 cm – 10"	TC	ZA 4101-25
30 cm – 11¾"	TC	ZA 4101-30

**OEHLER**



  
 1 : 2 Zähne  
 1 : 2 teeth





1,5 mm

gerade  
 straight

15 cm – 6"	ZA 4155-15
18 cm – 7"	ZA 4155-18
20 cm – 8"	ZA 4155-20
25 cm – 10"	ZA 4155-25
30 cm – 11¾"	ZA 4155-30

**WAUGH**





  
 1 : 2 Zähne  
 1 : 2 teeth



1,5 mm

gerade  
straight





1,5 mm

gebogen  
curved

18 cm – 7"	ZA 4190-18	ZA 4191-18
21 cm – 8¼"	ZA 4190-21	ZA 4191-21
25 cm – 10"	ZA 4190-25	ZA 4191-25

**POTTS-SMITH**



  
 1 : 2 Zähne  
 1 : 2 teeth



1,8 mm

gerade  
straight



1,8 mm

gebogen  
curved



18 cm – 7"	ZA 4180-17	ZA 4181-17
------------	------------	------------

**CUSHING**

# Feine chirurgische Pinzetten Delicate Tissue Forceps



  
 1 : 2 Zähne  
 1 : 2 teeth

gerade  
*straight*



gebogen  
*curved*

20 cm – 8"

<b>ZA 4160-20</b>	<b>ZA 4161-20</b>
-------------------	-------------------

**BROPHY**

  
 1 : 2 Zähne  
 1 : 2 teeth

gerade  
*straight*

gebogen  
*curved*

17,5 cm – 7"

<b>ZA 4170-18</b>	<b>ZA 4171-18</b>
-------------------	-------------------

**GERALD**

  
 1 : 2 Zähne  
 1 : 2 teeth



bajonettförmig  
*bayonet-shaped*



gerade  
*straight*

19 cm – 7½"

<b>ZA 4171-59</b>
-------------------

**GERALD**

ZIMAIZ  
INTERNATIONAL



# Feine chirurgische Pinzetten Delicate Tissue Forceps

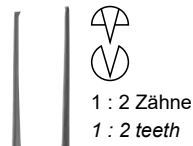

17,5 cm – 7"

ZA 4150-17

ZA 4151-17

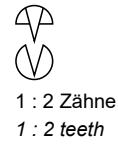

mit Dissektorende  
with dissector end

17,5 cm – 7"

ZA 4152-17

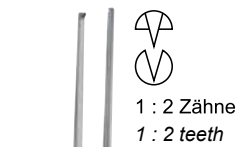

mit Dissektorende  
with dissector end

18 cm – 7"

ZA 4154-17

20 cm – 6"

ZA 4154-20



1 : 2 Zähne  
1 : 2 teeth

Standard Modell  
Standard pattern



gerade  
straight

10,5 cm – 4¼"	<b>ZA 4100-10</b>
11,5 cm – 4½"	<b>ZA 4100-11</b>
13 cm – 5"	<b>ZA 4100-13</b>
14,5 cm – 5¾"	<b>ZA 4100-14</b>
15,5 cm – 6"	<b>ZA 4100-15</b>
16 cm – 6¼"	<b>ZA 4100-16</b>
18 cm – 7"	<b>ZA 4100-18</b>
20 cm – 8"	<b>ZA 4100-20</b>
25 cm – 10"	<b>ZA 4100-25</b>
30 cm – 11¾"	<b>ZA 4100-30</b>



1 : 2 Zähne  
1 : 2 teeth



mittelbreit, gerade  
medium, straight



mittelbreit, gebogen  
medium, curved

11,5 cm – 4½"	<b>ZA 4110-11</b>	–
13 cm – 5"	<b>ZA 4110-13</b>	–
14,5 cm – 5¾"	<b>ZA 4110-14</b>	<b>ZA 4111-14</b>
15,5 cm – 6"	–	–
16 cm – 6¼"	<b>ZA 4110-16</b>	–
18,5 cm – 7¼"	<b>ZA 4110-18</b>	–
20 cm – 8"	<b>ZA 4110-20</b>	–
25 cm – 10"	<b>ZA 4110-25</b>	–



1 : 2 Zähne  
1 : 2 teeth



gerade  
straight

16 cm – 6¼"

**ZA 4109-16**



# Chirurgische Pinzetten Tissue Forceps



Standard Modell  
Standard pattern



3 mm  
2 : 3 Zähne  
2 : 3 teeth

gerade  
straight

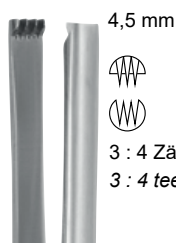

4,5 mm  
3 : 4 Zähne  
3 : 4 teeth

gerade  
straight

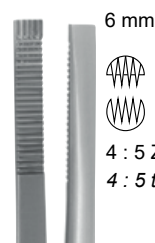

6 mm  
4 : 5 Zähne  
4 : 5 teeth

gerade  
straight

11,5 cm – 4½"	–	<b>ZA 4103-13</b>	–
13 cm – 5"	<b>ZA 4102-13</b>	<b>ZA 4103-14</b>	<b>ZA 4104-13</b>
14,5 cm – 5¾"	<b>ZA 4102-14</b>	–	<b>ZA 4104-14</b>
15,5 cm – 6"	–	<b>ZA 4103-16</b>	–
16 cm – 6¼"	<b>ZA 4102-16</b>	–	<b>ZA 4104-16</b>
18 cm – 7"	<b>ZA 4102-18</b>	–	–
20 cm – 8"	<b>ZA 4102-20</b>	<b>ZA 4103-20</b>	–
25 cm – 10"	<b>ZA 4102-25</b>	–	–
30 cm – 11¾"	<b>ZA 4102-30</b>	–	–



MODELL USA  
USA PATTERN

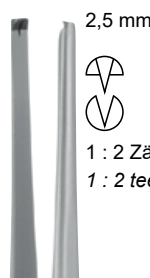

2,5 mm  
1 : 2 Zähne  
1 : 2 teeth

gerade  
straight



3 mm  
2 : 3 Zähne  
2 : 3 teeth

gerade  
straight

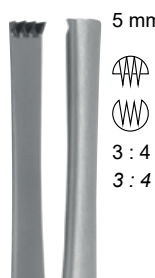

5 mm  
3 : 4 Zähne  
3 : 4 teeth

gerade  
straight



2 mm  
1 : 2 Zähne  
1 : 2 teeth

schmal, gerade  
narrow, straight

12 cm – 4¾"	<b>ZA 4120-12</b>	<b>ZA 4122-12</b>	–	–
13 cm – 5"	<b>ZA 4120-13</b>	<b>ZA 4122-13</b>	–	<b>ZA 4126-13</b>
14,5 cm – 5¾"	<b>ZA 4120-14</b>	<b>ZA 4122-14</b>	<b>ZA 4123-14</b>	<b>ZA 4126-14</b>
15,5 cm – 6"	<b>ZA 4120-15</b>	–	–	<b>ZA 4126-15</b>
18,5 cm – 7¼"	<b>ZA 4120-18</b>	<b>ZA 4122-18</b>	–	–
21 cm – 8¼"	<b>ZA 4120-21</b>	<b>ZA 4122-21</b>	–	–
25 cm – 10"	<b>ZA 4120-25</b>	<b>ZA 4122-25</b>	–	–
31 cm – 12¼"	<b>ZA 4120-31</b>	<b>ZA 4122-31</b>	–	–

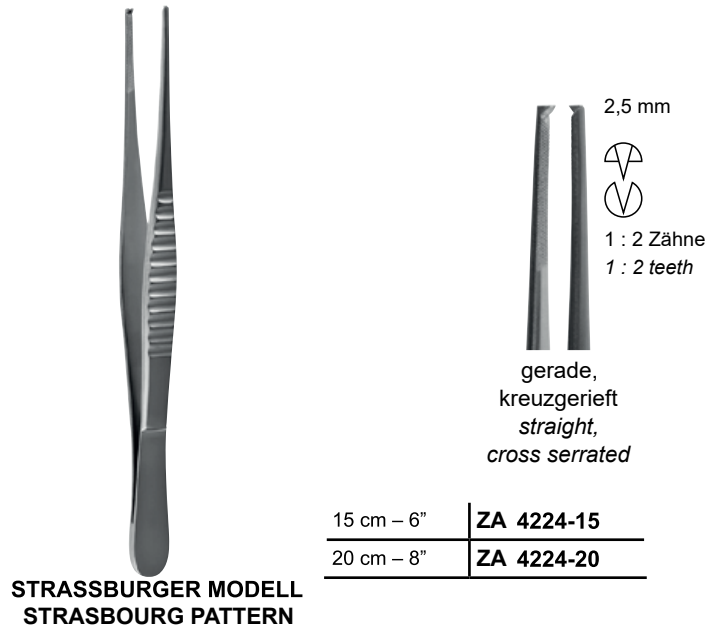
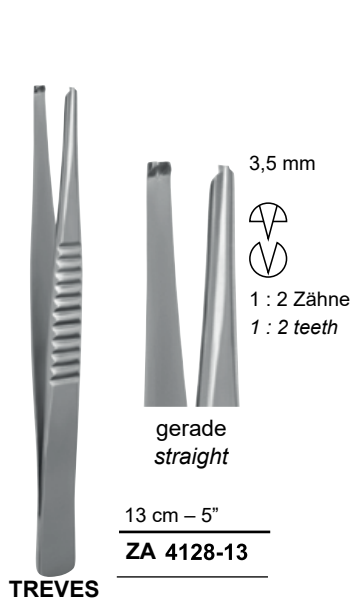

# ZIMAIZ INTERNATIONAL

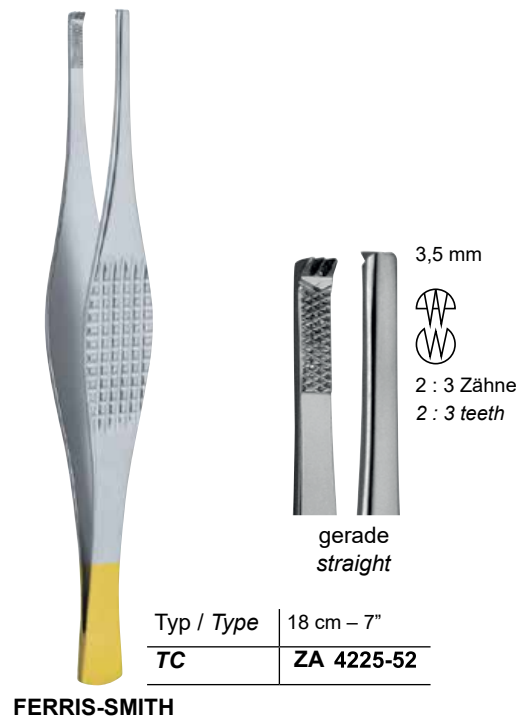
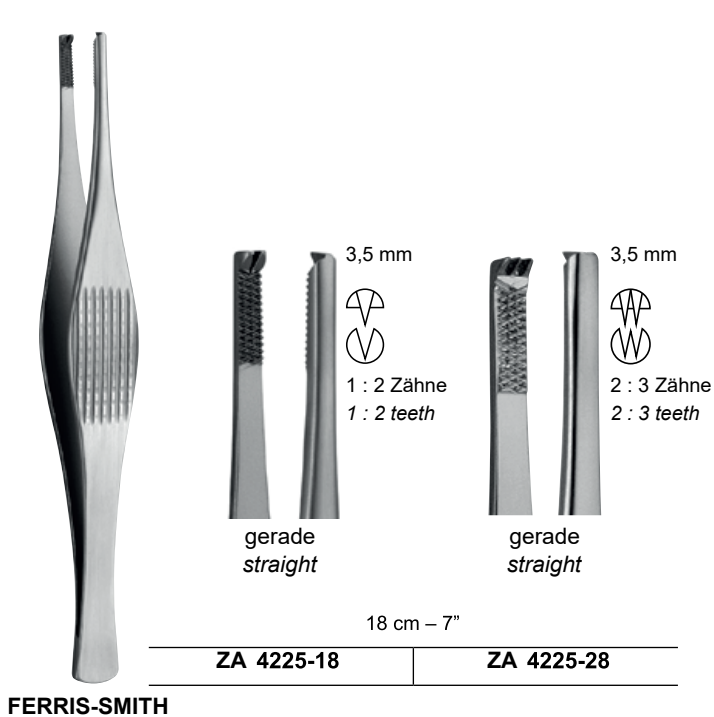



# Chirurgische Pinzetten Tissue Forceps



**LANE**

14,5 cm – 5¾"	<b>ZA 4226-14</b>	<b>ZA 4227-14</b>
20 cm – 8"	<b>ZA 4226-20</b>	<b>ZA 4227-20</b>



**STILLE-BARRAYA**

18 cm – 7"	<b>ZA 4228-18</b>
20 cm – 8"	<b>ZA 4228-20</b>
25 cm – 10"	<b>ZA 4228-25</b>



4 mm  
1 : 2 Zähne  
1 : 2 teeth

gerade  
straight



4,5 mm  
2 : 3 Zähne  
2 : 3 teeth

gerade  
straight



3 mm  
3 : 4 Zähne  
3 : 4 teeth

gerade,  
kreuzgerieft  
straight,  
cross serrated





**BONNEY**

<b>ZA 4229-18</b>	<b>ZA 4230-18</b>
-------------------	-------------------



**NEW ORLEANS**

15 cm – 6"	<b>ZA 4144-15</b>	<b>ZA 4145-15</b>
20 cm – 8"	<b>ZA 4144-20</b>	<b>ZA 4145-20</b>
25 cm – 10"	<b>ZA 4144-25</b>	<b>ZA 4145-25</b>



4 mm  
1 : 2 Zähne  
1 : 2 teeth



4 mm  
2 : 3 Zähne  
2 : 3 teeth



2,5 mm  
2 : 3 Zähne  
2 : 3 teeth

gerade  
straight



4,0 mm  
4 : 5 Zähne  
4 : 5 teeth

gerade  
straight



**ADSON-BROWN**

12 cm – 4¾"	<b>ZA 4137-12</b>	<b>ZA 4137-72</b>
15 cm – 6"	<b>ZA 4137-15</b>	–

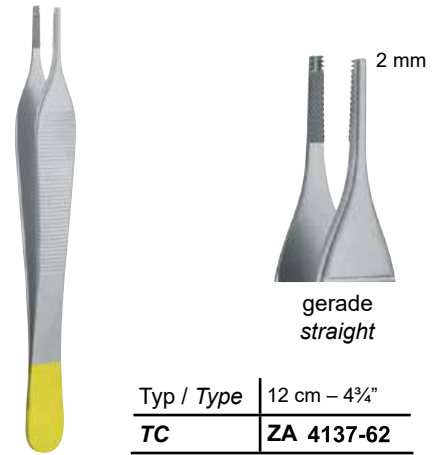
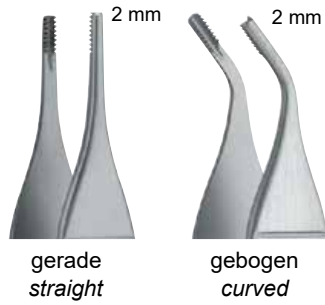

**ADSON-BROWN**

Typ / Type	12 cm – 4¾"
<b>TC</b>	<b>ZA 4137-62</b>



**COTTLE**

15 cm – 6"	<b>ZA 4026-15</b>
------------	-------------------

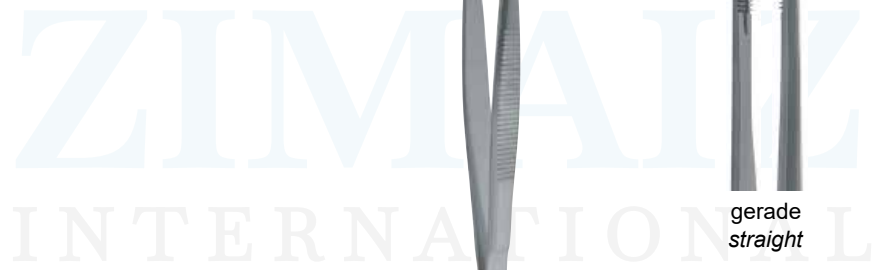

**BROWN**

15 cm – 6"	<b>ZA 4139-15</b>
20 cm – 6"	<b>ZA 4139-20</b>
25 cm – 10"	<b>ZA 4139-25</b>



**ADSON-GRAEFE**

12 cm – 4¾"	<b>ZA 4137-82</b>
-------------	-------------------



# Darm- und Lungenpinzetten Intestinal and Lung Forceps

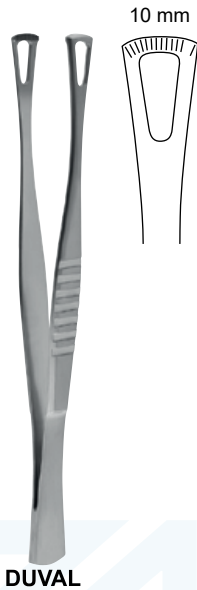

gerade  
straight

14,5 cm – 5¾"  
**ZA 4215-14**

**DUVAL**

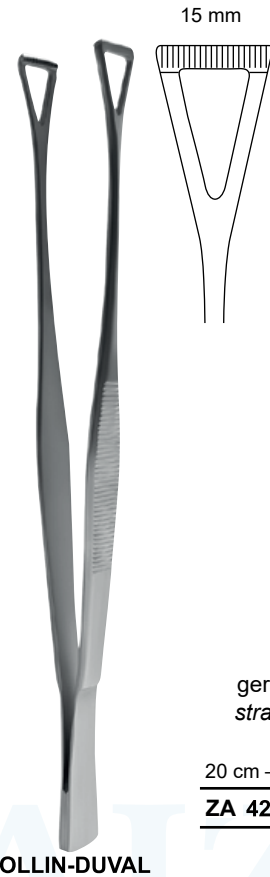

gerade  
straight

20 cm – 8"  
**ZA 4216-20**

**COLLIN-DUVAL**



7 mm

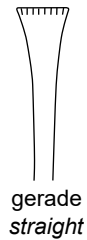

15 cm – 6"	<b>ZA 4235-15</b>
18 cm – 7"	<b>ZA 4235-18</b>
23 cm – 9"	<b>ZA 4235-23</b>

**NELSON**

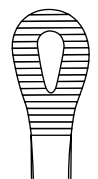

18 cm – 7"	<b>ZA 4236-18</b>
23 cm – 9"	<b>ZA 4236-23</b>

**SINGLEY-TUTTLE**



**DURANTE**



gerade  
straight

14,5 cm – 5¾"	<b>ZA 4219-14</b>
16 cm – 6¼"	<b>ZA 4219-16</b>
20 cm – 8"	<b>ZA 4219-20</b>



**RUSSISCHES MODELL  
RUSSIAN PATTERN**



gerade  
straight

15 cm – 6"	<b>ZA 4220-15</b>
20 cm – 8"	<b>ZA 4220-20</b>
25 cm – 10"	<b>ZA 4220-25</b>



**MAYO**



gerade  
straight

23 cm – 9"	<b>ZA 4221-23</b>
------------	-------------------



# Splitterpinzetten Splinter Forceps



gerade, glatt  
*straight, smooth*



gebogen, glatt  
*curved, smooth*



gerade  
*straight*



gebogen  
*curved*

8 cm – 3¼"	<b>ZA 4290-08</b>	<b>ZA 4291-08</b>	<b>ZA 4292-08</b>	<b>ZA 4293-08</b>
9 cm – 3½"	<b>ZA 4290-09</b>	<b>ZA 4291-09</b>	<b>ZA 4292-09</b>	<b>ZA 4293-09</b>
10,5 cm – 4¼"	<b>ZA 4290-10</b>	<b>ZA 4291-10</b>	<b>ZA 4292-10</b>	<b>ZA 4293-10</b>
11,5 cm – 4½"	<b>ZA 4290-11</b>	<b>ZA 4291-11</b>	<b>ZA 4292-11</b>	<b>ZA 4293-11</b>
12,5 cm – 5"	<b>ZA 4290-12</b>	<b>ZA 4291-12</b>	<b>ZA 4292-12</b>	<b>ZA 4293-12</b>
14,5 cm – 5¾"	–	–	<b>ZA 4270-05</b>	<b>ZA 4270-15</b>



**FEILCHENFELD**



gerade  
*straight*

7,5 cm – 3"	<b>ZA 4320-07</b>
9 cm – 3½"	<b>ZA 4320-09</b>
11,5 cm – 4½"	<b>ZA 4320-11</b>



**HUNTER**



gerade  
*straight*



gebogen  
*curved*

10,5 cm – 4¼"

<b>ZA 4340-10</b>	<b>ZA 4341-10</b>
-------------------	-------------------



**WALTER-CARMALT**



gerade  
*straight*



gebogen  
*curved*

10,5 cm – 4¼"

<b>ZA 4350-10</b>	<b>ZA 4351-10</b>
-------------------	-------------------

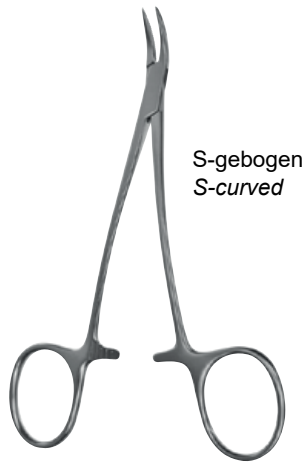

S-gebogen  
S-curved

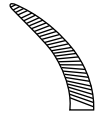

11 cm – 4¼"

**ZA 4358-11**

**PEET**



**STIEGLITZ**

gerade,  
ohne Sperre  
straight,  
without ratchet



gerade,  
mit Sperre  
straight, with  
ratchet



gebogen,  
ohne Sperre  
curved,  
without ratchet

gebogen,  
mit Sperre  
curved, with  
ratchet

13,5 cm – 5¼"

**ZA 4359-13**

**ZA 4360-13**

**ZA 4362-13**

**ZA 4361-13**



**RALK**

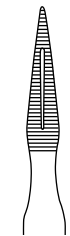

gerade  
straight

15 cm – 6"

**ZA 4364-15**



**RALK**

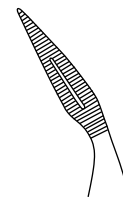

abgewinkelt 45°  
angled 45°

15 cm – 6"

**ZA 4365-15**



# Cilienpinzetten Cilia Forceps

