

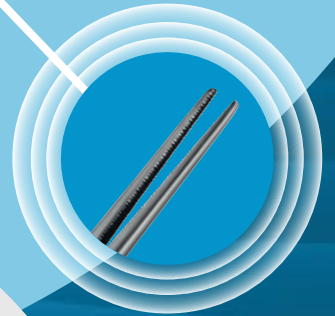

ZIMAIZ
INTERNATIONAL



Hemostatic Forceps

SURGICAL
INSTRUMENTS
CATALOGUE





Klemmen und Zangen Clamps and Forceps



Arterienklemmen	<i>Hemostatic forceps</i>	CF 1 - 25
Ligaturklemmen	<i>Ligature Forceps</i>	CF 26 - 39
Klemmzangen	<i>Clamp Forceps</i>	CF 40 - 41
Peritoneumklemmen	<i>Peritoneal Forceps</i>	CF 42 - 44
Tuchklemmen	<i>Towel Forceps</i>	CF 45 - 48
Schlauchklemmen	<i>Tubing Forceps</i>	CF 49 - 50
Kornzangen	<i>Dressing Forceps</i>	CF 51 - 53
Tupferzangen	<i>Cotton Swab Forceps</i>	CF 54 - 55
Schwammzangen	<i>Sponge Holding Forceps</i>	CF 56 - 57
Bulldogklemmen	<i>Bulldog Clamps</i>	CF 58 - 61





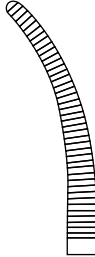

ZIMAIZ
INTERNATIONAL

Arterienklemmen Hemostatic Forceps



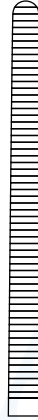

			
gerade straight	gebogen curved	gerade straight	gebogen curved
13 cm – 5"		14 cm – 5½"	
ZA 3000-13	ZA 3001-13	ZA 3000-14	ZA 3001-14

			
gerade straight	gebogen curved	gerade straight	gebogen curved
16 cm – 6¼"		18 cm – 7"	
ZA 3000-16	ZA 3001-16	ZA 3000-18	ZA 3001-18

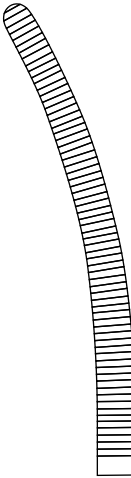

ROCHESTER-PEAN

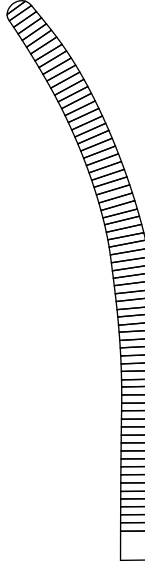
			
gerade straight	gebogen curved	gerade straight	gebogen curved
20 cm – 8"		22 cm – 8¾"	
ZA 3000-20	ZA 3001-20	ZA 3000-22	ZA 3001-22



Arterienklemmen Hemostatic Forceps



ROCHESTER-PEAN

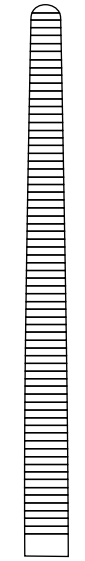

gerade
straight

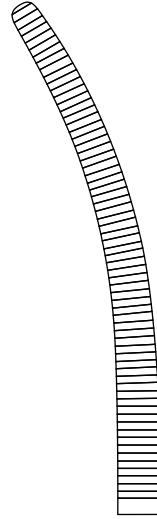

gebogen
curved



gerade
straight

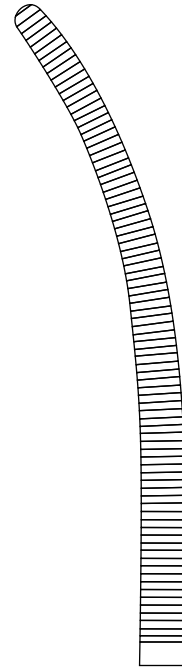

gebogen
curved

24 cm – 9½"

26 cm – 10¼"

ZA 3000-24

ZA 3001-24

ZA 3000-26

ZA 3001-26



ROCHESTER-PEAN



gerade
straight

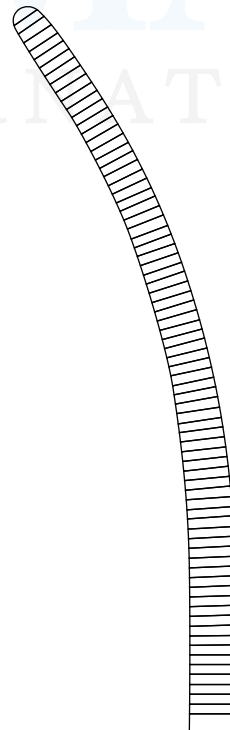

gebogen
curved

30 cm – 11¾"

ZA 3000-30

ZA 3001-30

Arterienklemmen Hemostatic Forceps

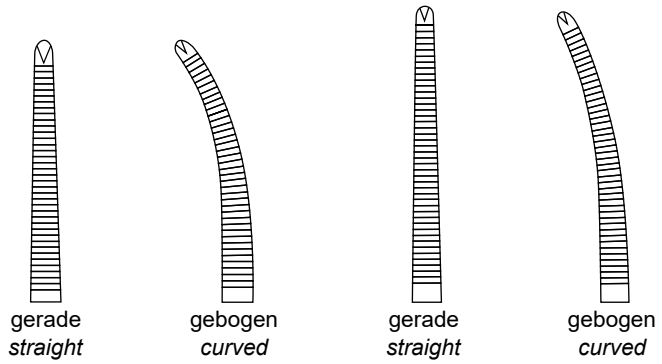

13 cm – 5"		14 cm – 5½"	
ZA 3010-13	ZA 3011-13	ZA 3010-14	ZA 3011-14



OCHSNER-KOCHER

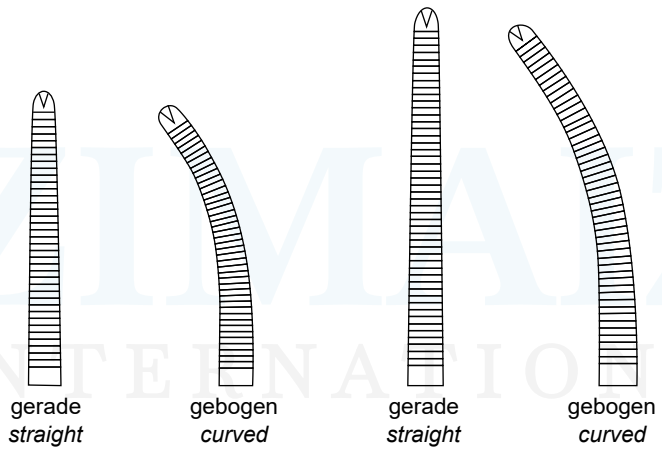

16 cm – 6¼"		18 cm – 7"	
ZA 3010-16	ZA 3011-16	ZA 3010-18	ZA 3011-18



Arterienklemmen Hemostatic Forceps

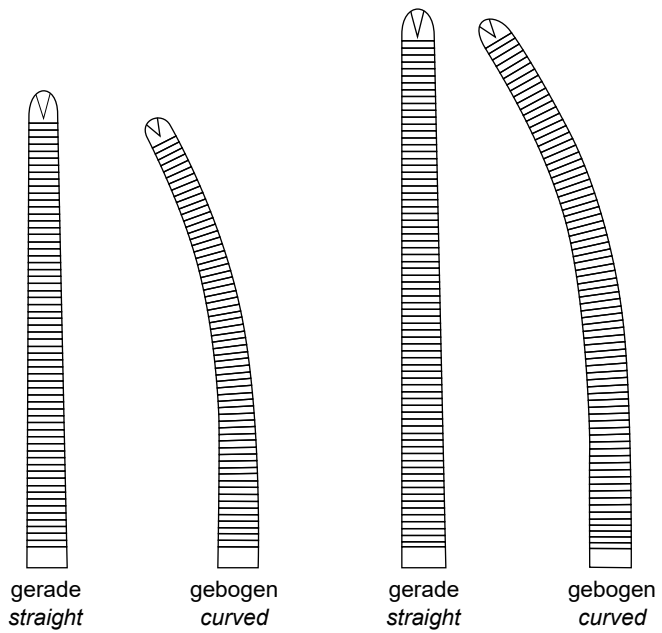

20 cm – 8"		22 cm – 8¾"	
ZA 3010-20	ZA 3011-20	ZA 3010-22	ZA 3011-22

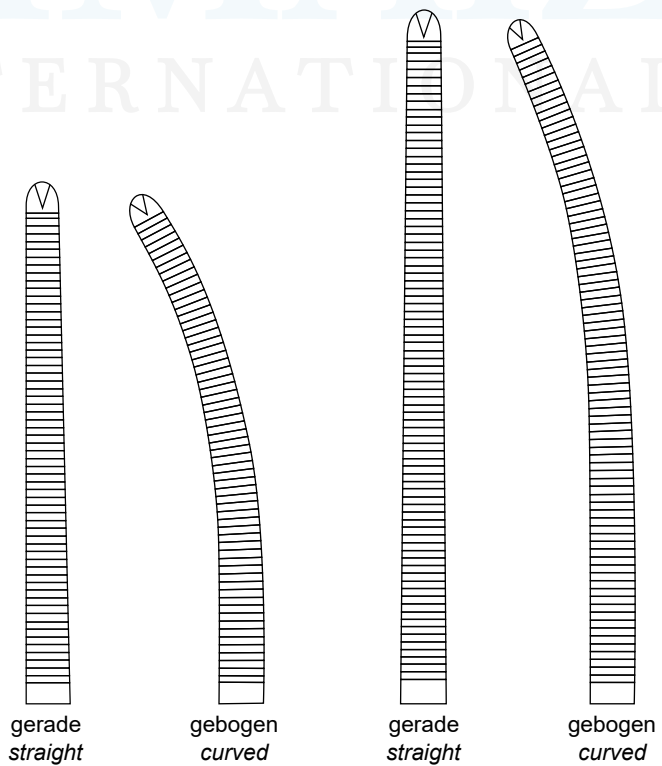

24 cm – 9½"		26 cm – 10¼"	
ZA 3010-24	ZA 3011-24	ZA 3010-26	ZA 3011-26

Arterienklemmen Hemostatic Forceps



gerade
straight

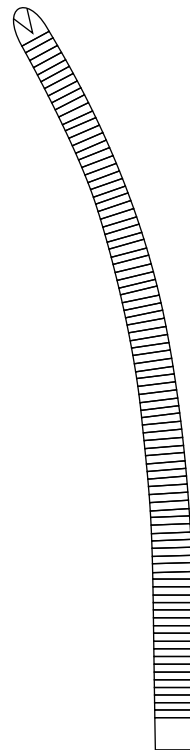

gebogen
curved

30 cm – 11¾"

ZA 3010-30

ZA 3011-30





ZIMAIZ
INTERNATIONAL



Arterienklemmen Hemostatic Forceps

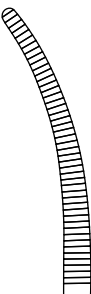

PEAN

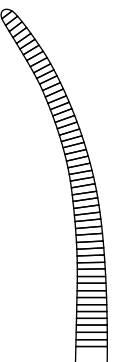



					
gerade straight	gebogen curved	gerade straight	gebogen curved	gerade straight	gebogen curved
13 cm – 5"		14 cm – 5½"		16 cm – 6¼"	
ZA 3020-13	ZA 3021-13	ZA 3020-14	ZA 3021-14	ZA 3020-16	ZA 3021-16



KOCHER

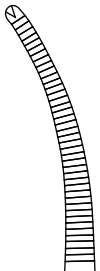

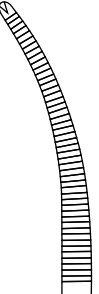
 1 : 2 Zähne
 1 : 2 teeth

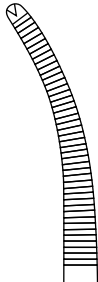
					
gerade straight	gebogen curved	gerade straight	gebogen curved	gerade straight	gebogen curved
13 cm – 5"		14 cm – 5½"		16 cm – 6¼"	
ZA 3030-13	ZA 3031-13	ZA 3030-14	ZA 3031-14	ZA 3030-16	ZA 3031-16

Arterienklemmen Hemostatic Forceps



KELLY

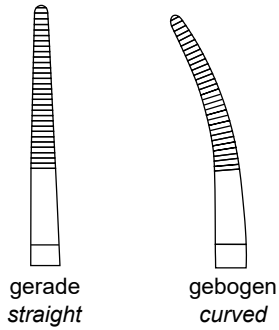

14,5 cm – 5¾"

ZA 3050-14	ZA 3051-14
-------------------	-------------------



ZIMAIZ
INTERNATIONAL



KELLY-RANKIN

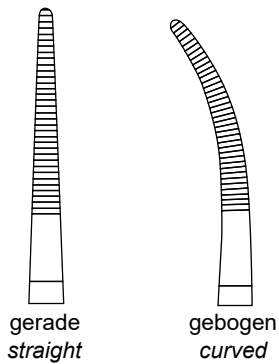

16 cm – 6¼"

ZA 3050-16	ZA 3051-16
-------------------	-------------------



Arterienklemmen Hemostatic Forceps



CRILE

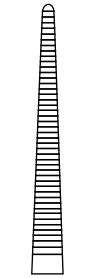

gerade
straight



gebogen
curved

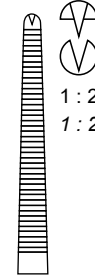

gerade
straight

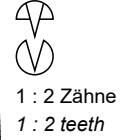

1 : 2 Zähne
1 : 2 teeth

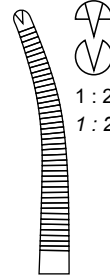

gebogen
curved

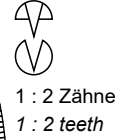

1 : 2 Zähne
1 : 2 teeth

14,5 cm – 5¾"

ZA 3070-14	ZA 3071-14	ZA 3074-14	ZA 3075-14
------------	------------	------------	------------



CRILE-RANKIN

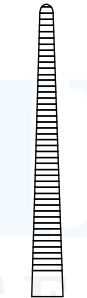

gerade
straight



gebogen
curved



gerade
straight



1 : 2 Zähne
1 : 2 teeth

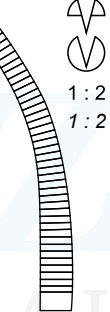

gebogen
curved

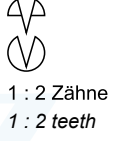

1 : 2 Zähne
1 : 2 teeth

16 cm – 6¼"

ZA 3070-16	ZA 3071-16	ZA 3074-16	ZA 3075-16
------------	------------	------------	------------



BABY-CRILE

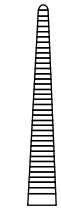

gerade
straight

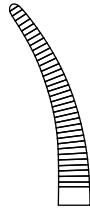

gebogen
curved

14,5 cm – 5¾"

ZA 3072-14	ZA 3073-14
------------	------------

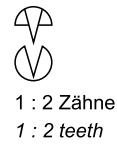

1 : 2 Zähne
1 : 2 teeth



gerade
straight



gebogen
curved

14,5 cm – 5¾"

ZA 3076-14	ZA 3077-14
------------	------------

Arterienklemmen Hemostatic Forceps



COLLER-CRILE

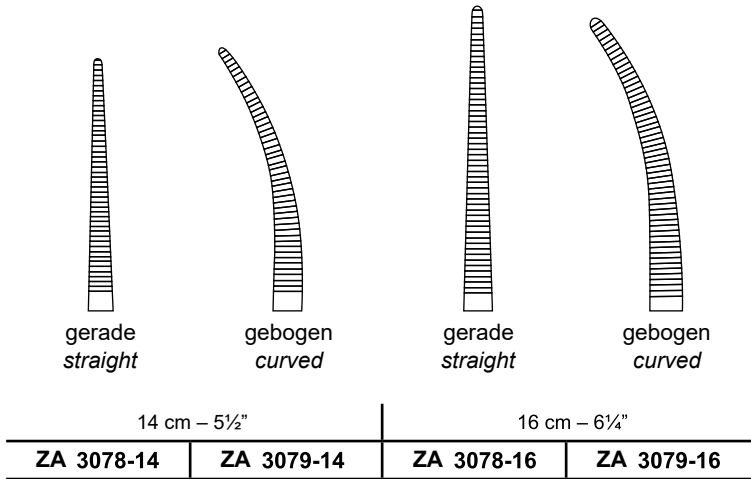

COLLER-CRILE



LERICHE

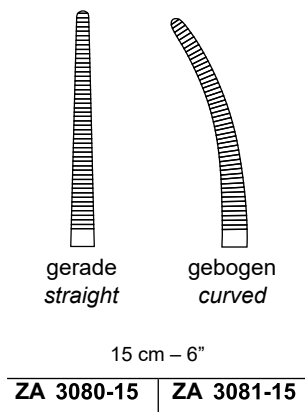

LERICHE

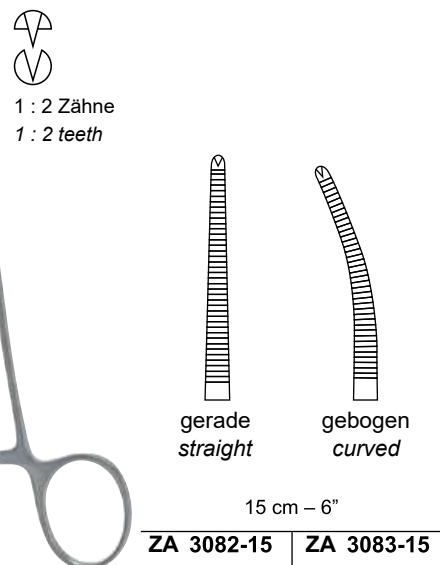



Arterienklemmen Hemostatic Forceps



PROVIDENCE



gerade
straight



gebogen
curved

14,5 cm – 5¾"

ZA 3090-14 | **ZA 3091-14**



Ligaturklemme
Ligature forceps



gerade, glatt
straight, smooth

9,5 cm – 3¾"

ZA 3097-09



HALSTED-MOSQUITO



gerade
straight

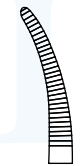

gebogen
curved

12,5 cm – 5"

ZA 3100-12 | **ZA 3101-12**



HALSTED-MOSQUITO



1 : 2 Zähne
1 : 2 teeth

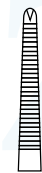

gerade
straight



gebogen
curved

12,5 cm – 5"

ZA 3110-12 | **ZA 3111-12**



HALSTED-MOSQUITO



gerade
straight

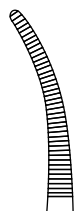

gebogen
curved

14 cm – 5½"

ZA 3100-14 | **ZA 3101-14**



HALSTED-MOSQUITO



1 : 2 Zähne
1 : 2 teeth



gerade
straight

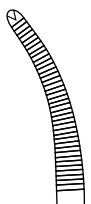

gebogen
curved

14 cm – 5½"

ZA 3110-14 | **ZA 3111-14**

Arterienklemmen Hemostatic Forceps



HALSTED-MOSQUITO

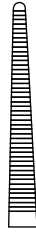

gerade
straight



gebogen
curved

18 cm – 7"

ZA 3100-18

ZA 3101-18



gerade
straight

1 : 2 Zähne
1 : 2 teeth



gebogen
curved

1 : 2 Zähne
1 : 2 teeth

18 cm – 7"

ZA 3110-18

ZA 3111-18



ZIMAIZ
INTERNATIONAL



HALSTED-MOSQUITO



gerade
straight

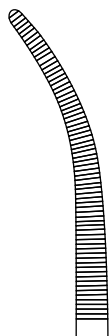

gebogen
curved

21 cm – 8¼"

ZA 3100-21

ZA 3101-21



gerade
straight

1 : 2 Zähne
1 : 2 teeth



gebogen
curved

1 : 2 Zähne
1 : 2 teeth

21 cm – 8¼"

ZA 3110-21

ZA 3111-21



Arterienklemmen Hemostatic Forceps



JACOBSON

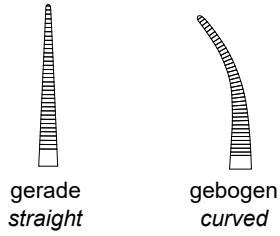

gerade
straight

gebogen
curved

13 cm – 5"

ZA 3114-13	ZA 3115-13
-------------------	-------------------



MICRO-MOSQUITO

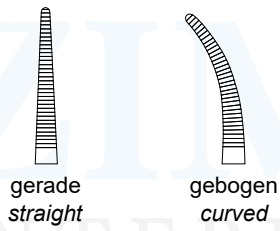

gerade
straight

gebogen
curved

10 cm – 4"

ZA 3120-10	ZA 3121-10
-------------------	-------------------

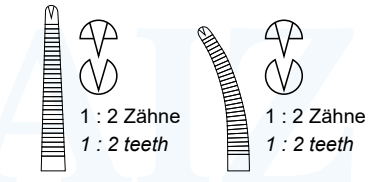

gerade
straight
1 : 2 Zähne
1 : 2 teeth

gebogen
curved
1 : 2 Zähne
1 : 2 teeth

10 cm – 4"

ZA 3122-10	ZA 3123-10
-------------------	-------------------

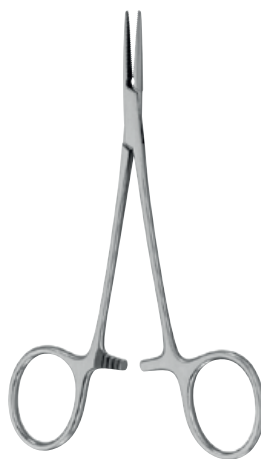

MICRO-MOSQUITO

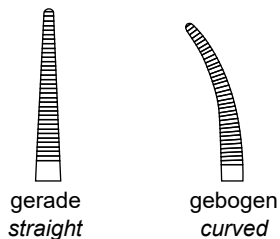

gerade
straight

gebogen
curved

12,5 cm – 5"

ZA 3120-12	ZA 3121-12
-------------------	-------------------

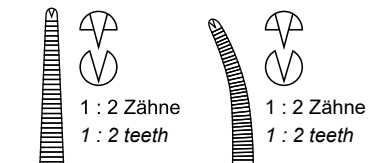

gerade
straight
1 : 2 Zähne
1 : 2 teeth

gebogen
curved
1 : 2 Zähne
1 : 2 teeth

12,5 cm – 5"

ZA 3122-12	ZA 3123-12
-------------------	-------------------

Arterienklemmen Hemostatic Forceps

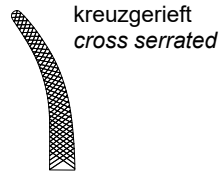

kreuzgerieft
cross serrated

gebogen
curved

12 cm – 4¾"

ZA 3137-12



HARTMANN



gerade
straight



gebogen
curved

10 cm – 4"

ZA 3140-10

ZA 3141-10

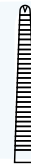

gerade
straight

1 : 2 Zähne
1 : 2 teeth



gebogen
curved

1 : 2 Zähne
1 : 2 teeth

10 cm – 4"

ZA 3142-10

ZA 3143-10



CARREL



gerade
straight

10 cm – 4"

ZA 3147-10



CHAPUT

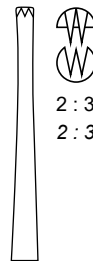

gerade
straight

2 : 3 Zähne
2 : 3 teeth

13 cm – 5"

ZA 3148-13



Arterienklemmen Hemostatic Forceps



TUFFIER



gerade
straight

13 cm – 5"

ZA 3149-13



PENNINGTON



gerade
straight

15 cm – 6"

ZA 3152-15



gebogen
curved

20 cm – 8"

ZA 3152-20



PEAN

kurzfassende Maulteile
short gripping jaws



gerade
straight

14 cm – 5½"

ZA 3153-14



gerade
straight

16 cm – 6¼"

ZA 3153-16



COLLIN



gerade
straight

15,5 cm – 6"

ZA 3155-16



COLLIN



gerade
straight

14 cm – 5½"

ZA 3156-14



COLLIN



gerade
straight

16,5 cm – 6½"

ZA 3157-16



DUNHILL



gebogen
curved

13 cm – 5"

ZA 3159-13



Arterienklemmen Hemostatic Forceps



CAIRNS



gerade
straight



gebogen
curved

15 cm – 6"

ZA 3162-15

ZA 3163-15



MOYNIHAN



seitlich gebogen
curved sideways

13,5 cm – 5¼"

ZA 3164-01



ZIMAIZ
INTERNATIONAL



MOYNIHAN



gebogen
curved

15 cm – 6"

ZA 3164-02

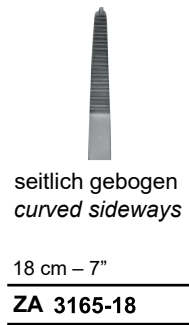

RAIMONDI



ZIMAIZ
INTERNATIONAL

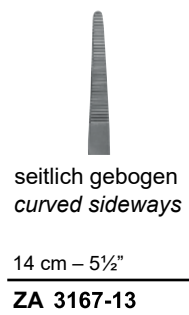

HOEN



Arterienklemmen Hemostatic Forceps



ROCHESTER-CARMALT

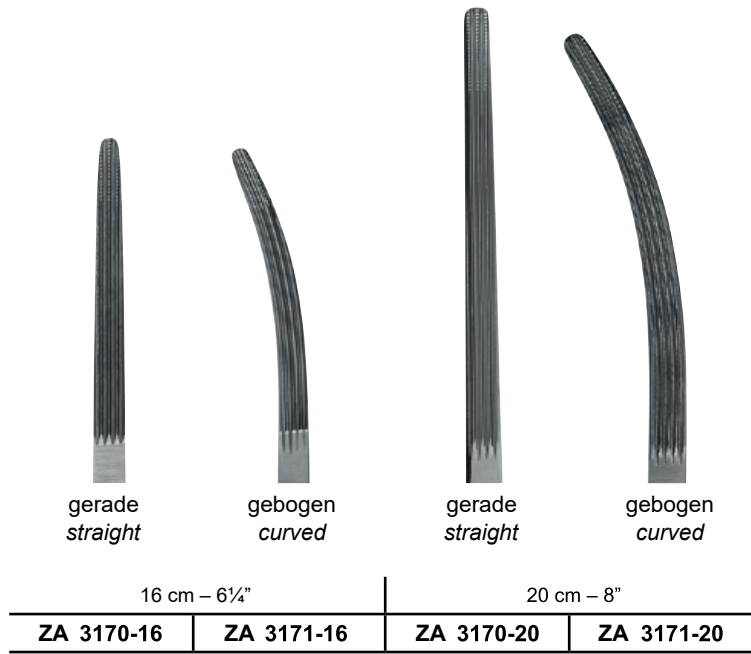

MOSQUITO-DANDY

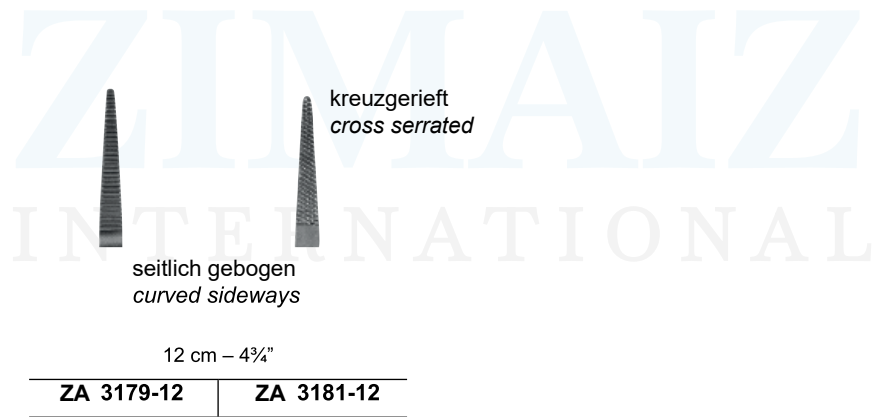

DANDY

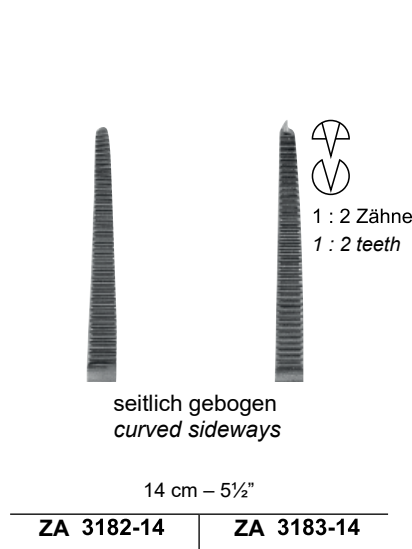

Arterienklemmen Hemostatic Forceps



15,5 cm – 6"
ZA 3185-15

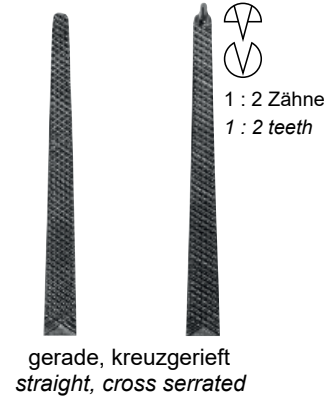

16 cm – 6 1/4"
ZA 3186-16 | **ZA 3187-16**



ZIMAIZ
INTERNATIONAL



15 cm – 6"		18 cm – 7"	
ZA 3190-15	ZA 3191-15	ZA 3190-18	ZA 3191-18



Arterienklemmen Hemostatic Forceps



FUCHSIG



gebogen
curved

19 cm – 7½"

ZA 3198-19



ADSON



gerade
straight



gebogen
curved

18,5 cm – 7¼"

ZA 3200-18

ZA 3201-18



NISSEN



gebogen
curved

18,5 cm – 7¼"

ZA 3204-18



22 cm – 8¾"

ZA 3204-22



BABY-ADSON



leicht gebogen
slightly curved

14 cm – 5½"

ZA 3205-14



stark gebogen
strongly curved

18 cm – 7"

ZA 3205-18

Arterienklemmen Hemostatic Forceps



gerade
straight



gebogen
curved

20 cm – 8"

ZA 3240-20

ZA 3241-20



gerade
straight



gebogen
curved

22 cm – 8¾"

ZA 3240-22

ZA 3241-22



kreuzgerieft
cross serrated

BENGOLEA



gerade
straight



gebogen
curved

24 cm – 9½"

ZA 3240-24

ZA 3241-24



gerade
straight



gebogen
curved

26 cm – 10¼"

ZA 3240-26

ZA 3241-26



Arterienklemmen Hemostatic Forceps



BIRKETT

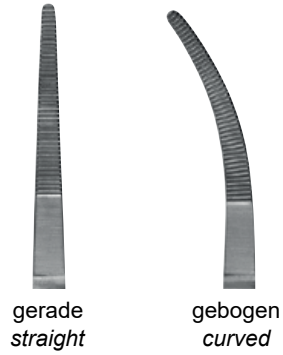

gerade
straight

gebogen
curved

19 cm – 7½"

ZA 3210-19

ZA 3211-19



ZIMAIZ
INTERNATIONAL



ROBERTS

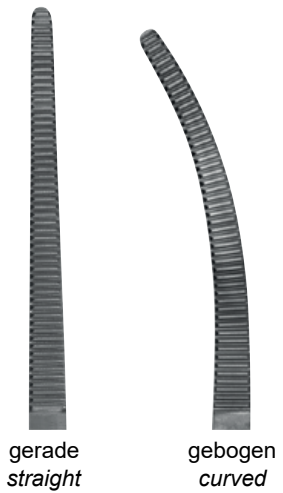

gerade
straight

gebogen
curved

22 cm – 8¾"

ZA 3250-22

ZA 3251-22

Arterienklemmen Hemostatic Forceps

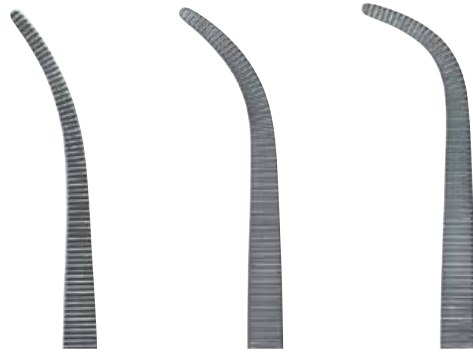

gebogen
curved

leicht gebogen
slightly curved

stark gebogen
strongly curved

19 cm – 7½"

ZA 3253-41	ZA 3253-42	ZA 3253-43
-------------------	-------------------	-------------------



gebogen
curved

leicht gebogen
slightly curved

stark gebogen
strongly curved

22 cm – 8¾"

ZA 3253-61	ZA 3253-62	ZA 3253-63
-------------------	-------------------	-------------------



gebogen
curved

leicht gebogen
slightly curved

stark gebogen
strongly curved

24 cm – 9½"

ZA 3253-71	ZA 3253-72	ZA 3253-73
-------------------	-------------------	-------------------



KELLY



Arterienklemmen Hemostatic Forceps



SAROT

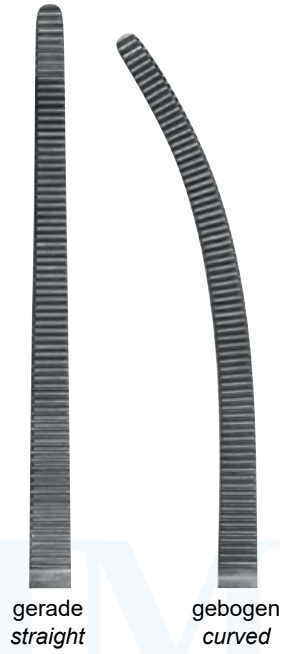

gerade
straight

gebogen
curved

24 cm – 9½"

ZA 3270-24

ZA 3271-24

Arterienklemmen Hemostatic Forceps



CRAFOORD

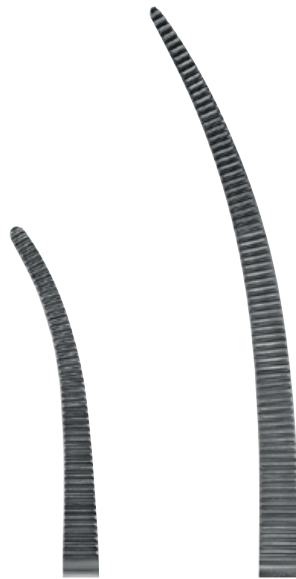

gebogen
curved

18 cm – 7"	24 cm – 9½"
ZA 3275-18	ZA 3275-24



Ligaturklemme
Ligature forceps

KANTROWITZ



gebogen
curved

stark gebogen
strongly curved

stark gebogen
strongly curved

19 cm – 7½"	24 cm – 9½"	26,5 cm – 10½"
ZA 3279-19	ZA 3279-24	ZA 3279-26

ZIMAIZ
INTERNATIONAL



Ligaturklemmen
Ligature Forceps



JOHNS-HOPKINS



gebogen
curved

20 cm – 8"

ZA 3285-20



RUMEL



gebogen
curved



gebogen
curved



gebogen
curved



gebogen
curved



gebogen
curved

23 cm – 9"

ZA 3280-01	ZA 3280-02	ZA 3280-03	ZA 3280-04	ZA 3280-05
-------------------	-------------------	-------------------	-------------------	-------------------



ZENKER



gerade
straight

leicht gebogen
slightly curved

stark gebogen
strongly curved

29,5 cm – 11½"

ZA 3286-00	ZA 3286-01	ZA 3286-02
------------	------------	------------



BABY-OVERHOLT



gebogen
curved

13,5 cm – 5¼"

ZA 3289-14



Ligaturklemmen Ligature Forceps

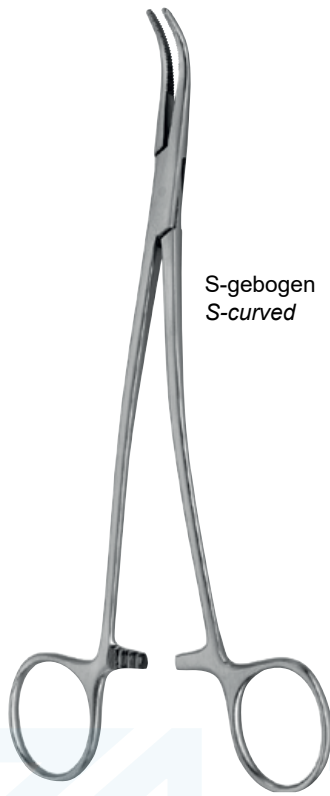

18,5 cm – 7¼"	20,5 cm – 8"	21 cm – 8¼"	21,5 cm – 8½"
ZA 3290-21	ZA 3290-22	ZA 3290-23	ZA 3290-24

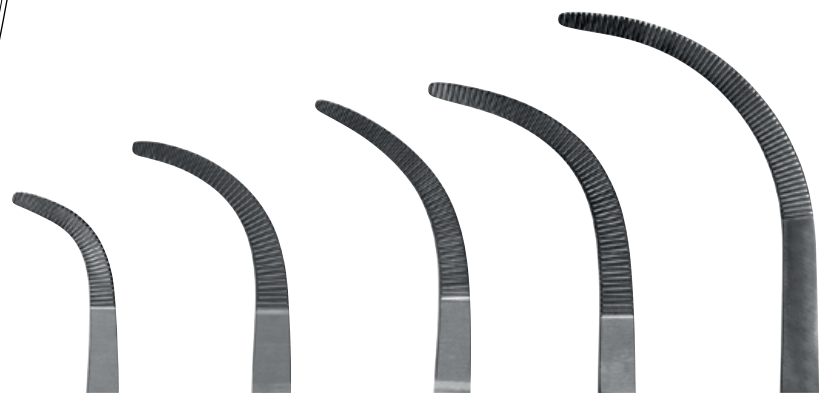
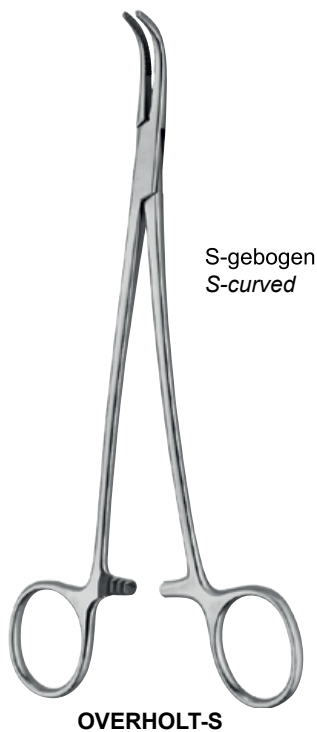

18,5 cm – 7¼"	20,5 cm – 8"	21 cm – 8¼"	21,5 cm – 8½"	24 cm – 9½"
ZA 3290-01	ZA 3290-02	ZA 3290-03	ZA 3290-04	ZA 3290-05

Ligaturklemmen Ligature Forceps

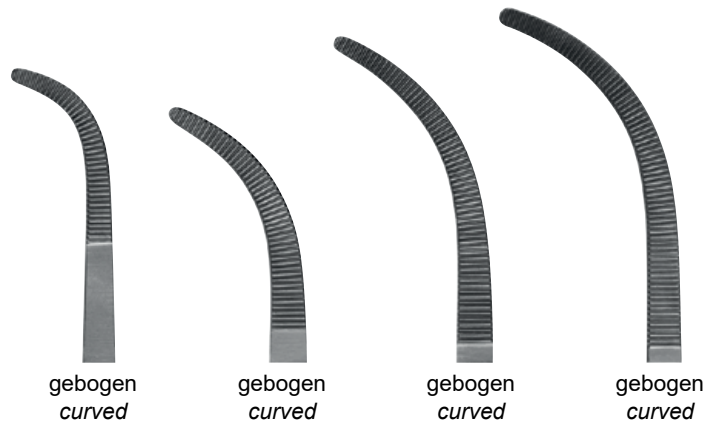

21 cm – 8¼"

ZA 3291-21	ZA 3292-21	ZA 3293-21	ZA 3294-21
------------	------------	------------	------------



OVERHOLT-GEISSENDÖRFER

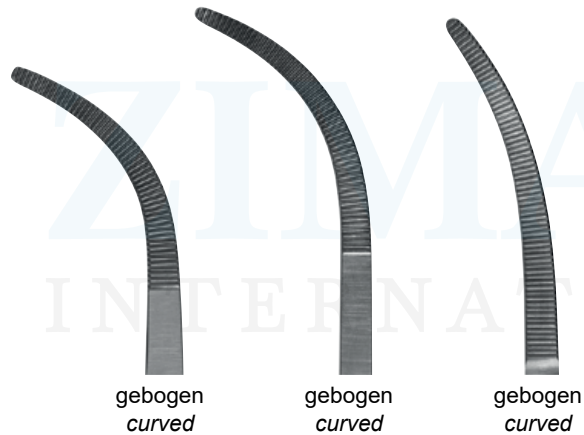

21 cm – 8¼"

ZA 3295-21	ZA 3296-21	ZA 3297-21
------------	------------	------------



Ligaturklemmen Ligature Forceps



OVERHOLT-GEISSENDÖRFER

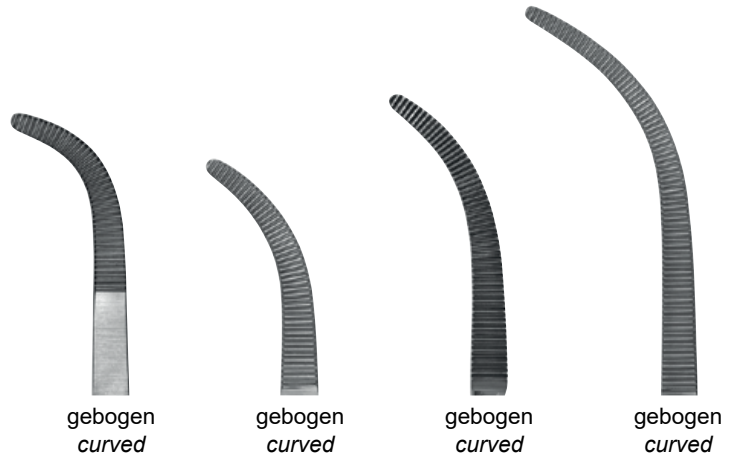

27 cm – 10½"

ZA 3291-27	ZA 3292-27	ZA 3293-27	ZA 3294-27
-------------------	-------------------	-------------------	-------------------

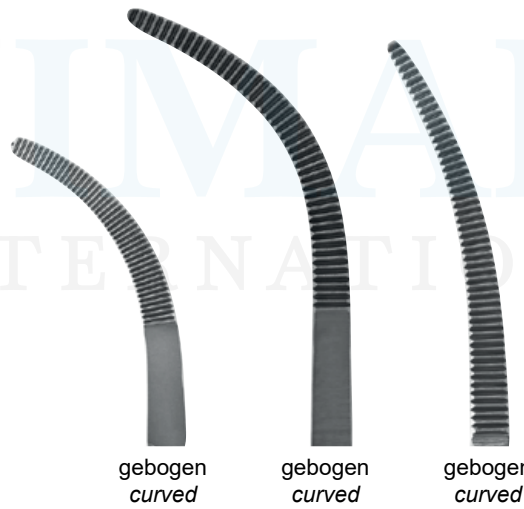

27 cm – 10½"

ZA 3295-27	ZA 3296-27	ZA 3297-27
-------------------	-------------------	-------------------



OVERHOLT-MIXTER



gebogen
curved

21 cm – 8¼"

ZA 3298-21

ZIMAIZ
INTERNATIONAL



HEISS



gerade
straight



leicht gebogen
slightly curved



stark gebogen
strongly curved

20 cm – 8"

ZA 3301-20

ZA 3302-20

ZA 3303-20



1 : 2 Zähne
1 : 2 *teeth*



gerade
straight



gebogen
curved

20 cm – 8"

ZA 3305-20

ZA 3306-20



Ligaturklemmen Ligature Forceps



MEEKER



gebogen
curved

27 cm – 10½"

ZA 3308-27



LOWER



gebogen
curved

18 cm – 7"

ZA 3325-18

Ligaturklemmen Ligature Forceps

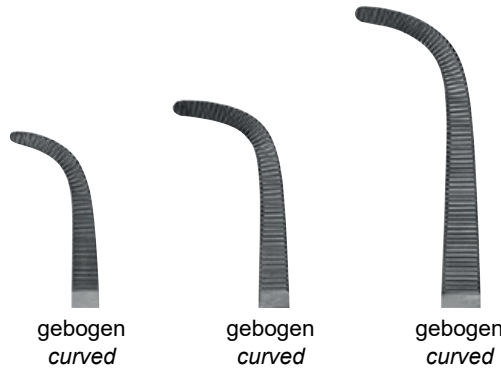

13 cm – 5"	18 cm – 7"	20 cm – 8"
ZA 3326-13	ZA 3326-18	ZA 3326-20



GEMINI



23 cm – 9"	25 cm – 10"	27 cm – 10½"
ZA 3326-23	ZA 3326-25	ZA 3326-27



Ligaturklemmen
Ligature Forceps



MINI-GEMINI

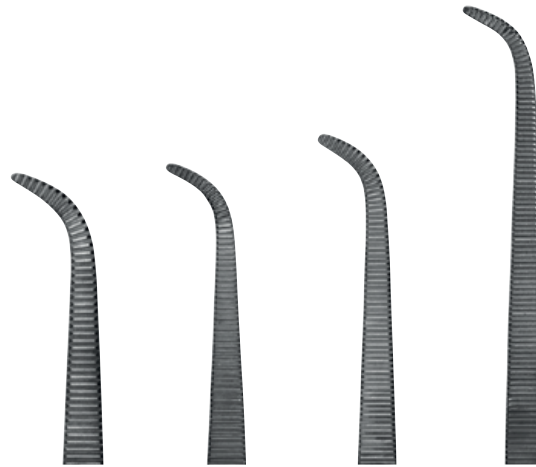

gebogen
curved

18 cm – 7"	22 cm – 8¾"	25 cm – 10"	28 cm – 11"
ZA 3327-18	ZA 3327-22	ZA 3327-25	ZA 3327-28



BABY-MIXTER



gebogen
curved

14 cm – 5½"	14 cm – 5½"	18 cm – 7"
ZA 3328-01	ZA 3328-14	ZA 3328-18



Präparierklemme
Dissecting forceps



SAWTELL



gebogen
curved

18 cm – 7"

ZA 3329-01



MIXTER



15 cm – 6"

ZA 3330-15



gebogen
curved

19 cm – 7½"

ZA 3330-19

INTERNATIONAL



O'SHAUGHNESSY



15,5 cm – 6"

ZA 3335-15



gebogen
curved

19 cm – 7½"

ZA 3335-19



Ligaturklemmen Ligature Forceps



MIXTER-SLIM



gebogen
curved

18 cm – 7"	23 cm – 9"
ZA 3336-18	ZA 3336-23



MIXTER



gebogen
curved

gebogen
curved

gebogen
curved

22 cm – 8 $\frac{3}{4}$ "	25 cm – 10"	28 cm – 11"
ZA 3341-22	ZA 3342-25	ZA 3343-28



MIXTER



gebogen
curved

22 cm – 8 $\frac{3}{4}$ "

ZA 3350-22



WICKSTROEM



gebogen
curved

20 cm – 8"

ZA 3351-20



FINOCCHIETTO



gebogen
curved

24 cm – 9 $\frac{1}{2}$ "

ZA 3352-24



Ligaturklemmen Ligature Forceps

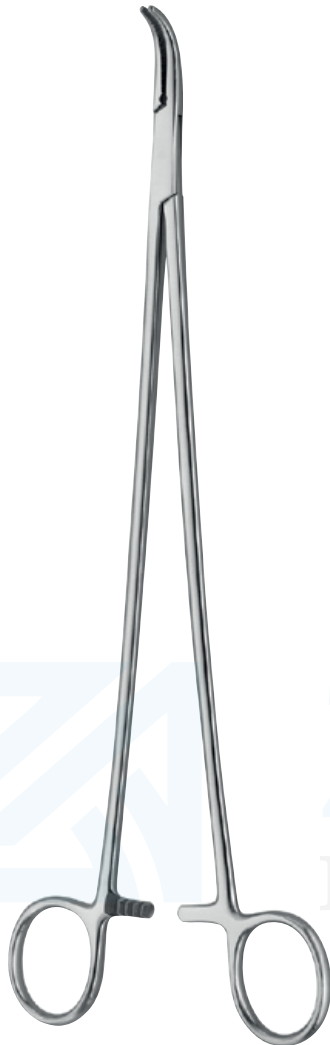

LAWRENCE



gebogen
curved

27,5 cm – 10¾"

ZA 3355-27



LAHEY



gebogen
curved

19 cm – 7½"

ZA 3361-19

23 cm – 9"

ZA 3361-23

Ligaturklemmen Ligature Forceps



gerade
straight



gerade
straight



gerade
straight



gerade
straight



gerade
straight

13 cm – 5"	14 cm – 5½"	15 cm – 6"	18 cm – 7"	20 cm – 8"
ZA 3380-13	ZA 3380-14	ZA 3380-15	ZA 3380-18	ZA 3380-20



SPENCER-WELLS



gebogen
curved



gebogen
curved



gebogen
curved



gebogen
curved



gebogen
curved

13 cm – 5"	14 cm – 5½"	15 cm – 6"	18 cm – 7"	20 cm – 8"
ZA 3381-13	ZA 3381-14	ZA 3381-15	ZA 3381-18	ZA 3381-20



Klemmzangen Clamp Forceps

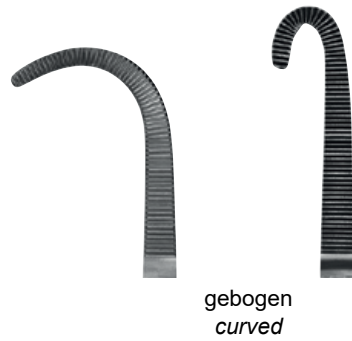

19 cm – 7½"

ZA 3387-01	ZA 3387-02
-------------------	-------------------

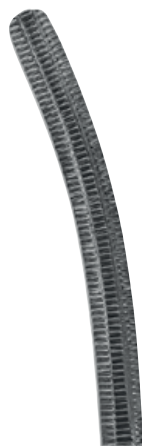

21 cm – 8¼"

ZA 3392-21



1 : 2 Zähne
1 : 2 teeth



20,5 cm – 8"

ZA 3394-20

25 cm – 10"

ZA 3394-25



FAURE



gebogen
curved

25 cm – 10"

ZA 3433-45

ZIMAIZ
INTERNATIONAL



Peritoneumklemmen Peritoneal Forceps



WERTHEIM



gebogen
curved

18 cm – 7"

ZA 3438-18



BABY-MIKULICZ



1 : 2 Zähne
1 : 2 teeth

gebogen
curved

14 cm – 5½"

ZA 3492-14

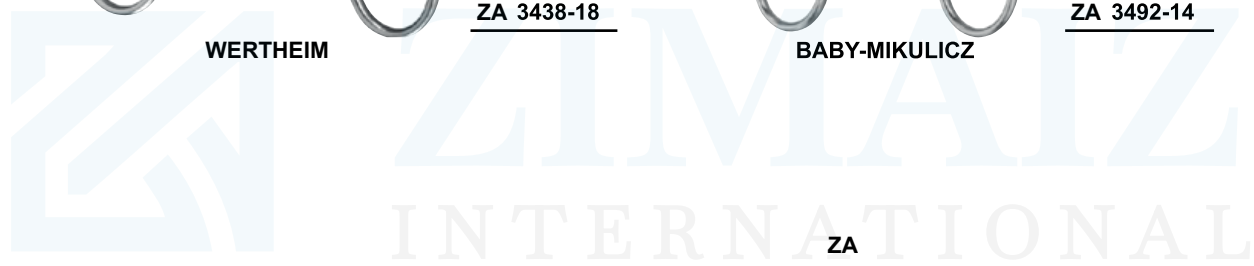

BABY-MIKULICZ



1 : 2 Zähne
1 : 2 teeth

gebogen
curved

18,5 cm – 7¼"

ZA 3499-18



MIKULICZ



1 : 2 Zähne
1 : 2 teeth



gebogen
curved

18 cm – 7"

ZA 3500-18

20 cm – 8"

ZA 3500-20

Peritoneumklemmen Peritoneal Forceps



MIKULICZ



1 : 2 Zähne
1 : 2 teeth

gebogen
curved

20 cm – 8"

ZA 3501-20



MIKULICZ



1 : 2 Zähne
1 : 2 teeth

seitlich gebogen
curved sideways

18,5 cm – 7 1/4"

ZA 3502-18



MIKULICZ



1 : 2 Zähne
1 : 2 teeth

gebogen
curved

18 cm – 7"

ZA 3504-18



MIKULICZ



1 : 2 Zähne
1 : 2 teeth



gebogen
curved

20 cm – 8"

ZA 3505-20



gebogen
curved

20 cm – 8"

ZA 3506-20



Peritoneumklemmen Peritoneal Forceps



1 : 2 Zähne
1 : 2 *teeth*



leicht gebogen
slightly curved



gebogen
curved

20 cm – 8"

ZA 3511-20

ZA 3512-20

FAURE



ZIMAIZ
INTERNATIONAL

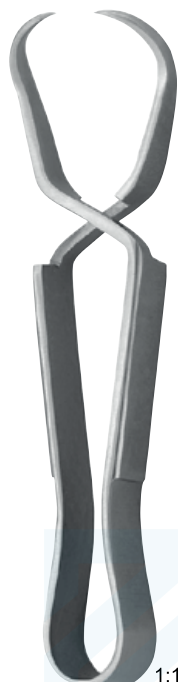

SCHADEL

1:1

gebogen
curved

9 cm – 3½"

ZA 3550-09



JONES

1:1

gebogen
curved

6 cm – 2½"

ZA 3552-05



JONES

1:1

gebogen
curved

9 cm – 3½"

ZA 3552-09



ENGLISCHES MODELL
ENGLISH PATTERN

1:1

gebogen
curved

9 cm – 3½"

ZA 3553-09



Tuchklemmen Towel Forceps



BACKHAUS

9 cm – 3½"	ZA 3600-09
11 cm – 4¼"	ZA 3600-11
13 cm – 5"	ZA 3600-13
15 cm – 6"	ZA 3600-15



Tuchklemme
mit Schlauch-
oder Kabelhalter
*Towel forceps
with clip for tubing or
cable*

11 cm – 4¼"	ZA 3602-11
13 cm – 5"	ZA 3602-13



PEERS-BERTRAM

14,5 cm – 5¾"	ZA 3604-14
---------------	-------------------





TOHOKU

10 cm – 4"	ZA 3605-10
13 cm – 5"	ZA 3605-13



Tuchklemme
für Papiertücher
*Towel forceps
for paper tissues*

11 cm – 4¼"	ZA 3617-11
14 cm – 5½"	ZA 3617-13



LORNA

10 cm – 4"	ZA 3618-10
13 cm – 5"	ZA 3618-13





Tuchklemmen
Towel Forceps



BERNHARD



16,5 cm – 6½"
ZA 3620-16



ZIMAIZ
INTERNATIONAL



LANE



13 cm – 5"
ZA 3622-13



15,5 cm – 6"
ZA 3622-15



20 cm – 8"
ZA 3622-20



15 cm – 6"	18 cm – 7"	20 cm – 8"
ZA 3680-15	ZA 3680-18	ZA 3680-20



ZIMAIZ
INTERNATIONAL



14,5 cm – 5¾"
ZA 3682-14



glatt
smooth

16,5 cm – 6½"	18 cm – 7"
ZA 3684-16	ZA 3684-18



Schlauchklemmen Tubing Forceps



Schlauchklemme
mit Schutzbügel
*Tubing forceps with
safety guard*



15 cm – 6"	18 cm – 7"	20 cm – 8"
ZA 3686-15	ZA 3686-18	ZA 3686-20

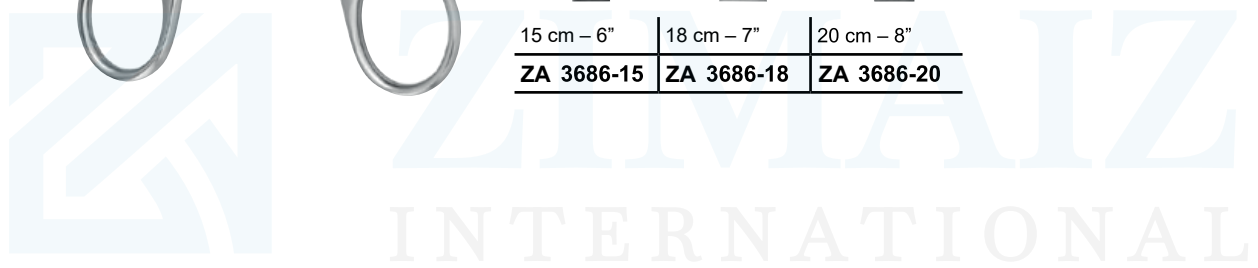







1:1
HOFFMANN

max. Schlauch-Durchmesser- max. tubing diameter	
8 mm	ZA 3692-13
10 mm	ZA 3692-17
12 mm	ZA 3692-20
15 mm	ZA 3692-25
18 mm	ZA 3692-30
25 mm	ZA 3692-40

Kornzangen Dressing Forceps



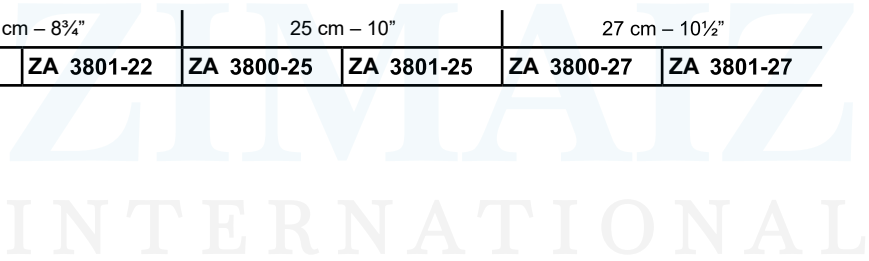

ULRICH

					
gerade straight	gebogen curved	gerade straight	gebogen curved	gerade straight	gebogen curved
22 cm – 8¾"		25 cm – 10"		27 cm – 10½"	
ZA 3800-22	ZA 3801-22	ZA 3800-25	ZA 3801-25	ZA 3800-27	ZA 3801-27



LISTER

Sinusklemme
Sinus forceps

		
gerade straight	gerade straight	gerade straight
12,5 cm – 5"	16 cm – 6¼"	18 cm – 7"
ZA 3810-12	ZA 3810-16	ZA 3810-18

Korn-(Polypen) Zange
Dressing and polypus forceps

	
	gebogen curved
	13 cm – 5"
	ZA 3812-13

BRYANT



Kornzangen Dressing Forceps



GROSS-MAIER



mit Sperre
with ratchet

ohne Sperre
without ratchet

gerade- straight	gebogen- curved	gerade- straight	gebogen- curved
20 cm – 8"		20 cm – 8"	
ZA 3860-20	ZA 3861-20	ZA 3862-20	ZA 3863-20



GROSS-MAIER

1:3



mit Sperre
with ratchet

ohne Sperre
without ratchet

gerade- straight	gebogen- curved	gerade- straight	gebogen- curved
25 cm – 10"		25 cm – 10"	
ZA 3860-25	ZA 3861-25	ZA 3862-25	ZA 3863-25



PELKMANN

1:3



gerade
straight

gebogen
curved

25 cm – 10"

ZA 3872-25

ZA 3873-25



SIMS-MAIER

1:3



gerade
straight

gebogen
curved

28 cm – 11"

ZA 3874-28

ZA 3875-28



Tupferzangen Cotton Swab Forceps



COLLIN



gerade
straight

25 cm – 10"

ZA 3887-25



CHERON



gebogen
curved

25 cm – 10"

ZA 3888-25



EMMET



gerade
straight

21 cm – 8¼"

ZA 3889-21



BOZEMANN



gerade
straight

26 cm – 10¼"

ZA 3890-26

ZIMAIZ
INTERNATIONAL

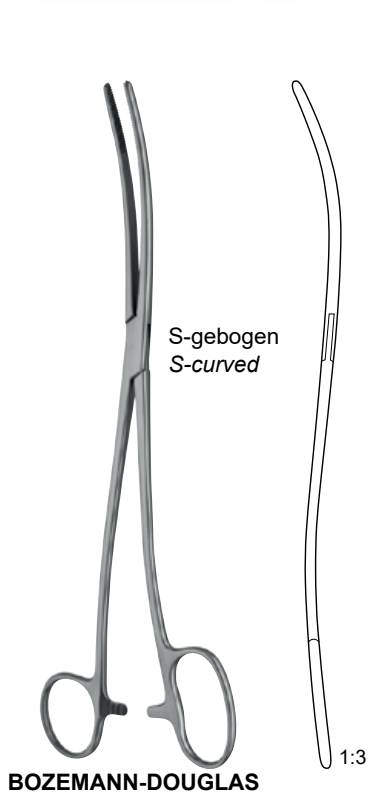
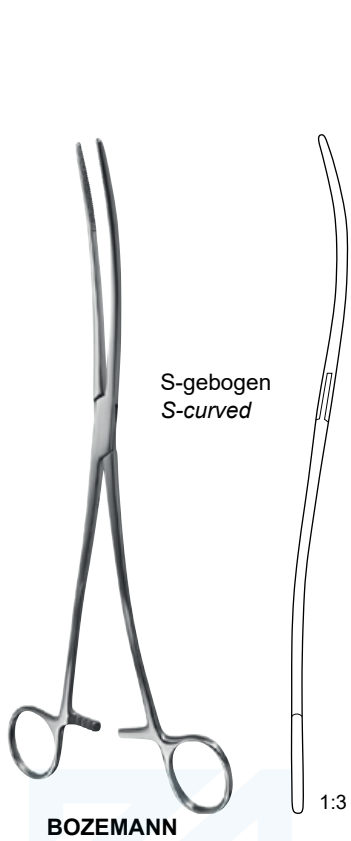



Schwammzangen Sponge Holding Forceps



FÖRSTER-BALLEGER



18 cm – 7"	ZA 3900-18	ZA 3901-18
25 cm – 10"	ZA 3900-25	ZA 3901-25



FÖRSTER-BALLEGER



18 cm – 7"	ZA 3910-18	ZA 3911-18
25 cm – 10"	ZA 3910-25	ZA 3911-25

Schwammzangen Sponge Holding Forceps



RAMPLAY



gerade
straight

18 cm – 7"	25 cm – 10"
ZA 3896-18	ZA 3896-25



ZIMAIZ
INTERNATIONAL



COLLIN

Zungenzange
Tongue holding forceps



16 cm – 6¼"
ZA 8450-16



Bulldogklemmen Bulldog Clamps

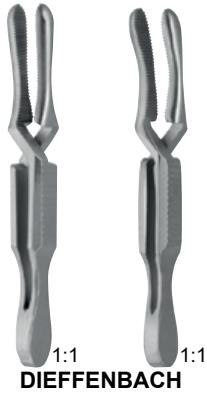

	gerade <i>straight</i>	gebogen <i>curved</i>
3,5 cm – 1½"	ZA 3144-03	ZA 3145-03
5 cm – 2"	ZA 3144-05	ZA 3145-05



	gerade <i>straight</i>	gebogen <i>curved</i>
6 cm – 2½"	ZA 3144-06	ZA 3145-06



	gerade <i>straight</i>	gebogen <i>curved</i>
3,8 cm – 1½"	ZA 3146-11	ZA 3146-01
4,8 cm – 2"	ZA 3146-12	ZA 3146-02
5,7 cm – 2¼"	ZA 3146-13	ZA 3146-03
6,3 cm – 2½"	ZA 3146-14	ZA 3146-04
7 cm – 2¾"	ZA 3146-15	ZA 3146-05
7,5 cm – 3"	ZA 3146-16	ZA 3146-06
9 cm – 3½"	ZA 3146-17	ZA 3146-07

Bulldogklemmen Bulldog Clamps



Mikro-Clips
Micro clips



gerade
straight

2,7 cm – 1¼"

ZA 3930-01



SCHWARTZ

leicht gebogen
slightly curved

2,7 cm – 1¼"

ZA 3930-02



stark gebogen
strongly curved

2,5 cm – 1"

ZA 3930-03



Anlegezange
für SCHWARTZ Mikro-
Clips *Applying forceps for
SCHWARTZ micro clips*

gebogen
curved

19 cm – 7½"

ZA 3930-80

SCHWARTZ



ZIMAIZ
INTERNATIONAL



gewinkelt
angled

4,5 cm – 1¾"

ZA 3936-20

1:1

DE BAKEY-HESS



gewinkelt
angled

5,5 cm – 2¼"

ZA 3936-30

1:1

DE BAKEY-HESS



Bulldogklemmen Bulldog Clamps

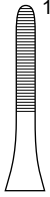
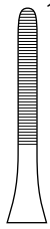

1:1

		
10 mm	14 mm	18 mm
3 cm – 1¼"	3,5 cm – 1½"	4 cm – 1½"
ZA 3932-00	ZA 3932-04	ZA 3932-08



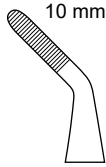
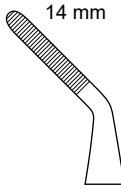
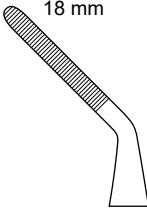

1:1

		
10 mm	14 mm	18 mm
3 cm – 1¼"	3,5 cm – 1½"	4 cm – 1½"
ZA 3932-10	ZA 3932-14	ZA 3932-18



1:1

DIETRICH

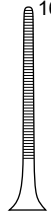
		
8 mm	12 mm	16 mm
4,9 cm – 2"	5,3 cm – 2"	5,6 cm – 2¼"
ZA 3934-08	ZA 3934-12	ZA 3934-16

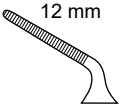
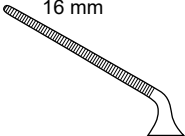
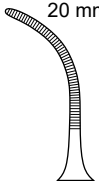
			
8 mm	12 mm	16 mm	20 mm
4,3 cm – 1½"	4,5 cm – 1½"	5,6 cm – 2¼"	5,4 cm – 2"
ZA 3935-08	ZA 3935-12	ZA 3935-16	ZA 3935-21

Bulldogklemmen Bulldog Clamps



DE BAKEY Zahnung
DE BAKEY Serration



1:1
DIETRICH

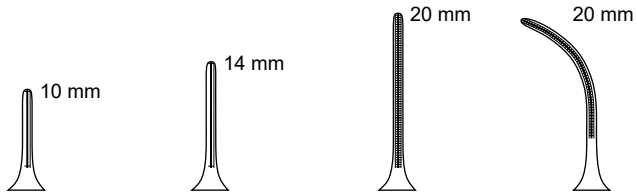

4,7 cm – 2"	5,1 cm – 2"	5,7 cm – 2¼"	5,4 cm – 2"
ZA 3934-60	ZA 3934-64	ZA 3934-70	ZA 3934-71

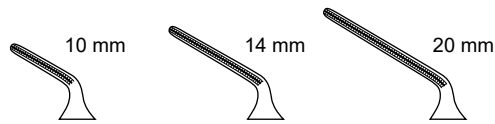

4,4 cm – 1½"	4,6 cm – 1½"	4,9 cm – 2"
ZA 3935-60	ZA 3935-64	ZA 3935-70

ZIMAIZ
INTERNATIONAL



ZIMAIZ
INTERNATIONAL