



ZIMAIZ
INTERNATIONAL



Retractors

SURGICAL
INSTRUMENTS
CATALOGUE





Retraktoren Retractors

Feine Wundhäkchen	<i>Fine Wound Retractors</i>	RE 1 - 2
Wund- und Trachealhäkchen	<i>Wound and Trachea Retractors</i>	RE 3 - 6
Wundhaken	<i>Retractors</i>	RE 7 - 29
Spatel	<i>Spatulas</i>	RE 30
Wundspreizer	<i>Self-retaining Retractors</i>	RE 31 - 47, RE 49
Spezialwundspreizer	<i>Special Retractors</i>	RE 48
Bauchdeckenhalter	<i>Abdominal Retractors</i>	RE 50 - 64



ZIMAIZ
INTERNATIONAL

Feine Wundhäkchen Fine Wound Retractors

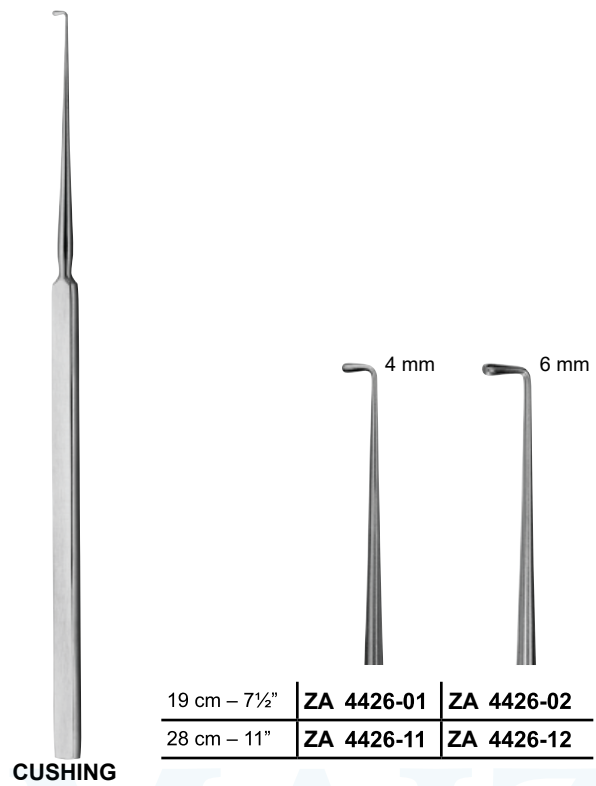
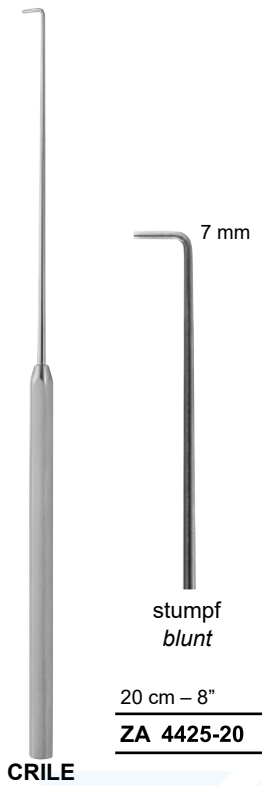

ZIMAIZ
INTERNATIONAL

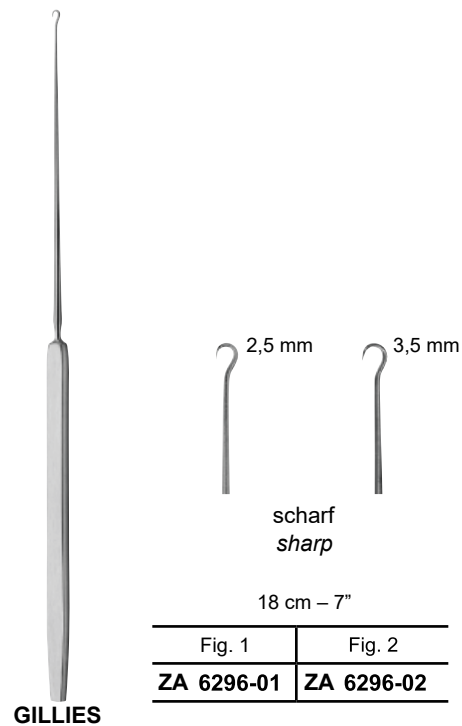
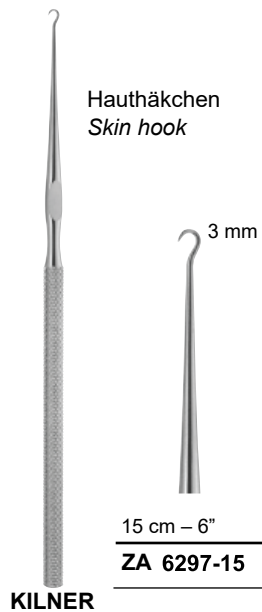



Feine Wundhäkchen Fine Wound Retractors

Hauthäkchen
Skin hook



scharf
sharp

stumpf
blunt

12 cm – 4¾"

ZA 4430-51	ZA 4430-52
------------	------------

GRAEFE



scharf
sharp

12,5 cm – 5"

ZA 4430-53

GUTHRIE



scharf
sharp

13 cm – 5"

ZA 4430-54

GUTHRIE



scharf
sharp

12,5 cm – 5"

ZA 4430-70

O' CONNOR



3 mm

5 mm

7 mm

scharf
sharp

13 cm – 5"

ZA 4435-03	ZA 4435-05	ZA 4435-07
------------	------------	------------

KLEINERT-KUTZ



scharf,
einzahnig
sharp,
single prong

scharf,
zweizahnig
sharp,
double prong

15 cm – 6"

ZA 4436-01	ZA 4436-02
------------	------------

BARSKY

Wund- und Trachealhäkchen Wound and Trachea Retractors

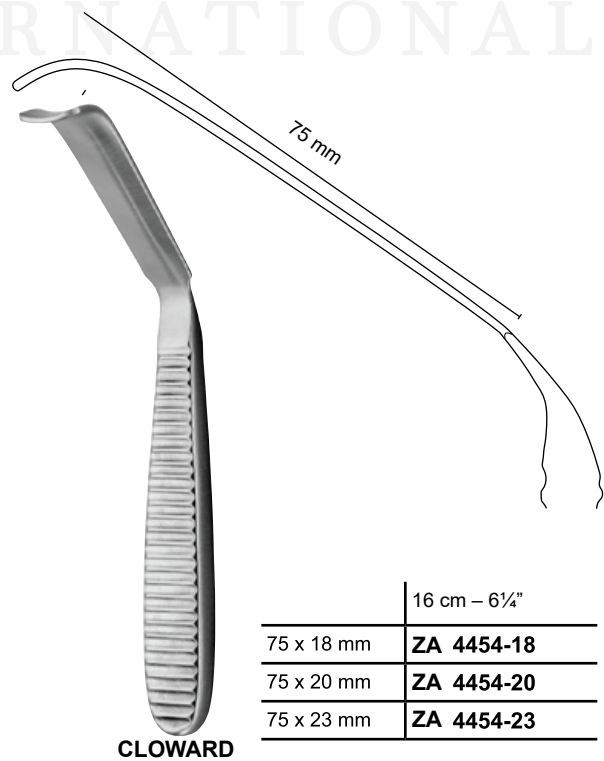
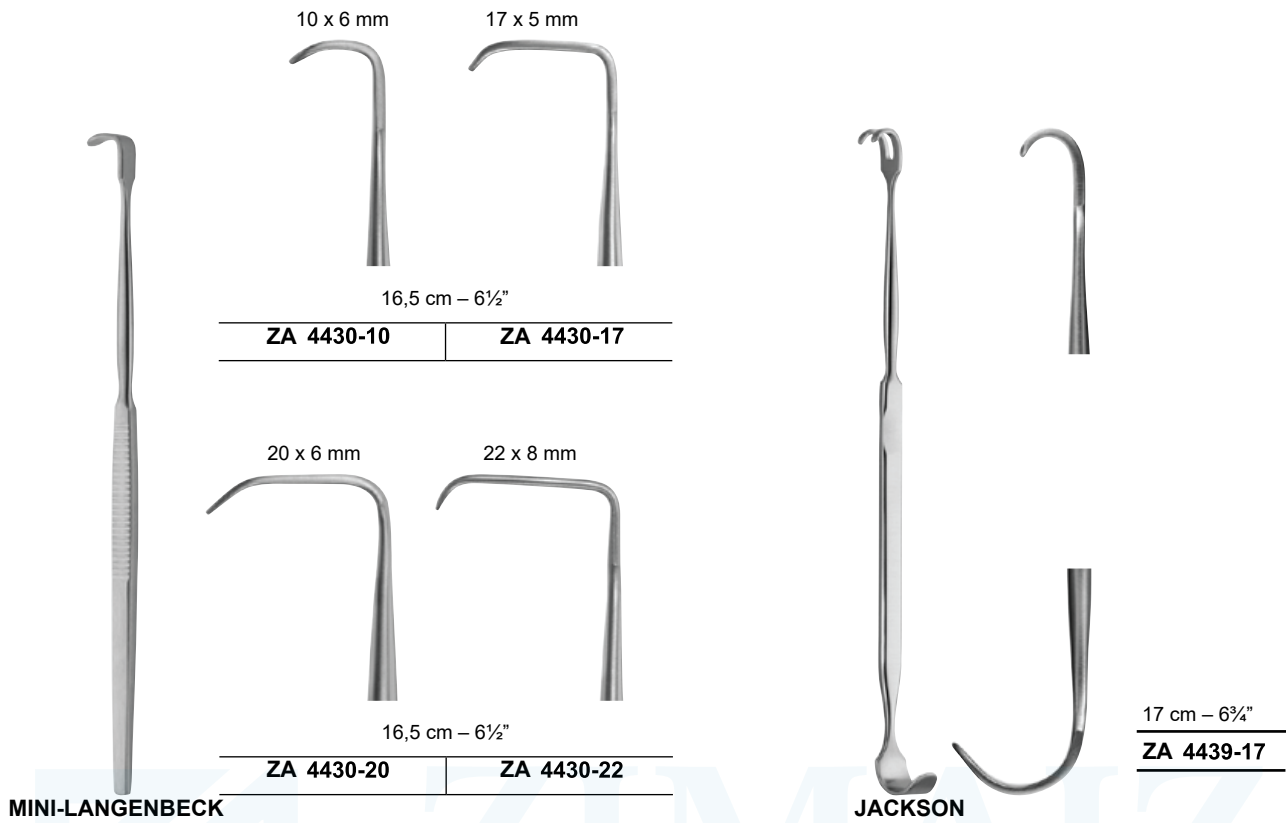



Wund- und Trachealhäkchen Wound and Trachea Retractors



scharf
sharp

16,5 cm – 6½"

ZA 4460-01	ZA 4460-02	ZA 4460-03	ZA 4460-04
------------	------------	------------	------------



stumpf
blunt

16,5 cm – 6½"

ZA 4461-01	ZA 4461-02	ZA 4461-03	ZA 4461-04
------------	------------	------------	------------



scharf
sharp

16 cm – 6¼"

ZA 4462-01	ZA 4462-02	ZA 4462-03	ZA 4462-04
------------	------------	------------	------------



stumpf
blunt

16 cm – 6¼"

ZA 4463-01	ZA 4463-02	ZA 4463-03	ZA 4463-04
------------	------------	------------	------------

Wund- und Trachealhäkchen Wound and Trachea Retractors



scharf
sharp

15,5 cm – 6"

ZA 4464-01	ZA 4464-02	ZA 4464-03	ZA 4464-04
------------	------------	------------	------------

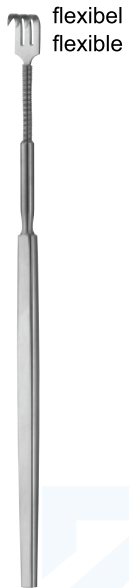

stumpf
blunt

15,5 cm – 6"

ZA 4465-01	ZA 4465-02	ZA 4465-03	ZA 4465-04
------------	------------	------------	------------



scharf
sharp



stumpf
blunt

16 cm – 6¼"

ZA 4466-01	ZA 4466-02
------------	------------



13 cm – 5"

ZA 4468-13



14 cm – 5½"

ZA 4469-14

ZIMAIZ
INTERNATIONAL



Wund- und Trachealhäkchen Wound and Trachea Retractors

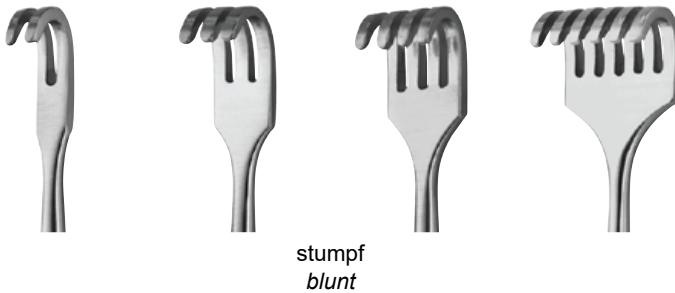
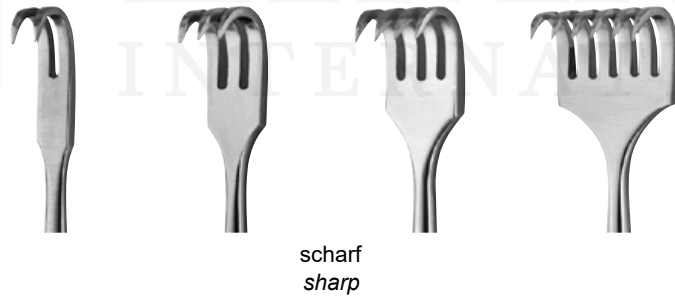
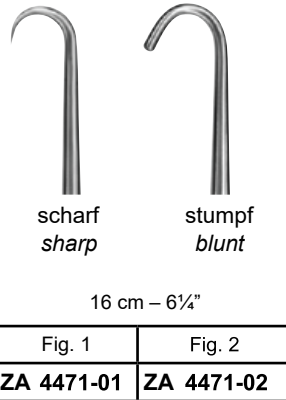



LITTLE

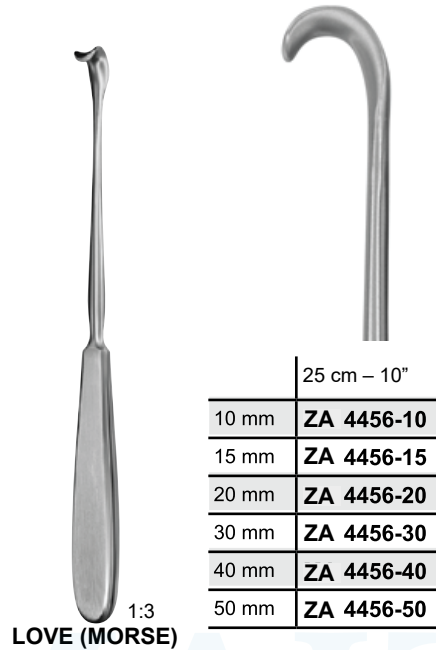

ZIMAIZ
INTERNATIONAL

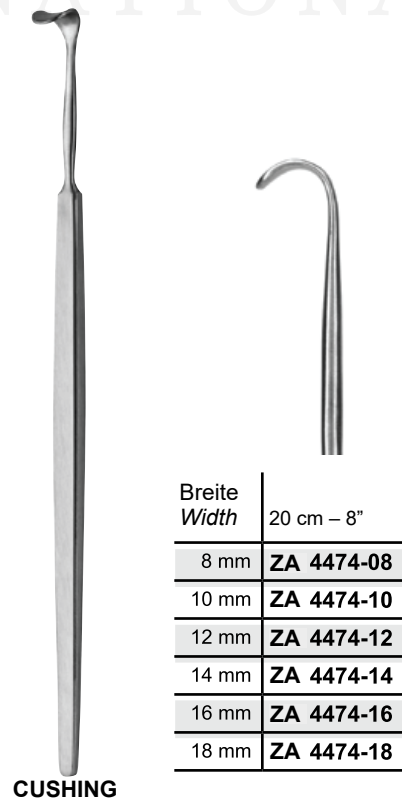
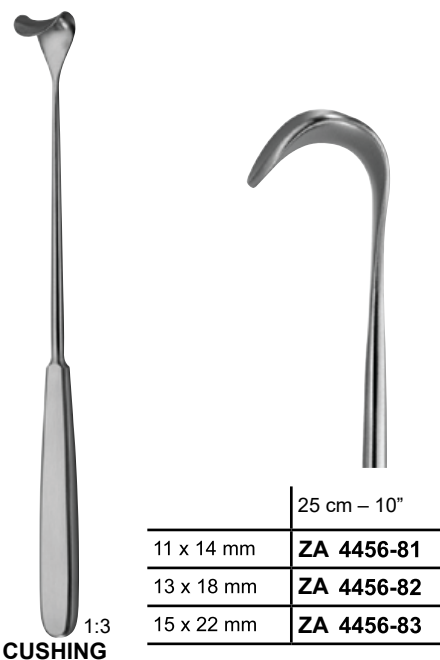



Wundhaken Retractors



CUSHING



Breite Width	24 cm – 9½"
8 mm	ZA 4474-58
10 mm	ZA 4474-60
12 mm	ZA 4474-62
14 mm	ZA 4474-64
16 mm	ZA 4474-66
18 mm	ZA 4474-68

1:3



DESMARRES



Breite Width	14 cm – 5½"
8 mm	ZA 4475-08
10 mm	ZA 4475-10
11 mm	ZA 4475-11
12 mm	ZA 4475-12
13 mm	ZA 4475-13
14 mm	ZA 4475-14
15 mm	ZA 4475-15
16 mm	ZA 4475-16
18 mm	ZA 4475-18



CRILE

12 x 4 mm

20 x 6 mm

11 cm – 4¼"
ZA 4478-11



LUER

11 cm – 4¼"
ZA 4479-11



	17 cm – 6 3/4"
6 x 25 mm	ZA 4481-01
8 x 25 mm	ZA 4481-02

LANGENBECK-GREEN



Dekompressionshaken
Decompression hook

	20 cm – 8"
	ZA 4485-20

CUSHING

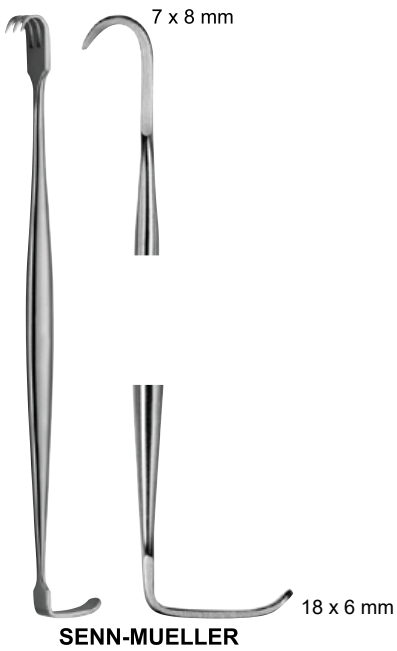

7 x 8 mm

18 x 6 mm

SENN-MUELLER

scharf <i>sharp</i>	stumpf <i>blunt</i>
16 cm – 6 1/4"	
ZA 4486-01	ZA 4486-02



Wundhaken Retractors

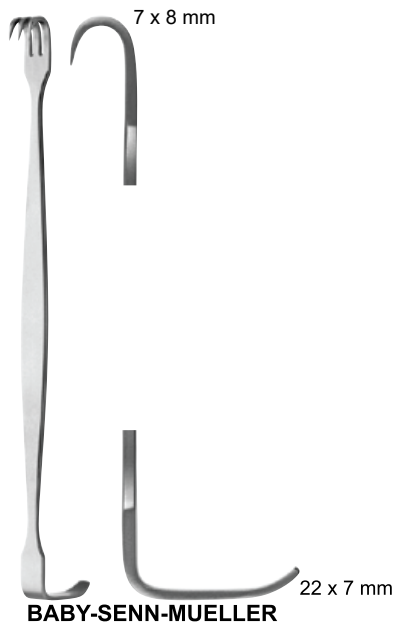

scharf <i>sharp</i>	stumpf <i>blunt</i>
15,5 cm – 6"	
ZA 4487-01	ZA 4487-02

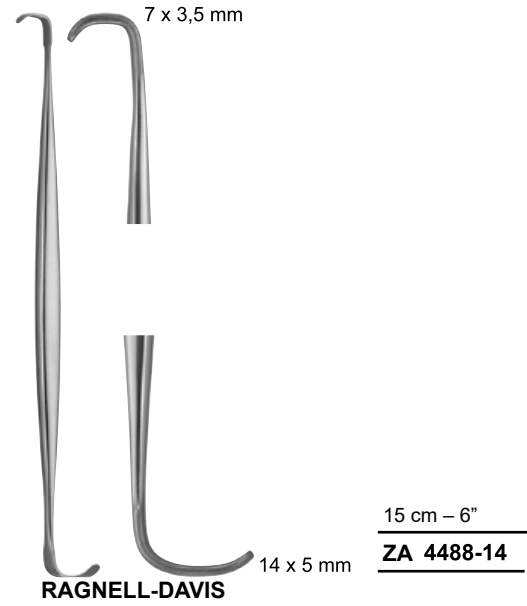

15 cm – 6"
ZA 4488-14

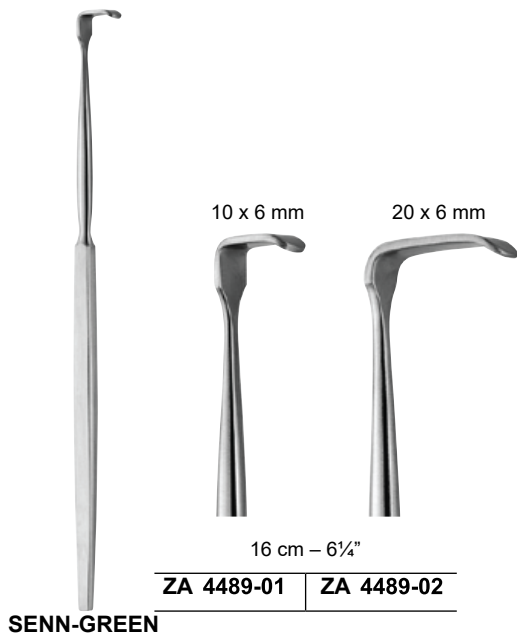

ZA 4489-01	ZA 4489-02
-------------------	-------------------

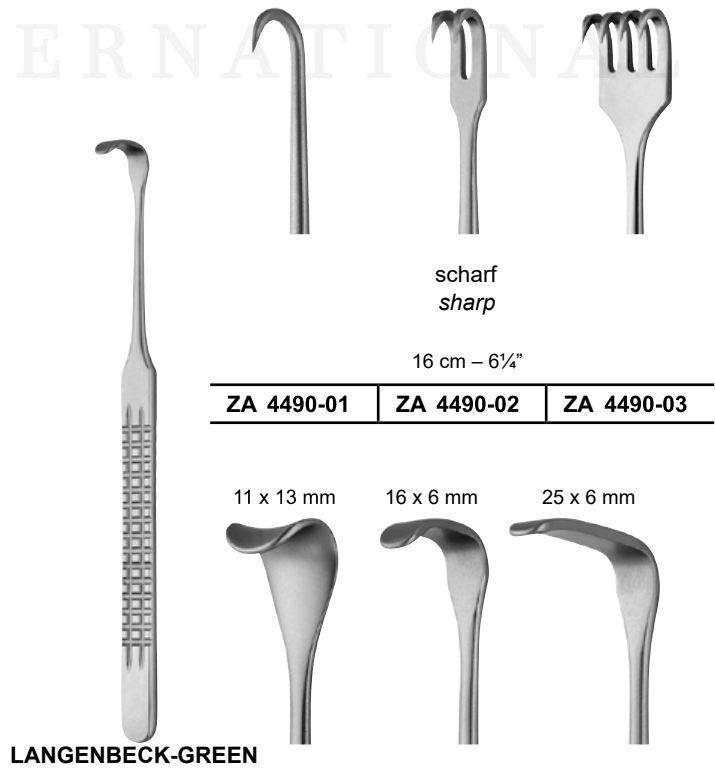

ZA 4490-01	ZA 4490-02	ZA 4490-03
-------------------	-------------------	-------------------

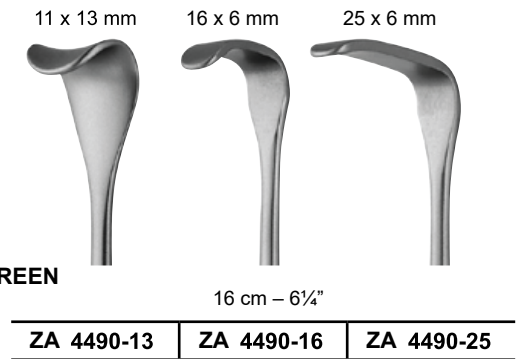

ZA 4490-13	ZA 4490-16	ZA 4490-25
-------------------	-------------------	-------------------



ROUX

MA 4492-00

Satz bestehend aus:

ZA 4492-01, ZA 4492-02, ZA 4492-03

Set consisting of:

ZA 4492-01, ZA 4492-02, ZA 4492-03

14 cm – 5½"	Fig. 1	ZA 4492-01
15 cm – 6"	Fig. 2	ZA 4492-02
17 cm – 6¾"	Fig. 3	ZA 4492-03



BABY-ROUX

17 x 16 mm

18 x 22 mm

13 cm – 5"

ZA 4492-13



30 x 31 mm



GOELET

37 x 40 mm

19 cm – 7½"

ZA 4493-19

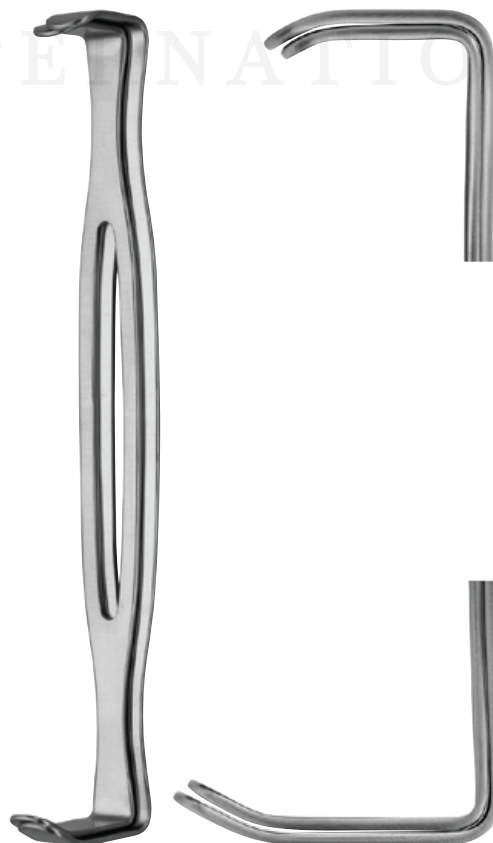

PARKER-LANGENBECK

Satz
Set

21 cm – 8¼"

ZA 4494-21



Wundhaken Retractors



Satz
Set
13,5 cm – 5¼"
ZA 4495-13

PARKER



Satz
Set
18 cm – 7"
ZA 4495-18

PARKER



Satz
Set
16 cm – 6¼"
ZA 4496-00

PARKER-MOTT



ZIMAIZ
INTERNATIONAL



Satz
Set
12 cm – 4¾"
ZA 4497-12

FARABEUF



Satz
Set
15 cm – 6"
ZA 4497-15

FARABEUF



Satz
Set
16,5 cm – 6½"
ZA 4498-00

COLLIN



Satz
Set
19 cm – 7½"
ZA 4499-00

MATHIEU

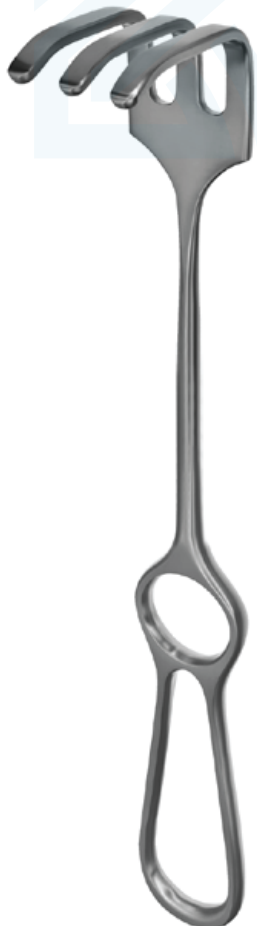

OLLIER

ZIMAIZ
INTERNATIONAL



22,5 cm – 8¾"

ZA 4510-03

ZA 4510-04



Wundhaken Retractors

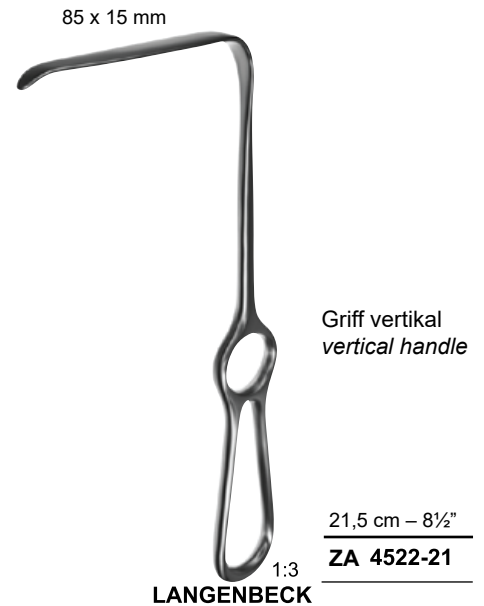
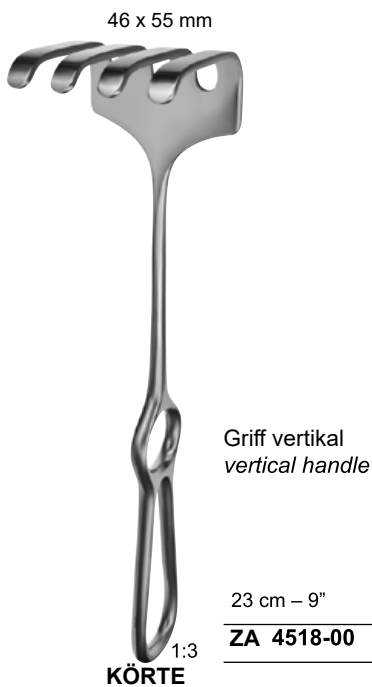
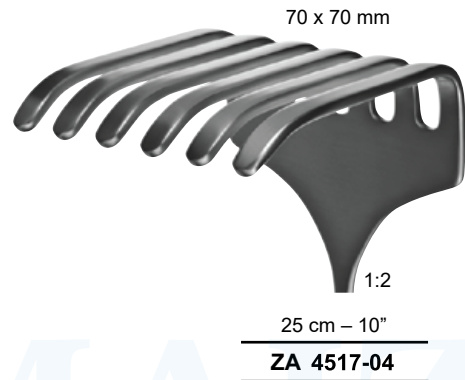
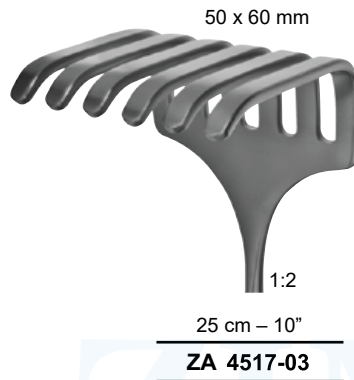
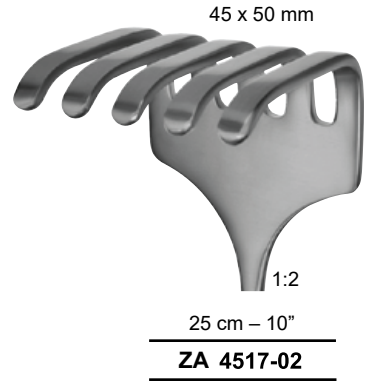
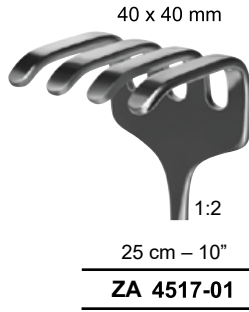

Wundhaken Retractors



LANGENBECK

	21 cm – 8¼"
55 x 20 mm	ZA 4522-01
63 x 20 mm	ZA 4522-02
60 x 20 mm	ZA 4522-05



LANGENBECK



	23 cm – 9"
35 x 7 mm	ZA 4523-01
35 x 10 mm	ZA 4523-02
35 x 15 mm	ZA 4523-03
60 x 20 mm	ZA 4523-04

28 x 6 mm



LAHEY

	19 cm – 7½"
	ZA 4525-19



SAUERBRUCH



	22,5 cm – 8¾"
45 x 15 mm	ZA 4526-01
55 x 23 mm	ZA 4526-02
72 x 20 mm	ZA 4526-03





Wundhaken Retractors



LANGENBECK

38 x 20 mm



21 cm – 8¼"

30 x 11 mm	ZA 4530-01
30 x 14 mm	ZA 4530-02
33 x 14 mm	ZA 4530-03
30 x 16 mm	ZA 4530-04
40 x 11 mm	ZA 4530-05
42 x 13 mm	ZA 4530-06
50 x 11 mm	ZA 4530-07



LANGENBECK

Hohlheftgriff
Hollow handle

22 cm – 8¾"

30 x 11 mm	ZA 4531-01
40 x 11 mm	ZA 4531-05
42 x 13 mm	ZA 4531-06



KOCHER

22 cm – 8¾"

ZA 4535-01



KOCHER

19 cm – 7½"

19 x 12 mm	ZA 4536-01
21 x 12 mm	ZA 4536-02



Wundhaken Retractors



KOCHER-LANGENBECK

	21,5 cm – 8½"
25 x 6 mm	ZA 4538-11
25 x 8 mm	ZA 4538-12
35 x 8 mm	ZA 4538-13
35 x 11 mm	ZA 4538-14
35 x 15 mm	ZA 4538-15
40 x 11 mm	ZA 4538-16
55 x 11 mm	ZA 4538-17
70 x 14 mm	ZA 4538-18
80 x 12 mm	ZA 4538-19
80 x 16 mm	ZA 4538-20



CASPAR

21,5 cm – 8½"
ZA 4537-21



KOCHER

	23 cm – 9"
40 x 18 mm	ZA 4539-11
60 x 20 mm	ZA 4539-12
60 x 25 mm	ZA 4539-13
75 x 30 mm	ZA 4539-14
75 x 40 mm	ZA 4539-15



KOCHER-WAGNER

	28 cm – 11"
22 x 15 mm	ZA 4540-01
38 x 20 mm	ZA 4540-02
67 x 25 mm	ZA 4540-03
100 x 35 mm	ZA 4540-04



Wundhaken Retractors



ST. MARKS

	29 cm – 11 ½"
160 x 60 mm	ZA 4543-00/29



ST. MARKS

	32,5 cm – 12 ¾"
180 x 60 mm	ZA 4543-00/32



ZIMAIZ
INTERNATIONAL



ST. MARKS

	33 cm – 13"
180 x 60 mm	ZA 4543-00/33



	25 cm – 10"
60 x 20 mm	ZA 4542-01
80 x 30 mm	ZA 4542-02
100 x 30 mm	ZA 4542-03
120 x 30 mm	ZA 4542-04
140 x 30 mm	ZA 4542-05
140 x 40 mm	ZA 4542-06



	21 cm – 8¼"
70 x 40 mm	ZA 4544-40
70 x 50 mm	ZA 4544-50
70 x 65 mm	ZA 4544-65



19 cm – 7½"	16 mm	ZA 4544-47
19 cm – 7½"	20 mm	ZA 4544-48
20 cm – 8"	25 mm	ZA 4544-49



	24 cm – 9½"
32 x 50 mm / 38 x 50 mm	ZA 4544-01
45 x 50 mm / 50 x 50 mm	ZA 4544-02
65 x 50 mm / 38 x 50 mm	ZA 4544-03

ZIMAIZ
INTERNATIONAL



Wundhaken Retractors



1:3
WYLIE

30,5 cm – 12"	75 x 23 mm	ZA 4548-30
33 cm – 13"	175 x 23 mm	ZA 4548-33



GREEN

22 cm – 8¾"	ZA 4549-22
-------------	-------------------



MIDDELDORPF

21,5 cm – 8½"	14 x 17 mm	ZA 4551-01
22 cm – 8¾"	20 x 22 mm	ZA 4551-02
23,5 cm – 9¼"	26 x 30 mm	ZA 4551-03



1:3
MIDDELDORPF

25,5 cm – 10"	
45 x 45 mm	ZA 4551-51
45 x 50 mm	ZA 4551-52
55 x 70 mm	ZA 4551-53

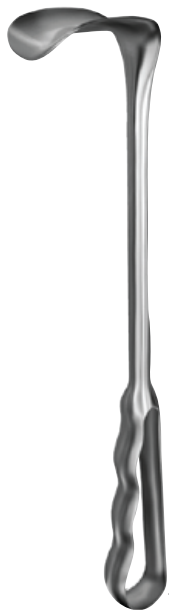

1:3

RICHARDSON

	24 cm – 9½"
28 x 20 mm	ZA 4552-11
30 x 28 mm	ZA 4552-12
38 x 37 mm	ZA 4552-13
52 x 22 mm	ZA 4552-14



1:3

RICHARDSON-EASTMAN

MA 4553-00

Satz bestehend aus:
MA 4553-01, MA 4553-02

Set consisting of:
MA 4553-01, MA 4553-02

25 cm – 10"	24 x 22 mm / 30 x 30 mm	Fig. 1	ZA 4553-01
27 cm – 10½"	40 x 37 mm / 65 x 43 mm	Fig. 2	ZA 4553-02



ZIMAIZ
INTERNATIONAL

51 x 19 mm



1:3

RICHARDSON

	23,5 cm – 9¼"
	ZA 4552-55



1:3

RICHARDSON

	24 cm – 9½"
64 x 41 mm	ZA 4552-51
25 x 19 mm	ZA 4552-52
32 x 25 mm	ZA 4552-53
38 x 38 mm	ZA 4552-54



Wundhaken Retractors



KELLY

	26 cm – 10¼"
40 x 50 mm	ZA 4554-00
50 x 65 mm	ZA 4554-01
65 x 75 mm	ZA 4554-02
75 x 90 mm	ZA 4554-03



KELLY

	25 cm – 10"
51 x 38 mm	ZA 4554-50
64 x 51 mm	ZA 4554-51
76 x 64 mm	ZA 4554-52
89 x 76 mm	ZA 4554-53



FRITSCH

ZA

	24 cm – 9½"
45 x 40 mm	ZA 4555-01
45 x 50 mm	ZA 4555-02
45 x 60 mm	ZA 4555-03
45 x 75 mm	ZA 4555-04
65 x 85 mm	ZA 4555-05



DOYEN

50 x 85 mm	25 cm – 10"
	ZA 4556-25



1:3
DOYEN-STILLE

	24 cm – 9½"
15 x 90 mm	ZA 4557-01
20 x 90 mm	ZA 4557-02
30 x 90 mm	ZA 4557-03
35 x 110 mm	ZA 4557-04
40 x 110 mm	ZA 4557-05
55 x 120 mm	ZA 4557-06



1:3
KOCHER

	22,5 cm – 8¾"
	ZA 4557-22



ZIMAIZ
INTERNATIONAL



1:3
KOCHER

	25 cm – 10"
80 x 42 mm	ZA 4558-01
80 x 50 mm	ZA 4558-02
80 x 60 mm	ZA 4558-03



1:3
SIMON

	28 cm – 11"
115 x 22 mm	ZA 4560-01
115 x 27 mm	ZA 4560-02



Wundhaken Retractors

105 x 27 mm



1:3
MARTIN

26 cm – 10¼"

ZA 4562-26



1:3
BRUNNER

	25 cm – 10"
80 x 20 mm	ZA 4563-08
100 x 25 mm	ZA 4563-10
120 x 25 mm	ZA 4563-12
130 x 30 mm	ZA 4563-13
140 x 30 mm	ZA 4563-14
160 x 30 mm	ZA 4563-16
180 x 30 mm	ZA 4563-18



ZIMAIZ

INTERNATIONAL

19 mm



DEAVER

18 cm – 7"

ZA 4570-01

22 mm



DEAVER

21,5 cm – 8½"

ZA 4570-02



25 mm

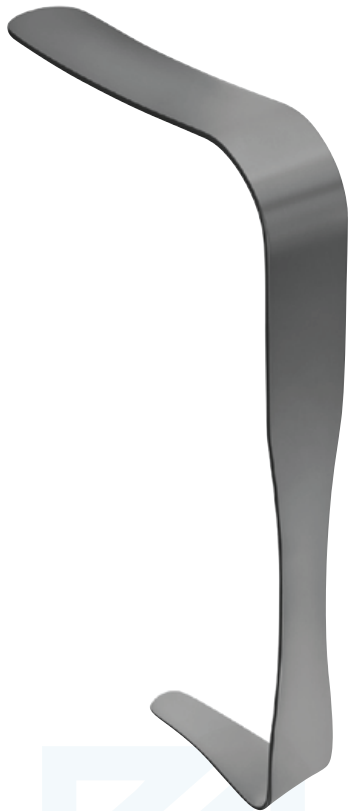

DEAVER

23 cm – 9"

ZA 4570-03

25 mm



1:3
DEAVER

30 cm – 11¼" | **ZA 4570-04**

33 cm – 13" | **ZA 4570-05**

36 cm – 14¼" | **ZA 4570-06**



1:3
DEAVER

30 cm – 11¼"

38 mm | **ZA 4570-07**

50 mm | **ZA 4570-08**

75 mm | **ZA 4570-09**



1:3
DEAVER

Hohlgriff
Hollow handle

30 cm – 11¼"

25 mm | **ZA 4571-04**

38 mm | **ZA 4571-07**

50 mm | **ZA 4571-08**

75 mm | **ZA 4571-09**



Wundhaken Retractors



1:3
HARRINGTON

	32 cm – 12½"
40 x 127 mm	ZA 4572-01
62 x 127 mm	ZA 4572-02



MEYERDING

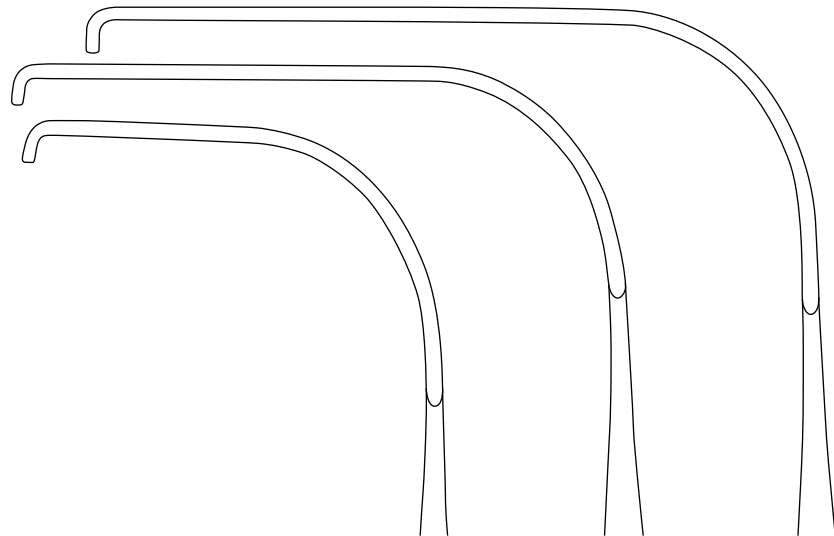

52 x 16 mm	76 x 25 mm	89 x 50 mm
23 cm – 9"	23 cm – 9"	25,5 cm – 10"
ZA 4573-01	ZA 4573-02	ZA 4573-03



HIBBS

ZA 4575-00

Satz bestehend aus:
ZA 4575-01, ZA 4575-02

Set consisting of:
ZA 4575-01, ZA 4575-02

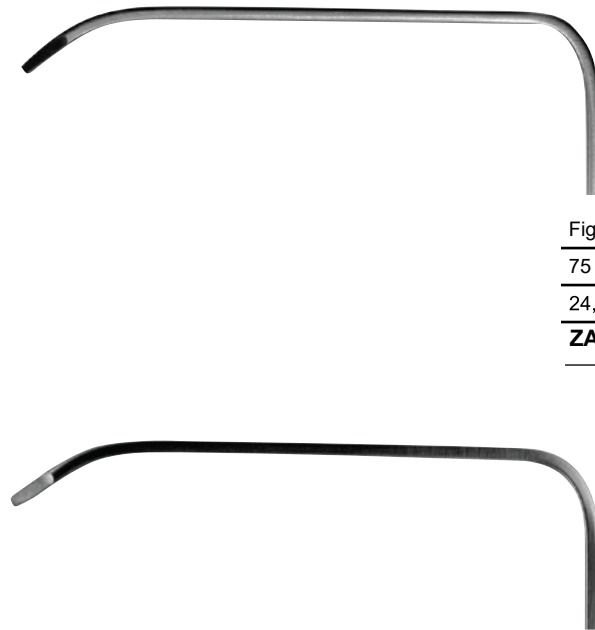

Fig. 1

75 x 25 mm

24,5 cm – 9¾"

ZA 4575-01

Fig. 2

80 x 25 mm

24,5 cm – 9¾"

ZA 4575-02

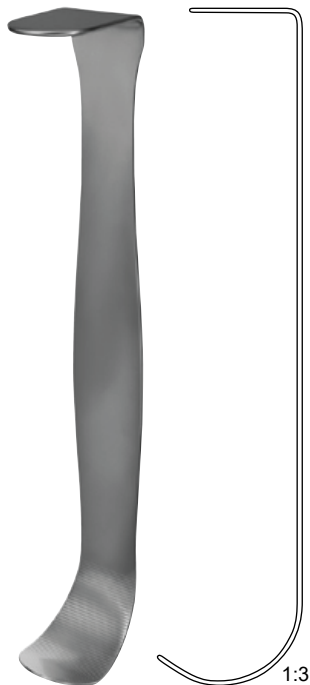

HEANEY

1:3

	27 cm – 10½"
45 x 25 mm	ZA 4575-51
73 x 28 mm	ZA 4575-52
82 x 28 mm	ZA 4575-53



LERICHE

1:3

45 mm

25,5 cm – 10"

ZA 4579-01

60 mm

27,5 cm – 10¾"

ZA 4579-02



Retractors



BRUNNER

	25,5 cm – 10"
80 x 20 mm	ZA 4564-01
100 x 20 mm	ZA 4564-02
120 x 25 mm	ZA 4564-03
140 x 25 mm	ZA 4564-04



1:3

	26 cm – 10¼"
85 x 35 mm	ZA 4565-01
120 x 50 mm	ZA 4565-02
155 x 50 mm	ZA 4565-03



MIKULICZ

90 x 50 mm

	26 cm – 10¼"
	ZA 4566-26

1:3



KELLY

1:3

	27 cm – 10½"
160 x 38 mm	ZA 4567-01
160 x 57 mm	ZA 4567-02
190 x 38 mm	ZA 4567-51
190 x 57 mm	ZA 4567-52

Wundhaken Retractors



	16 cm – 6¼"
75 x 50 mm	ZA 4590-01
75 x 90 mm	ZA 4590-02



DAVIDSON

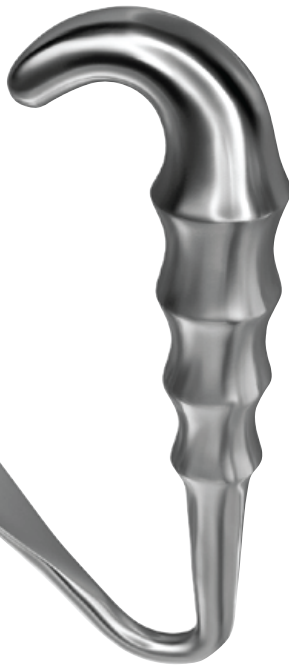

ROSS

		27 cm – 10½"
Fig. 1	15 x 16 mm	ZA 4593-01
Fig. 2	13 x 23 mm	ZA 4593-02
Fig. 3	17 x 23 mm	ZA 4593-03
Fig. 4	13 x 27 mm	ZA 4593-04
Fig. 5	29 x 29 mm	ZA 4593-05
Fig. 6	40 x 21 mm	ZA 4593-06



COOLEY



35 x 45 mm
21,5 cm – 8½"

ZA 4591-01

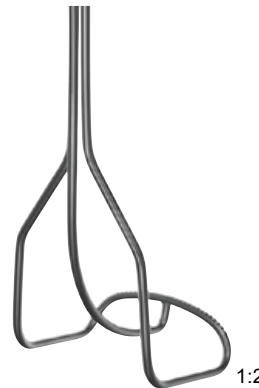

45 x 50 mm
21,5 cm – 8½"

ZA 4591-02



20 x 50 mm
26 cm – 10¼"

ZA 4591-03



Spatel Spatulas



biegsam
malleable

	33 cm – 13"
20 mm	ZA 4580-20
25 mm	ZA 4580-25
30 mm	ZA 4580-30
35 mm	ZA 4580-35
40 mm	ZA 4580-40
45 mm	ZA 4580-45
50 mm	ZA 4580-50
64 mm	ZA 4580-64
76 mm	ZA 4580-76
102 mm	ZA 4580-99

1:3



biegsam
malleable

17 / 25 mm
20 cm – 8"
ZA 4582-20

TUFFIER



biegsam
malleable

20 cm – 8"	6 mm	ZA 4584-06
	8 mm	ZA 4584-08
	10 mm	ZA 4584-10
	12 mm	ZA 4584-12
	17 mm	ZA 4584-17
	20 mm	ZA 4584-20
25 cm – 10"	25 mm	ZA 4584-25
	25 mm	ZA 4584-29

ZIMAIZ
INTERNATIONAL



biegsam
malleable

28 cm – 11"	25 / 30 mm	ZA 4585-01
30 cm – 11¼"	37 / 45 mm	ZA 4585-02
	40 / 50 mm	ZA 4585-03

HABERER

1:3



28,5 cm – 11¼"
ZA 4587-28

REVERDIN

1:3

Wundspreizer Self-retaining Retractors

2 : 3 Zähne
2 : 3 teeth

	scharfsharp	stumpfblunt
5 cm – 2"	ZA 4640-05	ZA 4641-05

FINSEN



3 : 4 Zähne
3 : 4 teeth

	scharfsharp	stumpfblunt
7 cm – 2¾"	ZA 4640-07	ZA 4641-07

FINSEN

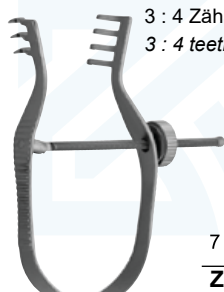

3 : 4 Zähne
3 : 4 teeth



scharfsharp

7 cm – 2¾"
ZA 4642-07

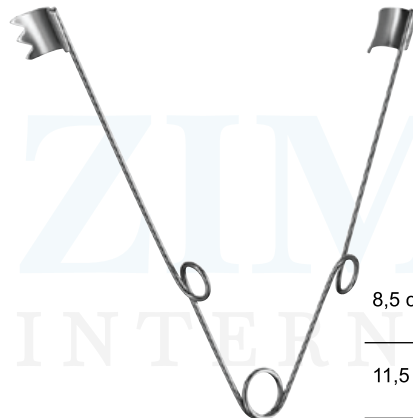
FINSEN



8,5 cm – 3¼"	Spreizweite: 60 mm Spread: 60 mm	ZA 4643-08
11,5 cm – 4½"	Spreizweite: 60 mm Spread: 60 mm	ZA 4643-11



scharfsharp

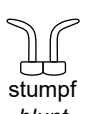

stumpfblunt

7 cm – 2¾"	ZA 4650-07	ZA 4651-07
10 cm – 4"	–	ZA 4651-10

ALM

scharfsharp



stumpfblunt

10 cm – 4"

ZA 4655-00	ZA 4655-10
-------------------	-------------------

HEISS



Wundspreizer Self-retaining Retractors

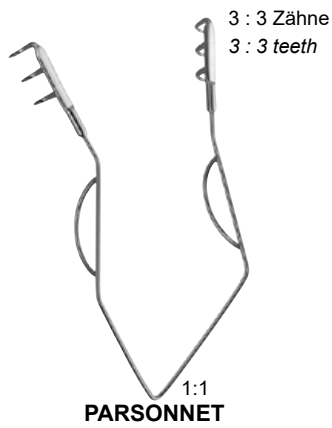

Größe Size	Epicardial Wundspreizer Epicardial retractors	
25 mm	Spreizweite: 15 mm Spread: 15 mm	ZA 4660-01
33 mm	Spreizweite: 19 mm Spread: 19 mm	ZA 4660-02
38 mm	Spreizweite: 24 mm Spread: 24 mm	ZA 4660-03
52 mm	Spreizweite: 32 mm Spread: 32 mm	ZA 4660-04

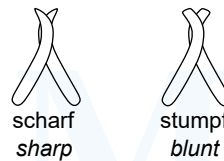

10 cm – 4"

Spreizweite: 45 mm Spread: 45 mm	ZA 4680-10	ZA 4681-10
-------------------------------------	-------------------	-------------------

Wundspreizer Self-retaining Retractors

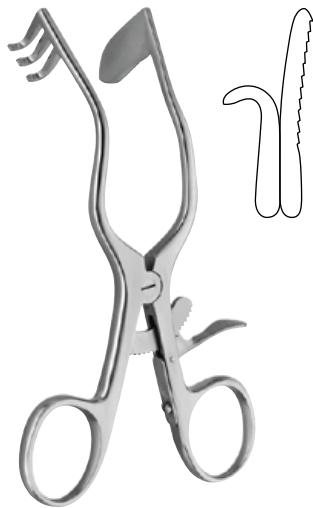

PERKINS

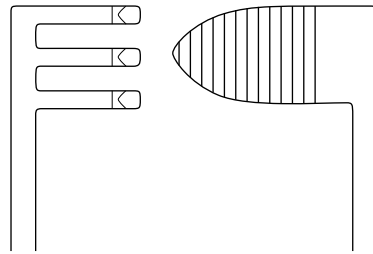

volles Blatt rechts,
scharf gezahnt
*solid blade right,
sharp serrated*

13 cm – 5"

ZA 4688-01

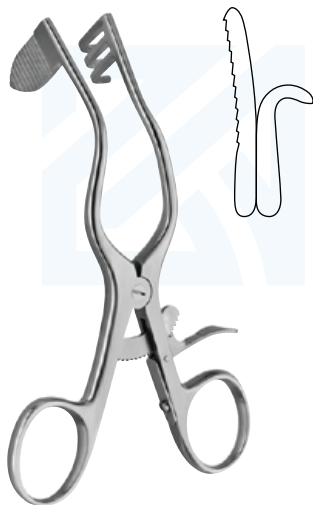

PERKINS

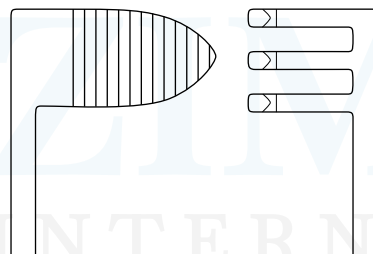

volles Blatt links,
scharf gezahnt
*solid blade left,
sharp serrated*

13 cm – 5"

ZA 4688-02



Wundspreizer Self-retaining Retractors

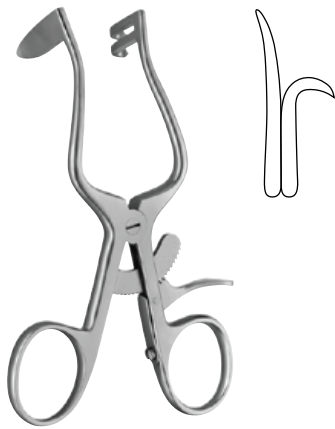

PLESTER

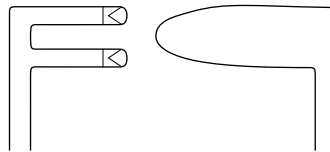

Blatt links voll
Blatt rechts 2 Zähne, scharf
Blade left solid, sharp
Blade left 2 teeth, sharp

11 cm – 4 1/4"

ZA 4690-01

Spreizweite: 55 mm
Spread: 55 mm



PLESTER

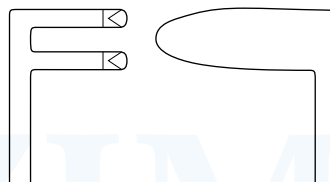

Blatt rechts voll
Blatt links 2 Zähne, scharf

Blade right solid, sharp
Blade left 2 teeth, sharp

11 cm – 4 1/4"

ZA 4690-02

Spreizweite: 55 mm
Spread: 55 mm



PLESTER

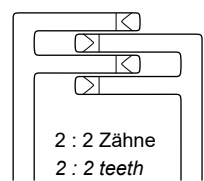

scharf stumpf
sharp *blunt*

13 cm – 5"

ZA 4691-01

ZA 4691-02

Spreizweite: 60 mm
Spread: 60 mm

Wundspreizer Self-retaining Retractors

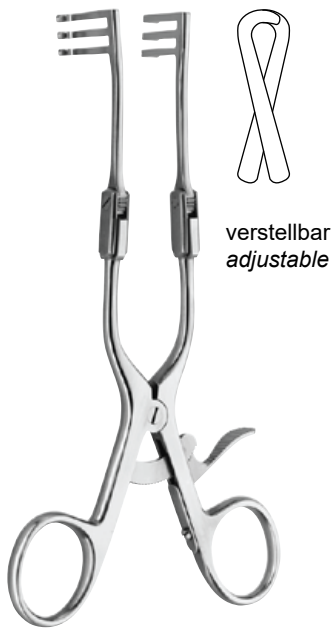

FISH

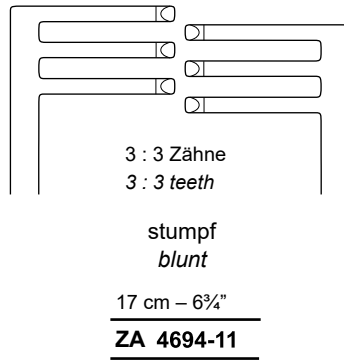

WEITLANER

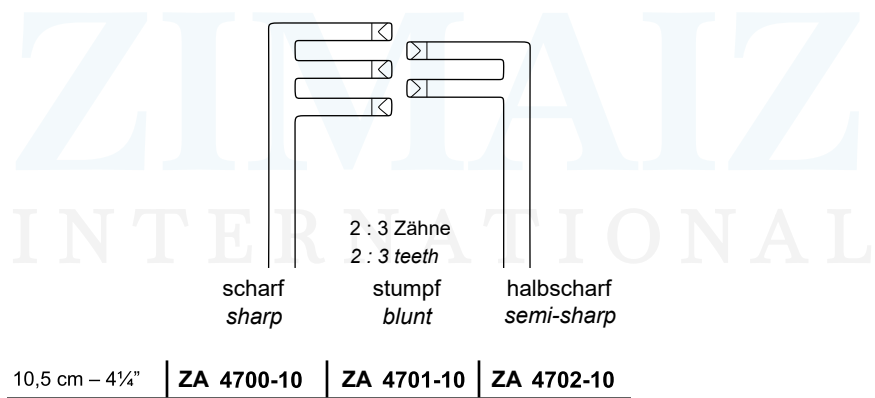

WEITLANER

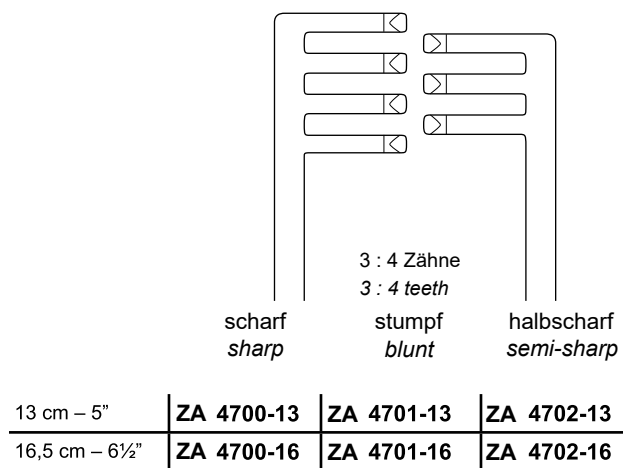



Wundspreizer Self-retaining Retractors

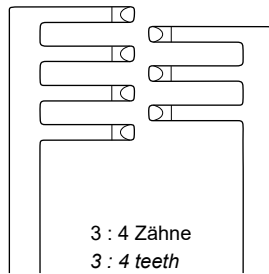

3 : 4 Zähne
3 : 4 teeth

stumpf
blunt

14 cm – 5½"

ZA 4709-10

JEFFERSEN

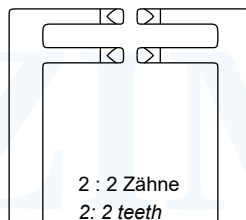
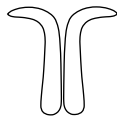

2 : 2 Zähne
2 : 2 teeth

scharf
sharp

14 cm – 5½"

ZA 4709-20

MOLLISON

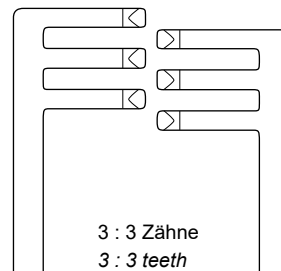

3 : 3 Zähne
3 : 3 teeth

scharf
sharp

stumpf
blunt

13 cm – 5"

Spreizweite: 45 mm
Spread: 45 mm

ZA 4710-13

ZA 4711-13

16,5 cm – 6½"

Spreizweite: 75 mm
Spread: 75 mm

ZA 4710-16

ZA 4711-16

WEITLANER-WULLSTEIN

Wundspreizer Self-retaining Retractors



MOLLISON

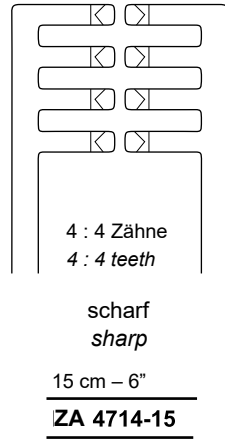

CLOWARD

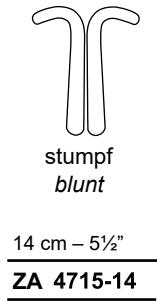

ZIMAIZ
INTERNATIONAL



**TÜBINGER MODELL
TUEBINGEN PATTERN**

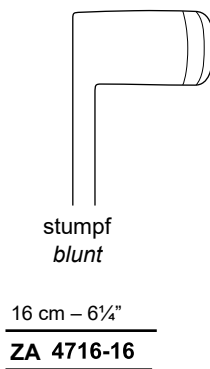



Wundspreizer Self-retaining Retractors



MAYO-ADAMS

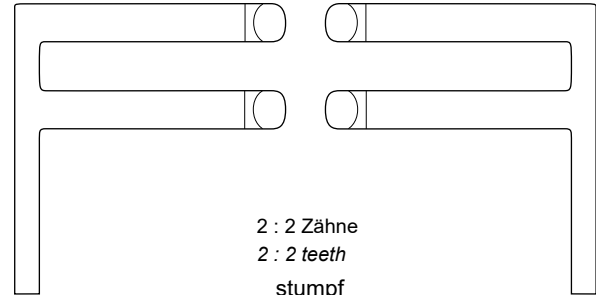
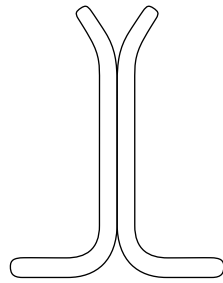

2 : 2 Zähne
2 : 2 teeth
stumpf
blunt

17 cm – 6¾"

ZA 4755-17



ZIMAIZ
INTERNATIONAL



MAYO-ADAMS

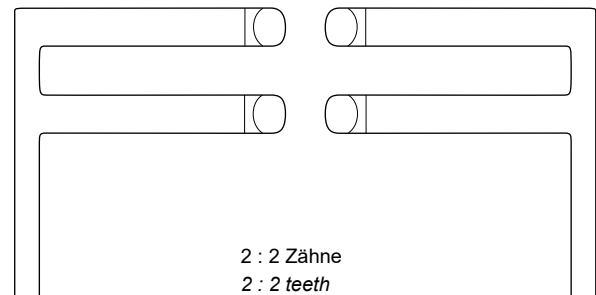
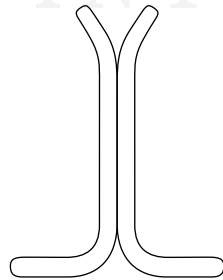

2 : 2 Zähne
2 : 2 teeth
stumpf
blunt

17 cm – 6¾"

ZA 4756-17

Wundspreizer Self-retaining Retractors

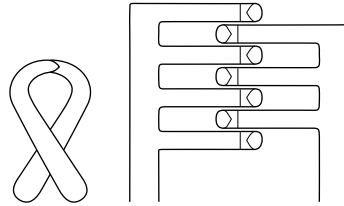

scharf
sharp

Wundsperrer komplett, bestehend aus:
Retractor complete, consisting of: **ZA 4718-00**

Sperrer
Retractor

3 Mittelvalven (ZA 4718-19, -25, -32)
3 *Central blades* (ZA 4718-19, -25, -32)



HENLEY

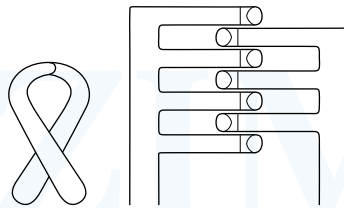

stumpf
blunt

Wundsperrer komplett, bestehend aus:
Retractor complete, consisting of: **ZA 4718-01**

Sperrer
Retractor

3 Mittelvalven (ZA 4718-19, -25, -32)
3 *Central blades* (ZA 4718-19, -25, -32)



Mittelvalven
Central blades

19 x 16 mm	25 x 16 mm	32 x 16 mm
ZA 4718-19	ZA 4718-25	ZA 4718-32



Wundspreizer Self-retaining Retractors



HENLEY

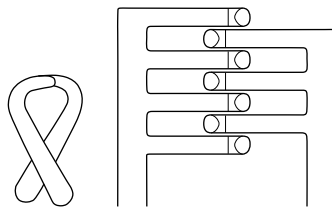

Standard

Sperrer, allein 17 cm – 6¾" <i>Retractor, only 17 cm – 6¾"</i>	ZA 4719-17
Wundsperrer komplett, bestehend aus: <i>Retractor complete, consisting of:</i>	ZA 4719-20
Sperrer allein (ZA 4719-17) <i>Retractor only (ZA 4719-17)</i>	
3 Mittelvalven (ZA 4719-21, -22, -23) <i>3 Central blades (ZA 4719-21, -22, -23)</i>	

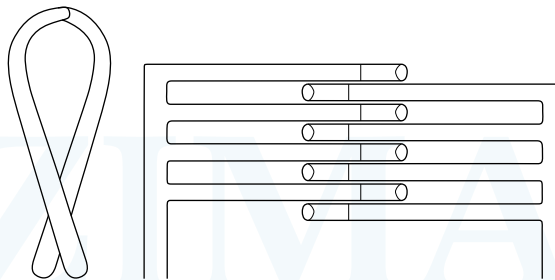

Tiefes Modell
Deep Type

Sperrer, allein 17 cm – 6¾" <i>Retractor, only 17 cm – 6¾"</i>	ZA 4719-27
Wundsperrer komplett, bestehend aus: <i>Retractor complete, consisting of:</i>	ZA 4719-30
Sperrer allein (ZA 4719-27) <i>Retractor only (ZA 4719-27)</i>	
3 Mittelvalven (ZA 4719-21, -22, -23) <i>3 Central blades (ZA 4719-21, -22, -23)</i>	



Mittelvalven
Central blades

Fig. 1	Fig. 2	Fig. 3
20 x 16 mm	25 x 16 mm	30 x 16 mm
ZA 4719-21	ZA 4719-22	ZA 4719-23

Wundspreizer Self-retaining Retractors

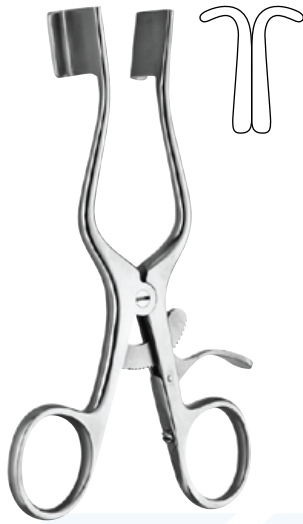

WEITLANER-BABY

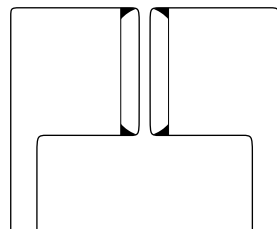

stumpf
blunt

13 cm – 5"

ZA 4719-13



MILLIGAN

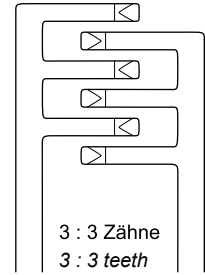

scharf
sharp stumpf
blunt

13 cm – 5"

ZA 4720-13

ZA 4721-13



CONE (ADSON-BABY)

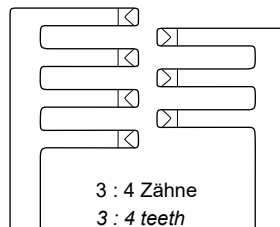

scharf
sharp stumpf
blunt

14 cm – 5½"

ZA 4722-13

ZA 4723-13

16 cm – 6¼"

ZA 4722-16

ZA 4723-16

ZIMAIZ
INTERNATIONAL



Wundspreizer Self-retaining Retractors



WEITLANER

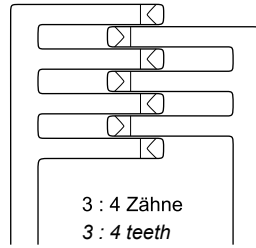

scharf stumpf
sharp *blunt*

20 cm – 8"

ZA 4724-20 | **ZA 4725-20**

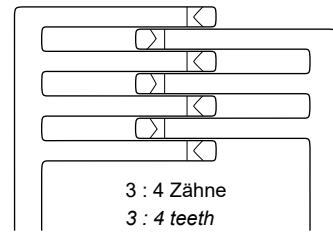

scharf stumpf
sharp *blunt*

24 cm – 9½"

ZA 4724-25 | **ZA 4725-25**

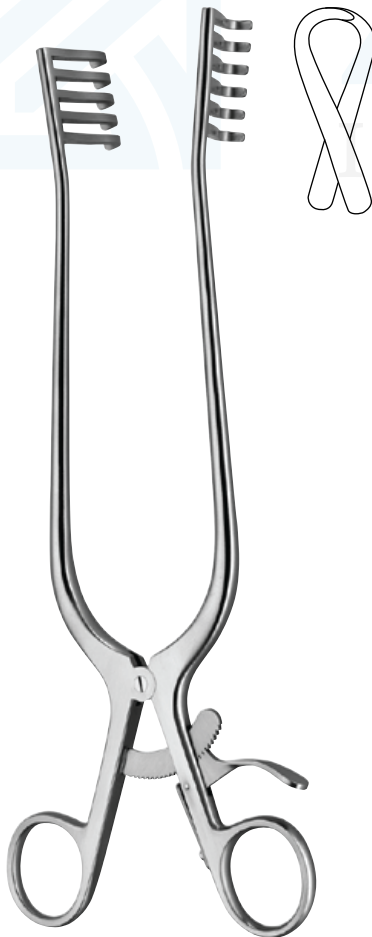

WEITLANER

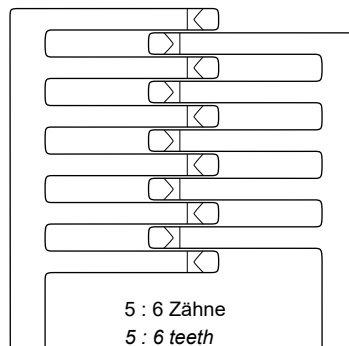

scharf stumpf
sharp *blunt*

25 cm – 10"

ZA 4726-25 | **ZA 4727-25**



ADSON

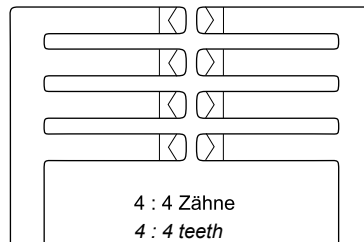

scharf stumpf
sharp blunt

19,5 cm – 7³/₄"

ZA 4728-20 | **ZA 4729-20**

ZIMAIZ
INTERNATIONAL



ANDERSON-ADSON

4 : 4 Zähne
4 : 4 teeth

scharf stumpf
sharp blunt

20 cm – 8"

ZA 4730-20 | **ZA 4731-20**



Wundspreizer Self-retaining Retractors



ADSON

1:3

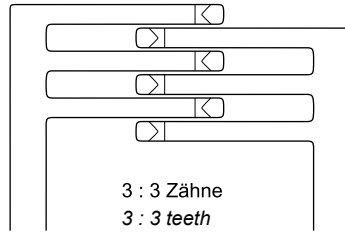
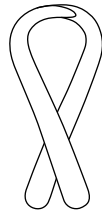

3 : 3 Zähne
3 : 3 teeth
scharf
sharp

24 cm – 9½"

ZA 4732-24



CONE

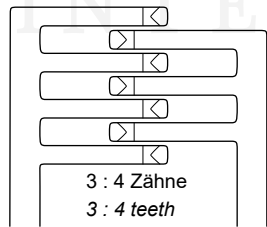

3 : 4 Zähne
3 : 4 teeth

scharf stumpf
sharp blunt

21 cm – 8¼"

ZA 4734-20

ZA 4735-20

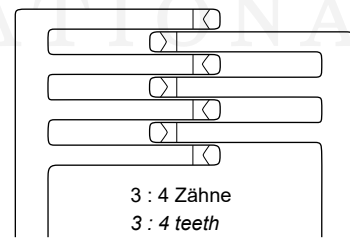

3 : 4 Zähne
3 : 4 teeth

scharf stumpf
sharp blunt

25 cm – 10"

ZA 4734-26

ZA 4735-26



Wundspreizer Self-retaining Retractors



TRAVERS

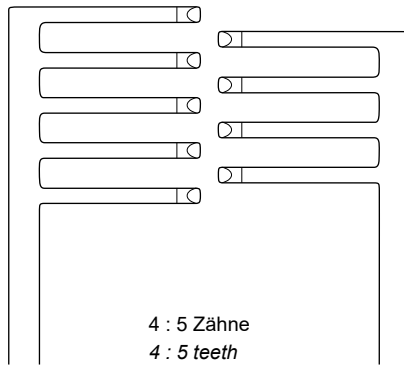
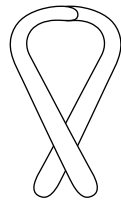

4 : 5 Zähne
4 : 5 teeth

stumpf
blunt

21 cm – 8¼"

ZA 4738-21

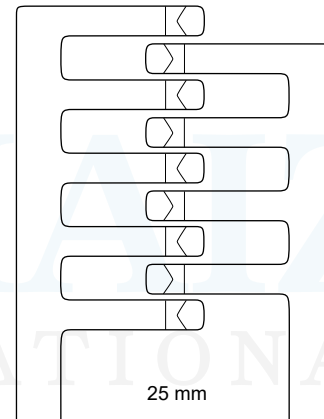

25 mm

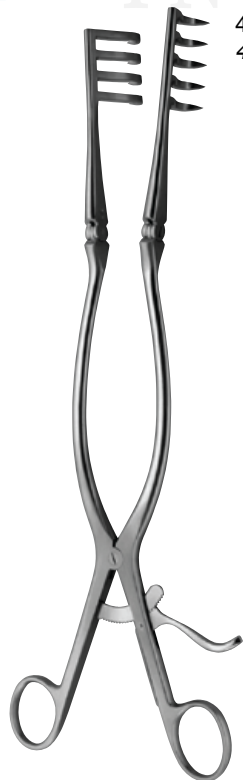

BECKMANN-ADSON

4 : 5 Zähne
4 : 5 teeth

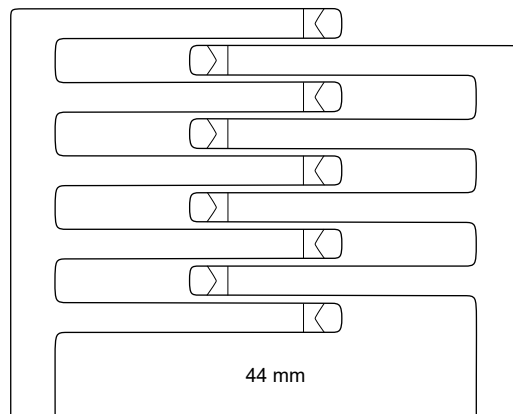

44 mm

scharf
sharp

stumpf
blunt

31 cm – 12¼"

25mm	ZA 4739-01	ZA 4739-11	ZA 4739-21
44mm	ZA 4739-02	ZA 4739-12	ZA 4739-22



Wundspreizer Self-retaining Retractors

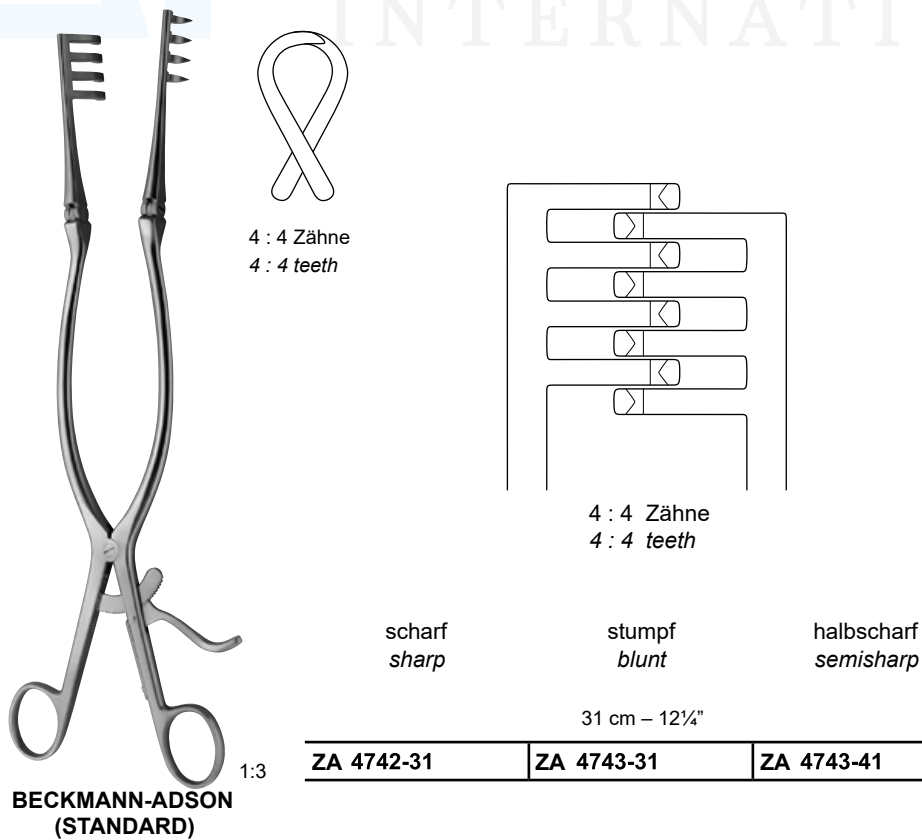
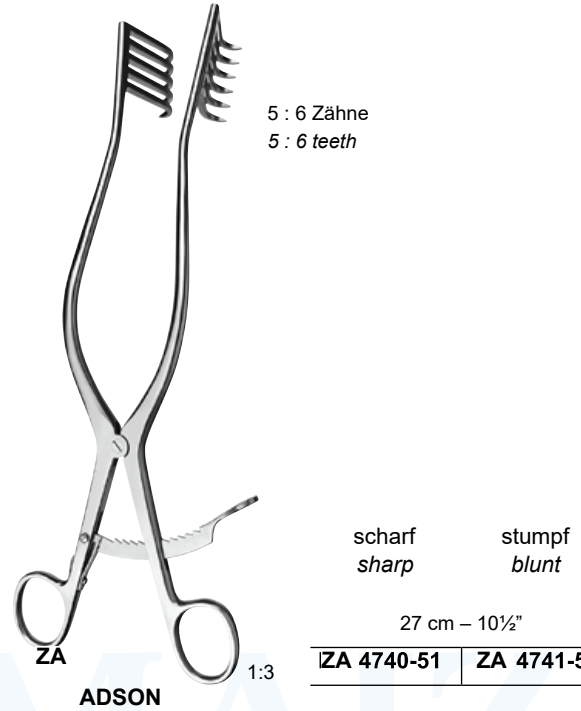

Wundspreizer Self-retaining Retractors



ADSON

1:3

stumpf
blunt

33 cm – 13"

ZA 4743-33



Hemilaminektome-Sperrer
Hemilaminectomy retractor

scharf
sharp

28 cm – 11"

ZA 4745-27

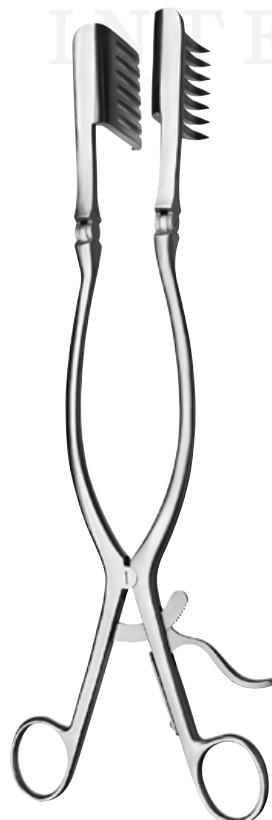

BECKMANN-EATON

1:3

scharf
sharp

33 cm – 13"

ZA 4749-33



Spezialwundspreizer Special Retractors



Schilddrüsen- und
Vulvaspreizer
*Thyroid- and vag-
inal retractor*

15,5 cm – 6"

ZA 4761-00

JOLL (FRIEDMANN)



Haut- und Vulvaspreizer
Skin- and vaginal retractor

9,5 cm – 3¾"	ZA 4761-09
12 cm – 4¾"	ZA 4761-11
13,5 cm – 5¼"	ZA 4761-13
19 cm – 7½"	ZA 4761-19

GELPI



Haut- und
Vulvaspreizer
*Skin- and
vaginal retractor*

19 cm – 7½"

ZA 4763-19

GELPI



Blätterblades | 19 cm – 7"

32 x 25 mm	ZA 4764-01
54 x 25 mm	ZA 4764-02
60 x 25 mm	ZA 4764-04

MEYERDING

Wundspreizer Self-retaining Retractors



MARHAM-MEYERDING

18 cm – 7"

ZA 4765-01

ZA 4765-02



RIGBY

19 cm – 7½"

ZA 4767-19



DE BAKEY

12 cm – 4¾" | **ZA 4768-12**

17 cm – 6¾" | **ZA 4768-17**



Bauchdeckenhalter Abdominal Retractors



COLLIN

Sperrer allein,
Spreizweite: 100 mm
*Retractor only,
spread: 100 mm*

ZA 4750-50

Bauchdeckenhalter komplett mit
einem Paar Blätter ZA 4750-51
*Abdominal retractor complete with
one pair of blades ZA 4750-51*

ZA 4750-00

Blätter seitlich, 1 Paar (38 x 60 mm)
Blades lateral, 1 pair (38 x 60 mm)

ZA 4750-51



BABY-COLLIN

Bauchdeckenhalter (Spreizweite: 80 mm) komplett mit
2 Paar Blätter (28 x 42 mm, 18 x 42 mm)
*Abdominal retractor (spread: 80 mm) complete with
two pairs of blades (28 x 42 mm, 18 x 42 mm)*

ZA 4751-00

Blätter seitlich, 1 Paar (18 x 42 mm)
Blades lateral, 1 pair (18 x 42 mm)

ZA 4751-51

Blätter seitlich, 1 Paar (28 x 42 mm)
Blades lateral, 1 pair (28 x 42 mm)

ZA 4751-52



Fig. 1

Sperrer allein, Spreizweite: 110 mm <i>Retractor only, spread: 110 mm</i>	ZA 4752-50
---	-------------------

Bauchdeckenhalter komplett, bestehend aus: <i>Abdominal retractor complete, consisting of:</i>	ZA 4752-00
---	-------------------

Sperrer allein (ZA 4752-50) <i>Retractor only (ZA 4752-50)</i>	
1 Paar Blätter seitlich, 38 x 62 mm (ZA 4752-51) 1 pair of blades lateral, 38 x 62 mm (MA 4752-51)	
1 Mittelblatt, 55 x 55 mm (ZA 4752-55) 1 Central blade, 55 x 55 mm (ZA 4752-55)	



COLLIN

Fig. 2

Sperrer allein, Spreizweite: 110 mm <i>Retractor only, spread: 110 mm</i>	ZA 4754-50
---	-------------------

Bauchdeckenhalter komplett, bestehend aus: <i>Abdominal retractor complete, consisting of:</i>	ZA 4754-00
---	-------------------

Sperrer allein (ZA 4754-50) <i>Retractor only (ZA 4754-50)</i>	
1 Paar Blätter seitlich, 38 x 80 mm (ZA 4754-51) 1 pair of blades lateral, 38 x 80 mm (ZA 4754-51)	

ZA

Fig. 3

Sperrer allein, Spreizweite: 110 mm <i>Retractor only, spread: 110 mm</i>	ZA 4754-60
---	-------------------

Bauchdeckenhalter komplett, bestehend aus: <i>Abdominal retractor complete, consisting of:</i>	ZA 4754-10
---	-------------------

Sperrer allein (ZA 4754-60) <i>Retractor only (ZA 4754-60)</i>	
1 Paar Blätter seitlich, 38 x 100 mm (ZA 4754-61) 1 pair of blades lateral, 38 x 100 mm (ZA 4754-61)	
1 Mittelblatt, 55 x 75 mm (ZA 4754-65) 1 Central blade, 55 x 75 mm (ZA 4754-65)	



Bauchdeckenhalter Abdominal Retractors

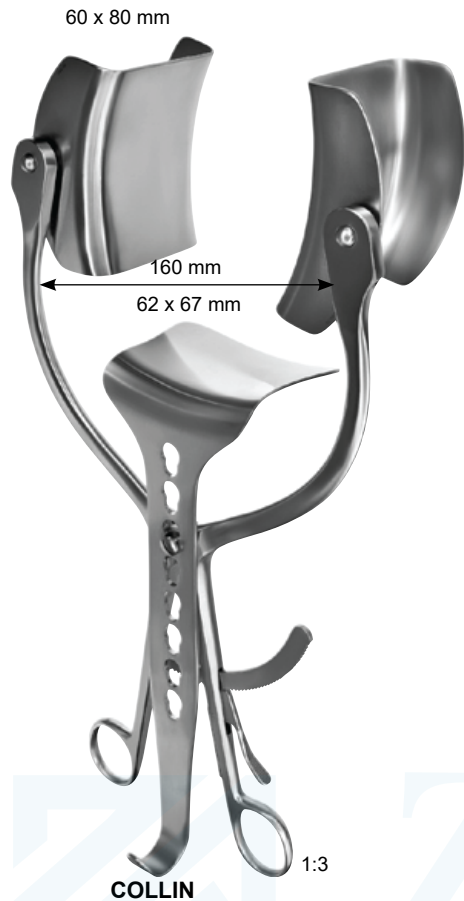

Sperrer allein
Retractor only

ZA 4754-76

Bauchdeckenhalter komplett, bestehend aus:
Abdominal retractor complete, consisting of:

ZA 4754-70

Sperrer allein (ZA 4754-76)
Retractor only (ZA 4754-76)

1 Paar Blätter seitlich, 60 x 80 mm (ZA 4754-71)

1 pair of blades lateral, 60 x 80 mm (ZA 4754-71)

1 Mittelblatt, 62 x 67 mm (ZA 4754-75)

1 Central blade, 62 x 67 mm (ZA 4754-75)



ZIMAIZ
INTERNATIONAL

Bauchdeckenhalter Abdominal Retractors



Fig. 1

Sperrer allein <i>Retractor only</i>	ZA 4758-11
Bauchdeckenhalter komplett, bestehend aus: <i>Abdominal retractor complete, consisting of:</i>	ZA 4758-01
Sperrer allein (ZA 4758-11) <i>Retractor only (ZA 4758-11)</i>	
1 Paar Blätter seitlich, 60 x 80 mm (ZA 4758-21) 1 pair of blades lateral, 60 x 80 mm (ZA 4758-21)	
1 Mittelblatt, 53 x 70 mm (ZA 4758-31) 1 Central blade, 53 x 70 mm (ZA 4758-31)	

Fig. 2

Sperrer allein <i>Retractor only</i>	ZA 4758-11
Bauchdeckenhalter komplett, bestehend aus: <i>Abdominal retractor complete, consisting of:</i>	ZA 4758-02
Sperrer allein (ZA 4758-11) <i>Retractor only (ZA 4758-11)</i>	
1 Paar Blätter seitlich, 72 x 85 mm (ZA 4758-22) 1 pair of blades lateral, 72 x 85 mm (ZA 4758-22)	
1 Mittelblatt, 80 x 90 mm (ZA 4758-32) 1 Central blade, 80 x 90 mm (ZA 4758-32)	



Bauchdeckenhalter Abdominal Retractors

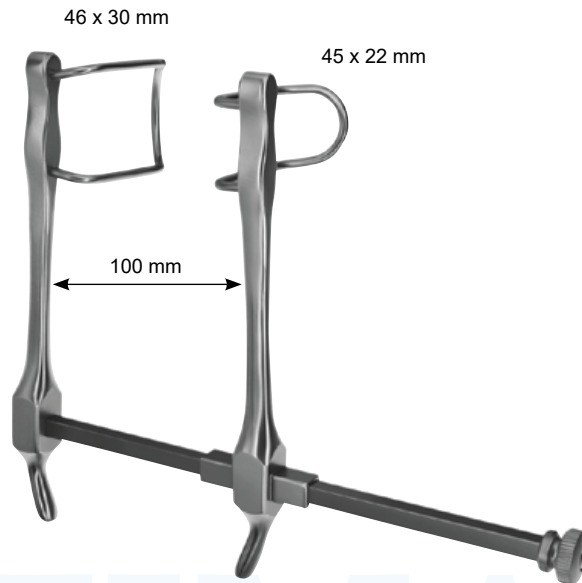

GOSSET
ZA 4769-00



GOSSET
ZA 4770-02

Bauchdeckenhalter Abdominal Retractors



GOSSET

Sperrer allein <i>Retractor only</i>	ZA 4771-11
Bauchdeckenhalter komplett, bestehend aus: <i>Abdominal retractor complete, consisting of:</i>	ZA 4771-00
Sperrer allein (ZA 4771-11) <i>Retractor only (ZA 4771-11)</i>	
1 Mittelblatt, 65 x 60 mm (ZA 4771-21) 1 Central blade, 65 x 60 mm (ZA 4771-21)	



FRAZIER ZA 4774-00



Bauchdeckenhalter Abdominal Retractors

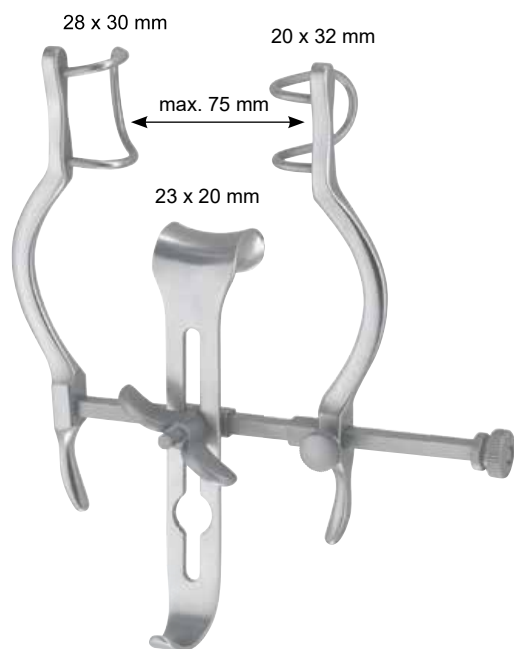

BABY-BALFOUR

Sperrer allein, Spreizweite: 75 mm <i>Retractor only, Spread: 75 mm</i>	ZA 4798-11
---	-------------------

Sperrer komplett, bestehend aus: <i>Retractor complete, consisting of:</i>	ZA 4798-00
---	-------------------

Sperrer allein (ZA 4798-11)
Retractor only (ZA 4798-11)

Mittelblatt (ZA 4798-21)
Central blade (ZA 4798-21)



BALFOUR

Sperrer allein, Spreizweite: 150 mm <i>Retractor only, Spread: 150 mm</i>	ZA 4800-11
---	-------------------

Sperrer komplett, bestehend aus: <i>Retractor complete, consisting of:</i>	ZA 4800-00
---	-------------------

Sperrer allein (ZA 4800-11)
Retractor only (ZA 4800-11)

Mittelblatt (ZA 4800-21)
Central blade (ZA 4800-21)

Bauchdeckenhalter Abdominal Retractors

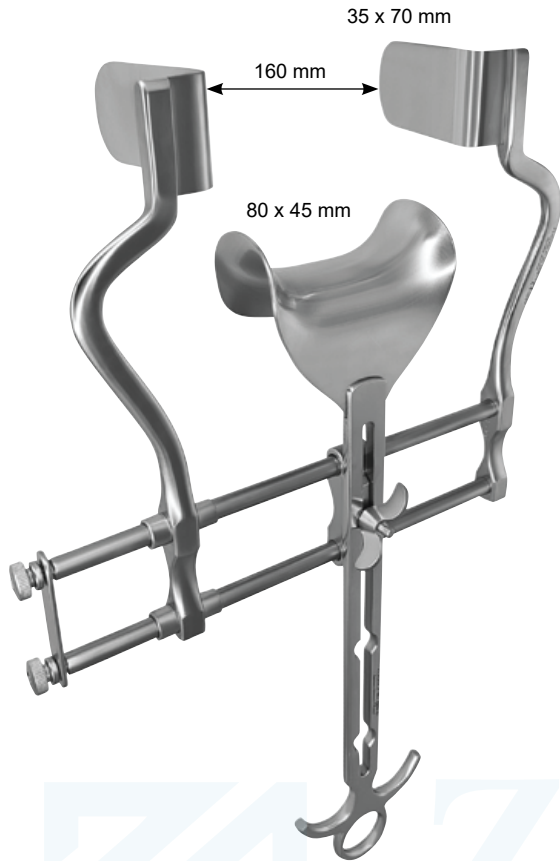

BALFOUR

Sperrer allein, Spreizweite: 160 mm <i>Retractor only, spread: 160 mm</i>	ZA 4802-11
---	-------------------

Sperrer komplett, bestehend aus: <i>Retractor complete, consisting of:</i>	ZA 4802-00
---	-------------------

Sperrer allein (ZA 4802-11)
Retractor only (ZA 4802-11)
Mittelblatt (ZA 4802-21)
Central blade (ZA 4802-21)

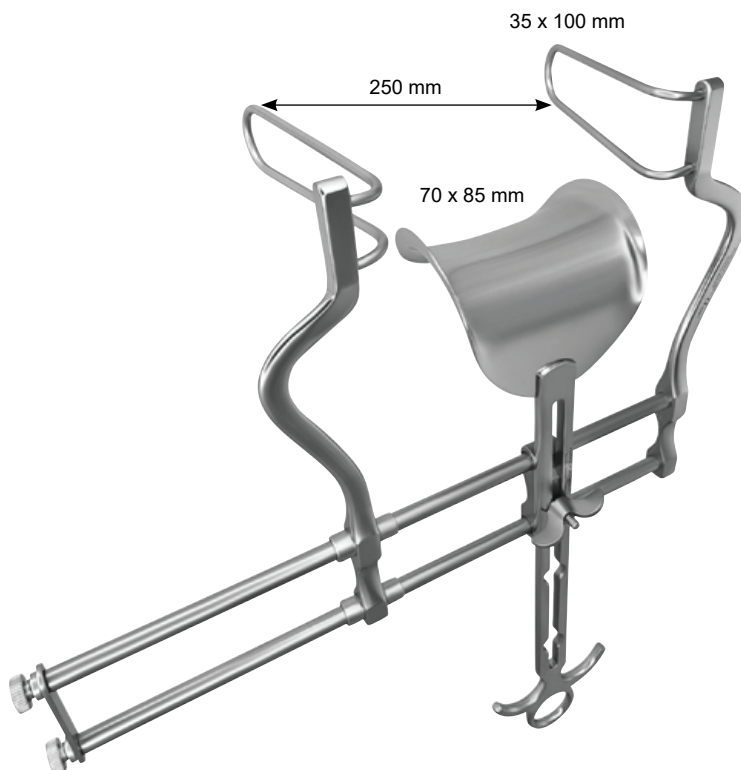

BALFOUR

Sperrer allein, Spreizweite: 250 mm <i>Retractor only, spread: 250 mm</i>	ZA 4804-11
---	-------------------

Sperrer komplett, bestehend aus: <i>Retractor complete, consisting of:</i>	ZA 4804-00
---	-------------------

Sperrer allein (ZA 4804-11)
Retractor only (ZA 4804-11)
Mittelblatt (ZA 4804-21)
Central blade (ZA 4804-21)



Bauchdeckenhalter Abdominal Retractors

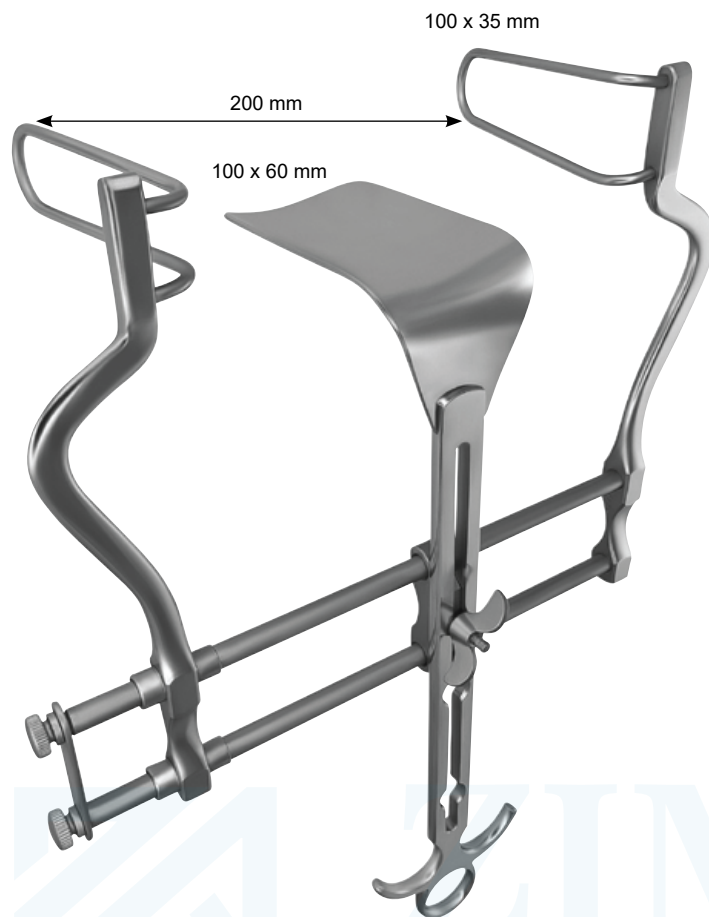

BALFOUR

Sperrer allein, Spreizweite: 200 mm <i>Retractor only, Spread: 200 mm</i>	ZA 4806-11
---	-------------------

Sperrer komplett, bestehend aus: <i>Retractor complete, consisting of:</i>	ZA 4806-00
---	-------------------

Sperrer allein (ZA 4806-11)
Retractor only (ZA 4806-11)
Mittelblatt (ZA 4806-21)
Central blade (ZA 4806-21)



BALFOUR USA-MODELL BALFOUR USA-PATTERN

Sperrer allein <i>Retractor only</i>	ZA 4807-11
---	-------------------

Sperrer komplett, bestehend aus: <i>Retractor complete, consisting of:</i>	ZA 4807-00
---	-------------------

Sperrer allein (ZA 4807-11)
Retractor only (ZA 4807-11)
2 Blätter seitlich, 60 mm (ZA 4807-31)
2 *Blades lateral, 60 mm* (ZA 4807-31)
2 Blätter seitlich, 80 mm (ZA 4807-32)
2 *Blades lateral, 80 mm* (ZA 4807-32)
1 Mittelblatt, 45 x 68 mm (ZA 4807-21)
1 Central blade, 45 x 68 mm (ZA 4807-21)
1 Mittelblatt, 68 x 85 mm (ZA 4807-22)
1 Central blade, 68 x 85 mm (ZA 4807-22)

Bauchdeckenhalter Abdominal Retractors



SEMM

Bauchdeckenhalter komplett,
bestehend aus:
*Abdominal retractor complete,
consisting of:*

ZA 4810-00

Rahmen (ZA 4810-10)
Frame (ZA 4810-10)

2 Blätter (ZA 4810-01)
2 Blades (ZA 4810-01)

1 Blätter (ZA 4810-02)
1 Blades (ZA 4810-02)

1 Blätter (ZA 4810-03)
1 Blades (ZA 4810-03)

1 Blätter (ZA 4810-04)
1 Blades (ZA 4810-04)

1 Blätter (ZA 4810-05)
1 Blades (ZA 4810-05)

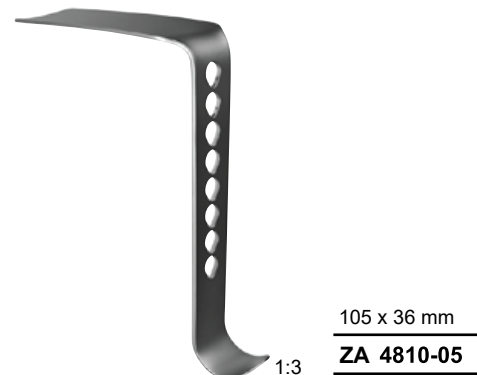
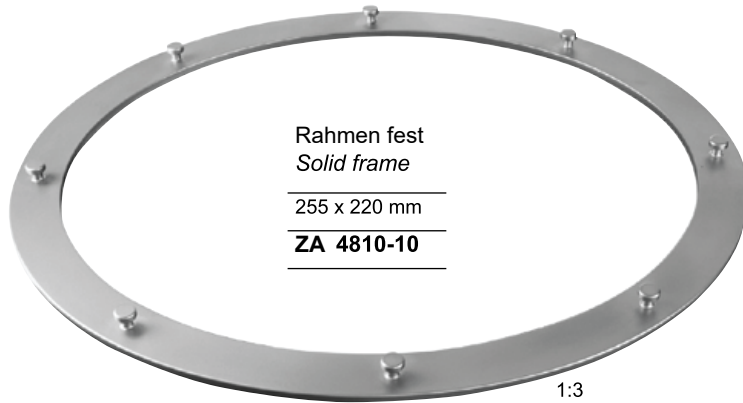



Bauchdeckenhalter Abdominal Retractors

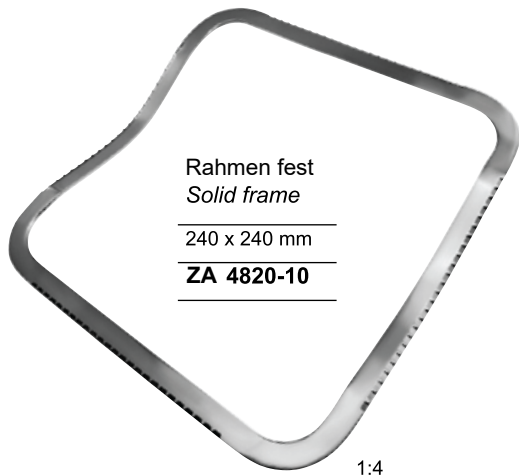

Rahmen fest
Solid frame
240 x 240 mm
ZA 4820-10

1:4

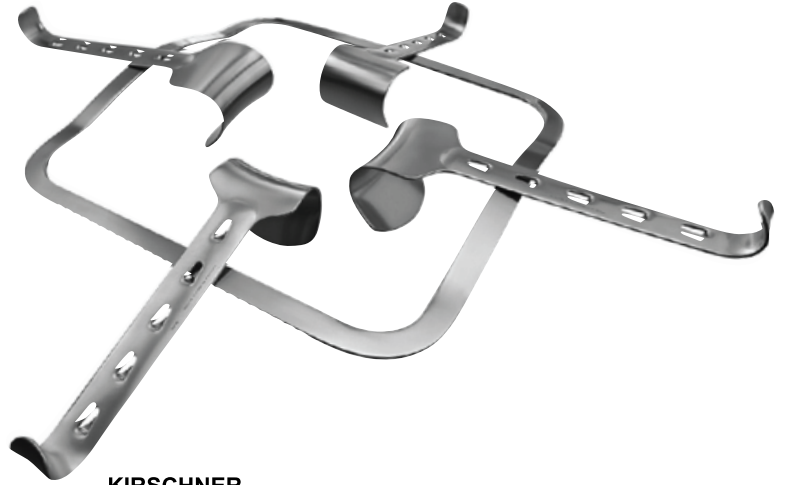

KIRSCHNER

Bauchdeckenhalter komplett, bestehend aus: <i>Abdominal retractor complete, consisting of:</i>	ZA 4820-00
---	-------------------

- Rahmen fest (ZA 4820-10)
Solid frame (ZA 4820-10)
- 2 Blätter, 40 x 55 mm (ZA 4822-01)
2 Blades, 40 x 55 mm (ZA 4822-01)
- 2 Blätter, 50 x 65 mm (ZA 4822-02)
2 Blades, 50 x 65 mm (ZA 4822-02)



Rahmen zusammenlegbar
Foldable frame
240 x 240 mm
ZA 4821-10

1:4

KIRSCHNER

Bauchdeckenhalter komplett, bestehend aus: <i>Abdominal retractor complete, consisting of:</i>	ZA 4821-00
---	-------------------

- Rahmen zusammenlegbar (ZA 4821-10)
Foldable frame (ZA 4821-10)
- 2 Blätter, 40 x 55 mm (ZA 4822-01)
2 Blades, 40 x 55 mm (ZA 4822-01)
- 2 Blätter, 50 x 65 mm (ZA 4822-02)
2 Blades, 50 x 65 mm (ZA 4822-02)



1:3

	Blätter <i>Blades</i>
40 x 55 mm	ZA 4822-01
50 x 65 mm	ZA 4822-02
65 x 80 mm	ZA 4822-03
80 x 80 mm	ZA 4822-04
90 x 65 mm	ZA 4822-05
90 x 90 mm	ZA 4822-06

Bauchdeckenhalter Abdominal Retractors

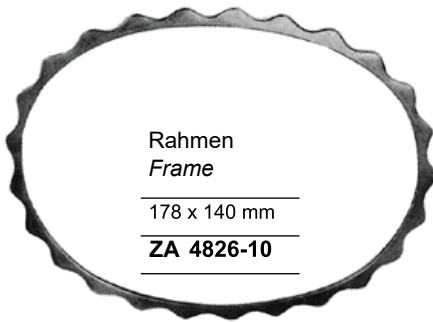

Rahmen
Frame
178 x 140 mm
ZA 4826-10

DENIS-BROWN

Bauchdeckenhalter komplett, bestehend aus:
Abdominal retractor complete, consisting of:

ZA 4826-00

Rahmen 178 x 140 mm (ZA 4826-10)
Frame 178 x 140 mm (ZA 4826-10)

2 Blätter, Fig. 1, 40 x 40 mm (ZA 4828-01)
2 Blades, fig. 1, 40 x 40 mm (ZA 4828-01)

2 Blätter, Fig. 2, 40 x 30 mm (ZA 4828-02)
2 Blades, fig. 2, 40 x 30 mm (ZA 4828-02)



1:3

40 x 40 mm

Blatt, Fig. 1
Blade, fig. 1

ZA 4828-01



1:3

40 x 30 mm

Blatt, Fig. 2
Blade, fig. 2

ZA 4828-02

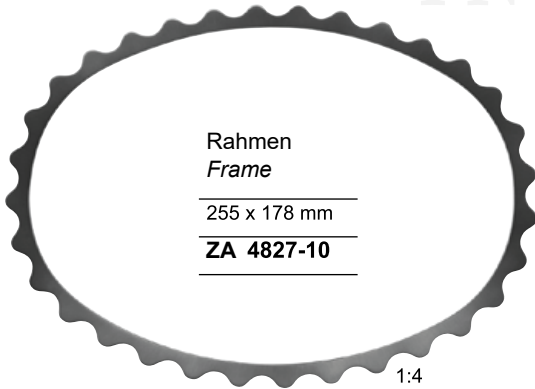

Rahmen
Frame
255 x 178 mm
ZA 4827-10

1:4

DENIS-BROWN

Bauchdeckenhalter komplett, bestehend aus:
Abdominal retractor complete, consisting of:

ZA 4827-00

Rahmen 255 x 178 mm (ZA 4827-10)
Frame 255 x 178 mm (ZA 4827-10)

2 Blätter, Fig. 1, 40 x 40 mm (ZA 4828-01)
2 Blades, fig. 1, 40 x 40 mm (ZA 4828-01)

2 Blätter, Fig. 2, 40 x 30 mm (ZA 4828-02)
2 Blades, fig. 2, 40 x 30 mm (ZA 4828-02)



1:3

40 x 40 mm

Blatt, Fig. 1
Blade, fig. 1

ZA 4828-01



1:3

40 x 30 mm

Blatt, Fig. 2
Blade, fig. 2

ZA 4828-02



Bauchdeckenhalter Abdominal Retractors

O'SULLIVAN-O'CONNOR

Bauchdeckenhalter komplett, bestehend aus:
Abdominal retractor complete, consisting of:

ZA 4829-00

2 Mittelblätter, 80 x 45 mm (ZA 4829-22)

2 Central blades, 80 x 45 mm (ZA 4829-22)

1 Mittelblatt, 110 x 70 mm (ZA 4829-23)

1 Central blade, 110 x 70 mm (ZA 4829-23)

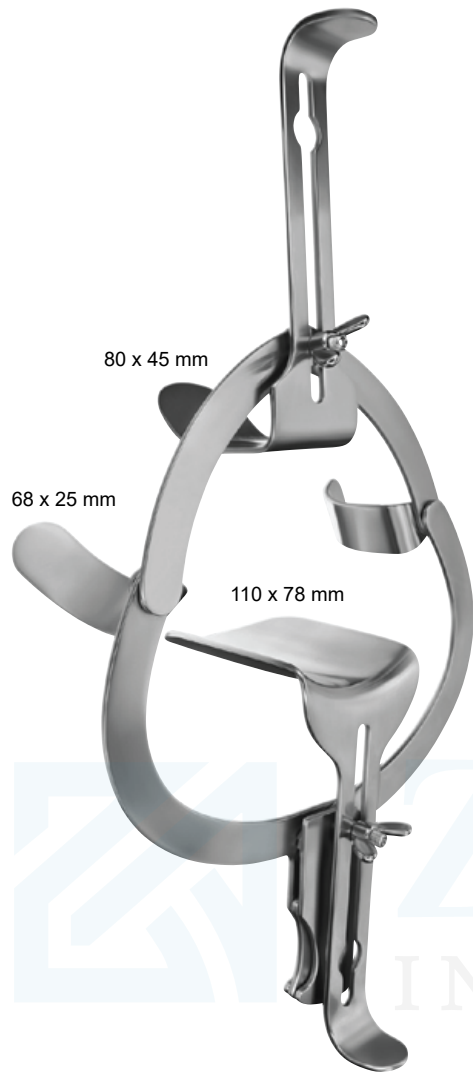

80 x 45 mm

ZA 4829-22

110 x 70 mm

ZA 4829-23

Bauchdeckenhalter Abdominal Retractors

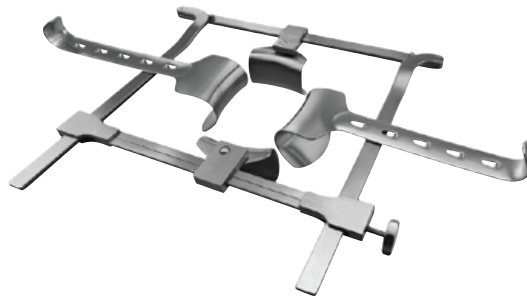

FRANZ

Bauchdeckenhalter komplett,
bestehend aus:

*Abdominal retractor complete,
consisting of:*

ZA 4830-04

Rahmen zusammenlegbar (ZA 4830-10)
Foldable frame (ZA 4830-10)

2 Blätter, 38 x 60 mm (ZA 4832-01)

2 Blades, 38 x 60 mm (ZA 4832-01)

2 Blätter, 50 x 65 mm (ZA 4833-01)

2 Blades, 50 x 65 mm (ZA 4833-01)

FRANZ

Bauchdeckenhalter komplett,
bestehend aus:

*Abdominal retractor complete,
consisting of:*

ZA 4830-08

Rahmen zusammenlegbar (ZA 4830-10)
Foldable frame (ZA 4830-10)

2 Blätter, 38 x 60 mm (ZA 4832-01)

2 Blades, 38 x 60 mm (ZA 4832-01)

2 Blätter, 50 x 65 mm (ZA 4833-01)

2 Blades, 50 x 65 mm (ZA 4833-01)

2 Blätter, 45 x 80 mm (ZA 4832-02)

2 Blades, 45 x 80 mm (ZA 4832-02)

2 Blätter, 60 x 85 mm (ZA 4833-02)

2 Blades, 60 x 85 mm (ZA 4833-02)

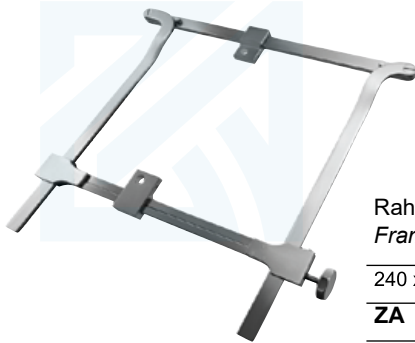

Rahmen
Frame

240 x 300 mm

ZA 4830-10



1:3

Blätter
Blades

38 x 60 mm

ZA 4832-01

45 x 80 mm

ZA 4832-02



1:3

Blätter
Blades

50 x 65 mm

ZA 4833-01

60 x 85 mm

ZA 4833-02



Bauchdeckenhalter
Abdominal retractor

DOYEN

1:3

48 x 90 mm

ZA 4834-01

48 x 105 mm

ZA 4834-02

48 x 120 mm

ZA 4834-03

48 x 135 mm

ZA 4834-04



Bauchdeckenhalter Abdominal Retractors



Befestigungsgestell
Mounting frame

1:6
ROCHARD
ZA 4835-01

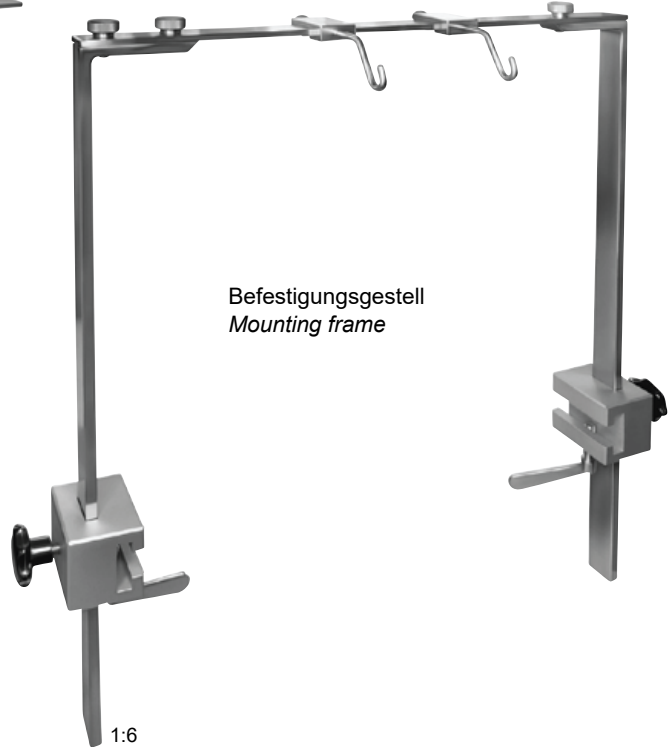

Befestigungsgestell
Mounting frame

1:6
ROCHARD
ZA 4835-02



Fixiervorrichtung
Fixation device

1:3
ROCHARD
ZA 4835-03

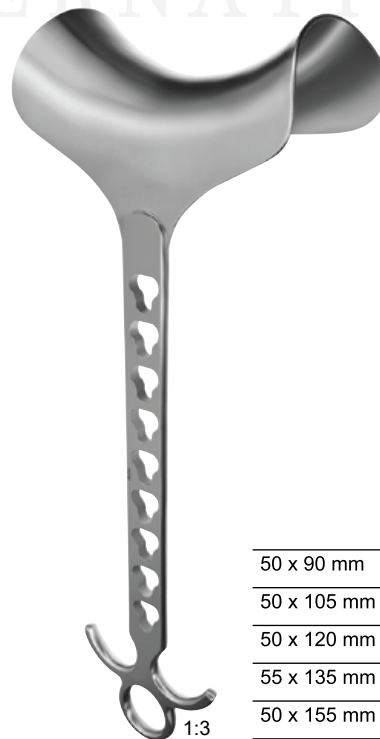

Blätter
Blades

50 x 90 mm	ZA 4835-09
50 x 105 mm	ZA 4835-10
50 x 120 mm	ZA 4835-12
55 x 135 mm	ZA 4835-13
50 x 155 mm	ZA 4835-15

1:3
ROCHARD