

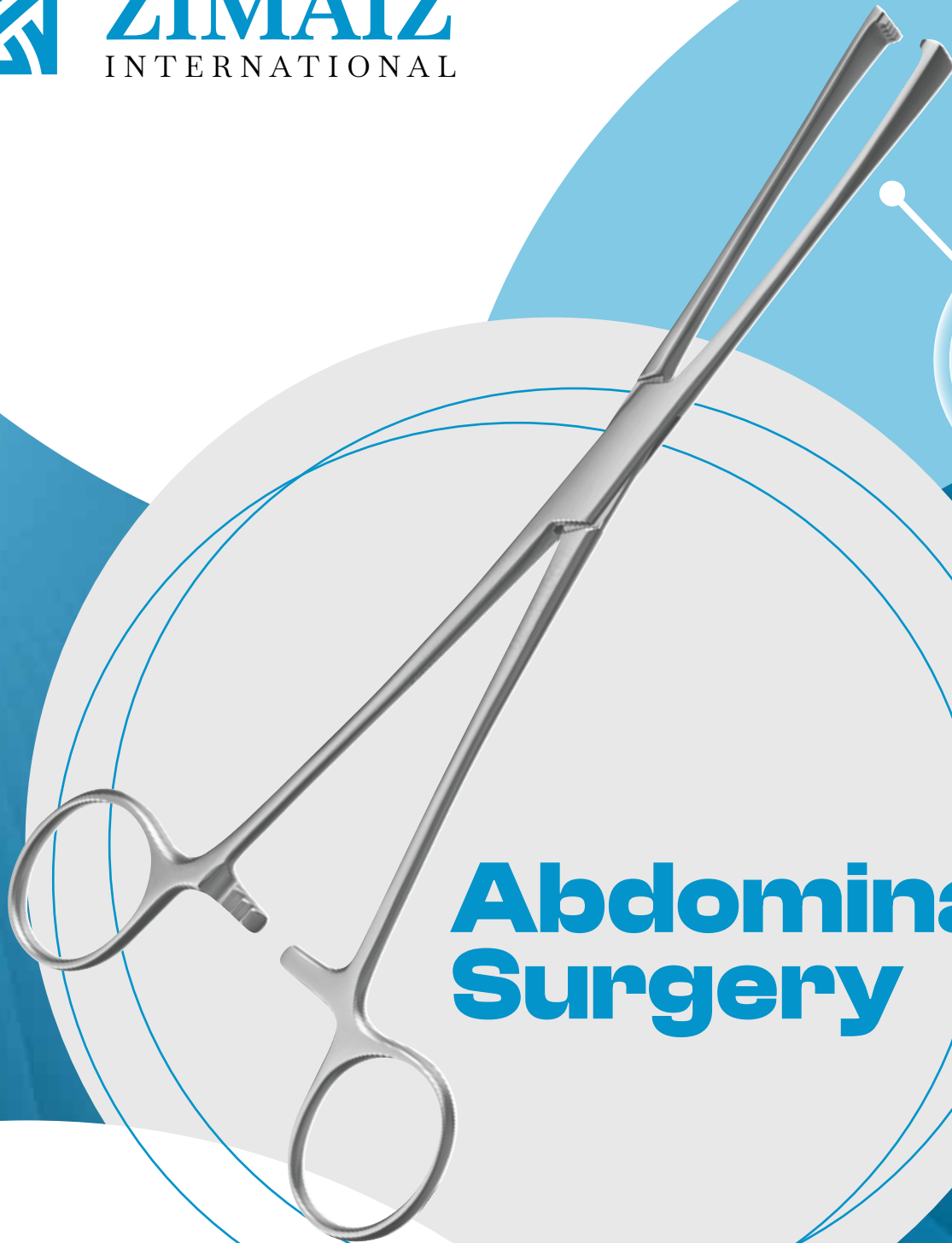

ZIMAIZ
INTERNATIONAL



Abdominal Surgery

SURGICAL
INSTRUMENTS
CATALOGUE





Abdominale Chirurgie Abdominal Surgery

Darm- und Gewebefasszangen	<i>Intestinal and Tissue Grasping Forceps</i>	AS 1 - 6
Darmklemmen	<i>Intestinal Clamps</i>	AS 7 - 13
Magenklemmen	<i>Stomach Clamps</i>	AS 14
Magen- und Darmquetschklemmen	<i>Intestinal and Pylorus Clamps</i>	AS 15
Magen- und Darm-Zwillingsklemmen	<i>Stomach and Intestinal Twin Clamps</i>	AS 16
Anastomosenklemmen	<i>Anastomosis Clamps</i>	AS 17
Rektum-Anastomosenklemmen	<i>Sigmoid Anastomosis Clamps</i>	AS 18 - 19
Rektum-Spekula	<i>Rectal Specula</i>	AS 20 - 21
Rektoskope	<i>Rectoscopes</i>	AS 22 - 23
Analspreizer	<i>Rectal Spreader</i>	AS 24
Rektum-Biopsiefasszange	<i>Rectal Biopsy Forceps</i>	AS 25
Hämorrhoidalzangen	<i>Haemorrhoidal Forceps</i>	AS 26 - 27
Hämorrhoidal-Ligatoren	<i>Haemorrhoidal Ligators</i>	AS 28 - 30
Gallenkanal-Klemmzangen	<i>Gall Duct Forceps</i>	AS 31 - 32
Gallenkanal Instrumente	<i>Gall Duct Instruments</i>	AS 33 - 34
Nierenklemmen	<i>Kidney Clamps</i>	AS 35
Nierensteinzangen	<i>Kidney Stone Forceps</i>	AS 36
Blasenwundspreizer	<i>Bladder Retractors</i>	AS 37 - 38
Urologie-Instrumente	<i>Urology Instruments</i>	AS 39 - 43

Darm- und Gewebefasszangen Intestinal and Tissue Grasping Forceps



ALLIS

	4 : 5 Zähne 4 : 5 teeth	5 : 6 Zähne 5 : 6 teeth
15 cm – 6"	ZA 6500-15	ZA 6502-15
19 cm – 7½"	–	ZA 6502-19
23 cm – 9"	–	ZA 6502-23
25 cm – 10"	–	ZA 6502-25



ZIMAIZ
INTERNATIONAL



BABY-ALLIS

	4 : 5 Zähne 4 : 5 teeth
12 cm – 4¾"	ZA 6504-12
14 cm – 5½"	ZA 6504-14



Darm- und Gewebefasszangen Intestinal and Tissue Grasping Forceps



ALLIS-ATRAUMA

16 cm – 6¼"	ZA 6505-16
20 cm – 8"	ZA 6505-20
22 cm – 8¾"	ZA 6505-22
25 cm – 10"	ZA 6505-25
30 cm – 11¾"	ZA 6505-30



ALLIS-ADAIR

15 cm – 6"	ZA 6506-15
------------	-------------------

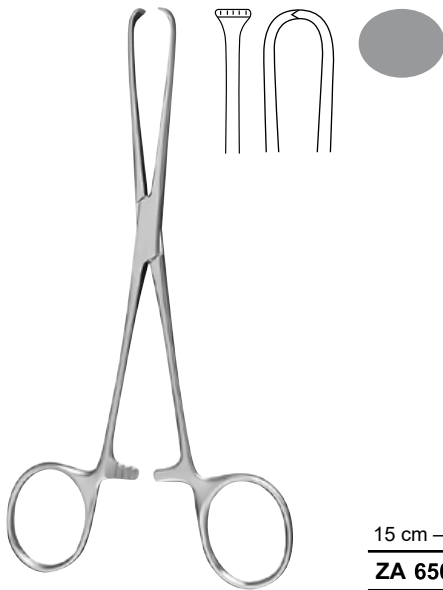

BOYS-ALLIS

15 cm – 6"	ZA 6508-15
------------	-------------------

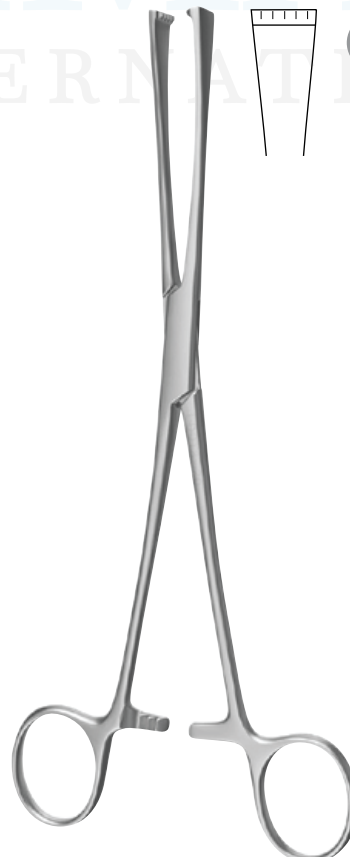

LOCKWOOD-ALLIS

	4 : 5 Zähne 4 : 5 teeth
16 cm – 6¼"	ZA 6509-16
20 cm – 8"	ZA 6509-20

Darm- und Gewebefasszangen Intestinal and Tissue Grasping Forceps

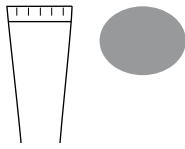

6 : 7 Zähne
6 : 7 teeth

20 cm – 8"

ZA 6510-20

THOMS-ALLIS

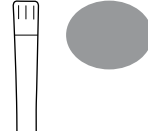

3 : 4 Zähne
3 : 4 teeth

15 cm – 6"

ZA 6512-15

19 cm – 7½"

ZA 6512-19

JUDD-ALLIS



2 : 3 Zähne
2 : 3 teeth

18,5 cm – 7¼"

ZA 6513-18

LITTLEWOOD

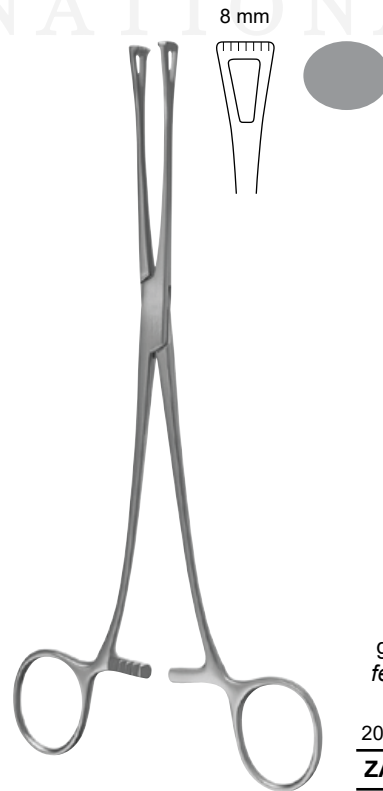

8 mm



gefenstert
fenestrated

20 cm – 8"

ZA 6515-20

LOCKWOOD

ZIMAIZ
INTERNATIONAL



Darm- und Gewebefasszangen Intestinal and Tissue Grasping Forceps

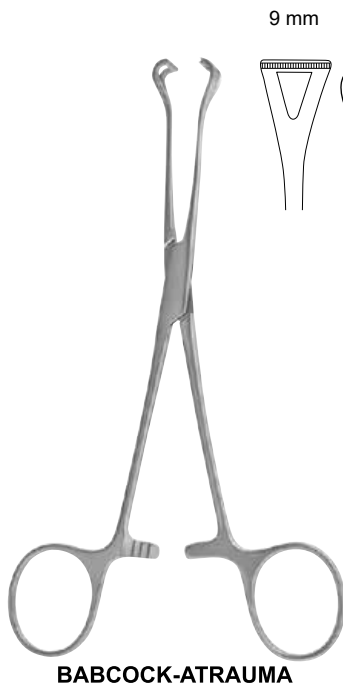

BABCOCK-ATRAUMA

16 cm – 6¼"	ZA 6517-16
20 cm – 8"	ZA 6517-20



DE BAKEY Zahnung
DE BAKEY Serration

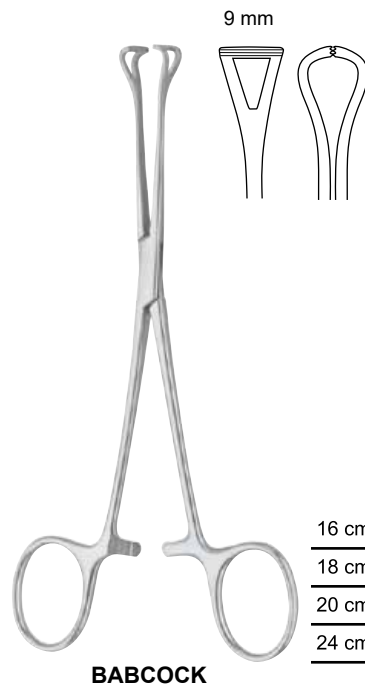

BABCOCK

16 cm – 6¼"	ZA 6518-16
18 cm – 7"	ZA 6518-18
20 cm – 8"	ZA 6518-20
24 cm – 9½"	ZA 6518-24

Standardmodell
Standard pattern

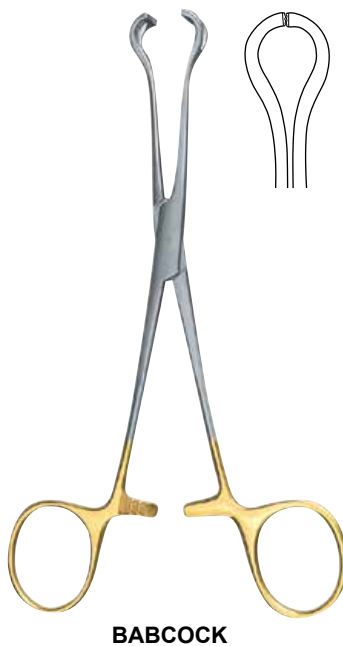

BABCOCK

	9 mm	12 mm
	16 cm – 6¼"	20 cm – 8"
TC	ZA 6519-16	ZA 6519-20

Darm- und Gewebefasszangen Intestinal and Tissue Grasping Forceps

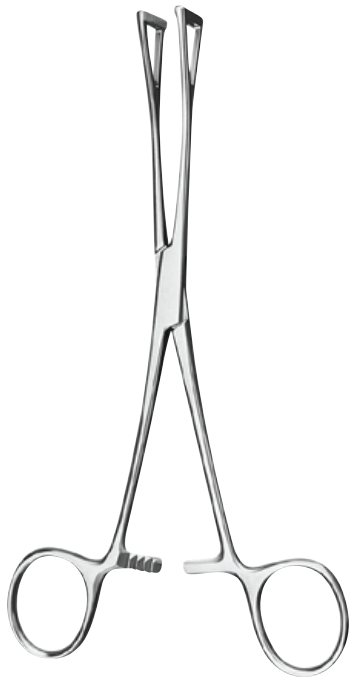

DUVAL

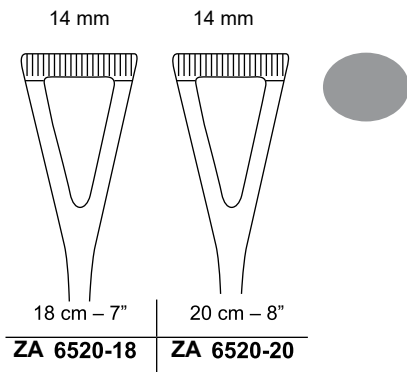

ZIMAIZ
INTERNATIONAL



COLLIN

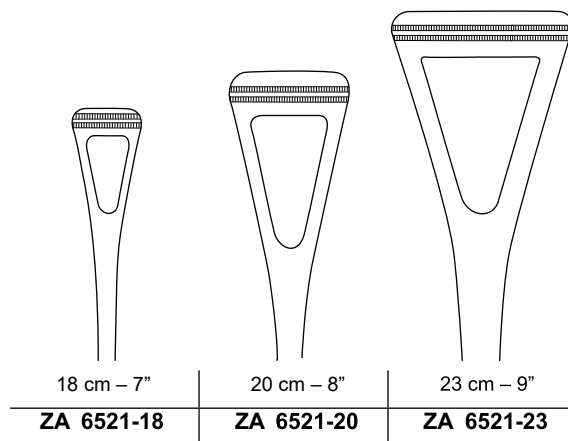



Darm- und Gewebefasszangen Intestinal and Tissue Grasping Forceps

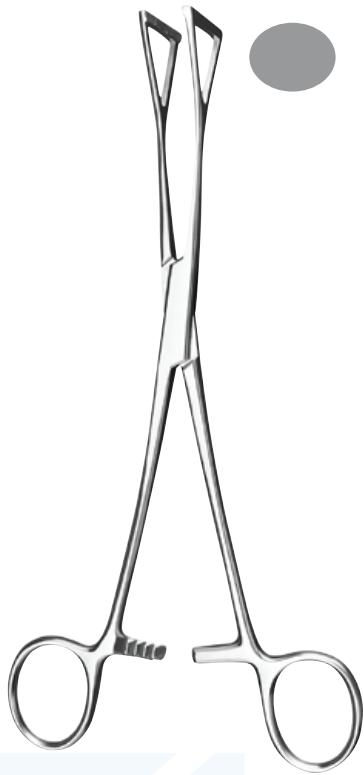

DUVAL

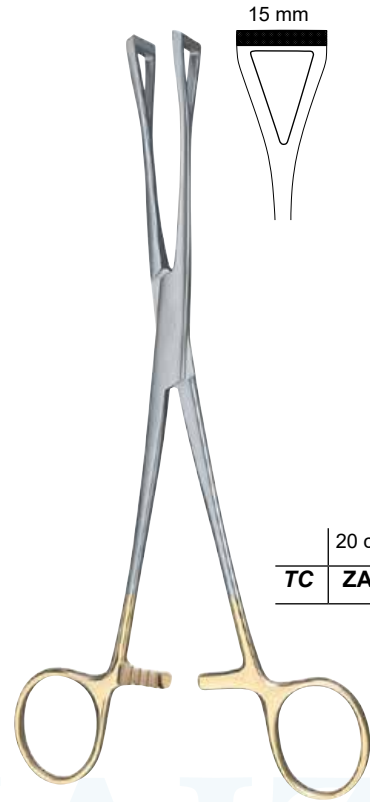
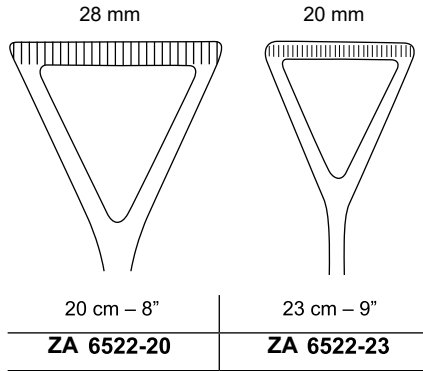

DUVAL

	20 cm – 8"
TC	ZA 6523-20

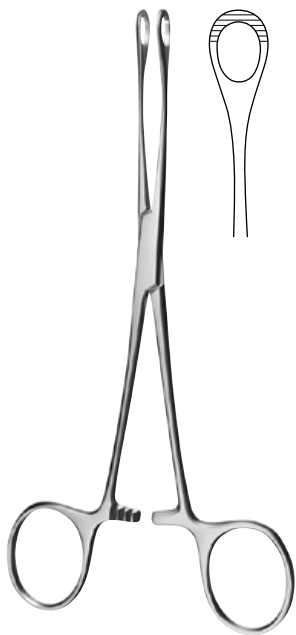

WILLIAMS

*gerade
straight*

16 cm – 6¼"
ZA 6514-16

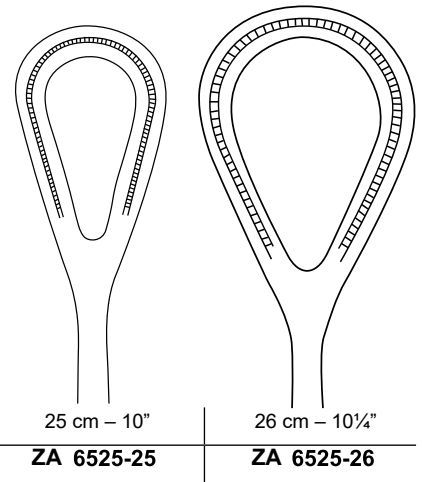



BABY-DOYEN

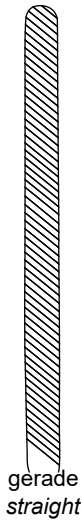

gerade
straight

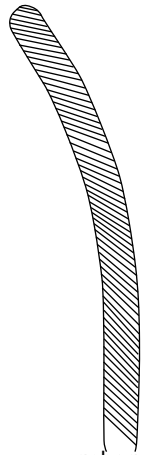

gebogen
curved

18 cm – 7"

ZA 6530-18	ZA 6531-18
-------------------	-------------------



DOYEN



gerade
straight

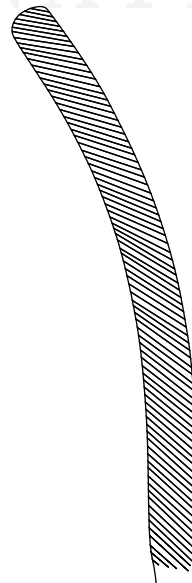

gebogen
curved

21 cm – 8¼"

ZA 6530-21

ZA 6531-21

23 cm – 9"

ZA 6530-23

ZA 6531-23



Darmklemmen Intestinal Clamps



DOYEN-ATRAUMA



DE BAKEY Zahnung
DE BAKEY Serration



13 cm – 5"

ZA 6534-13

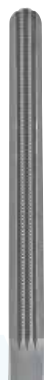

16 cm – 6¼"

ZA 6534-16



18 cm – 7"

ZA 6534-18



21 cm – 8¼"

ZA 6534-21



23 cm – 9"

ZA 6534-23



DOYEN-ATRAUMA



DE BAKEY Zahnung
DE BAKEY Serration



13 cm – 5"

ZA 6535-13



16 cm – 6¼"

ZA 6535-16



18 cm – 7"

ZA 6535-18



21 cm – 8¼"

ZA 6535-21



23 cm – 9"

ZA 6535-23

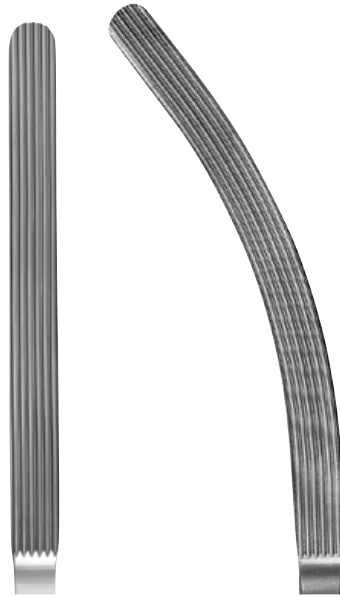

gerade
straight

gebogen
curved

21 cm – 8¼"

21 cm – 8¼"

ZA 6540-21

ZA 6541-21



MAYO-ROBSON

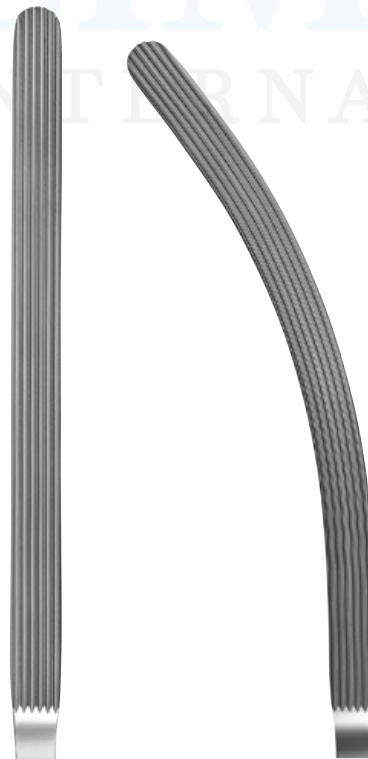

gerade
straight

gebogen
curved

23 cm – 9"

23 cm – 9"

ZA 6540-23

ZA 6541-23



Darmklemmen Intestinal Clamps

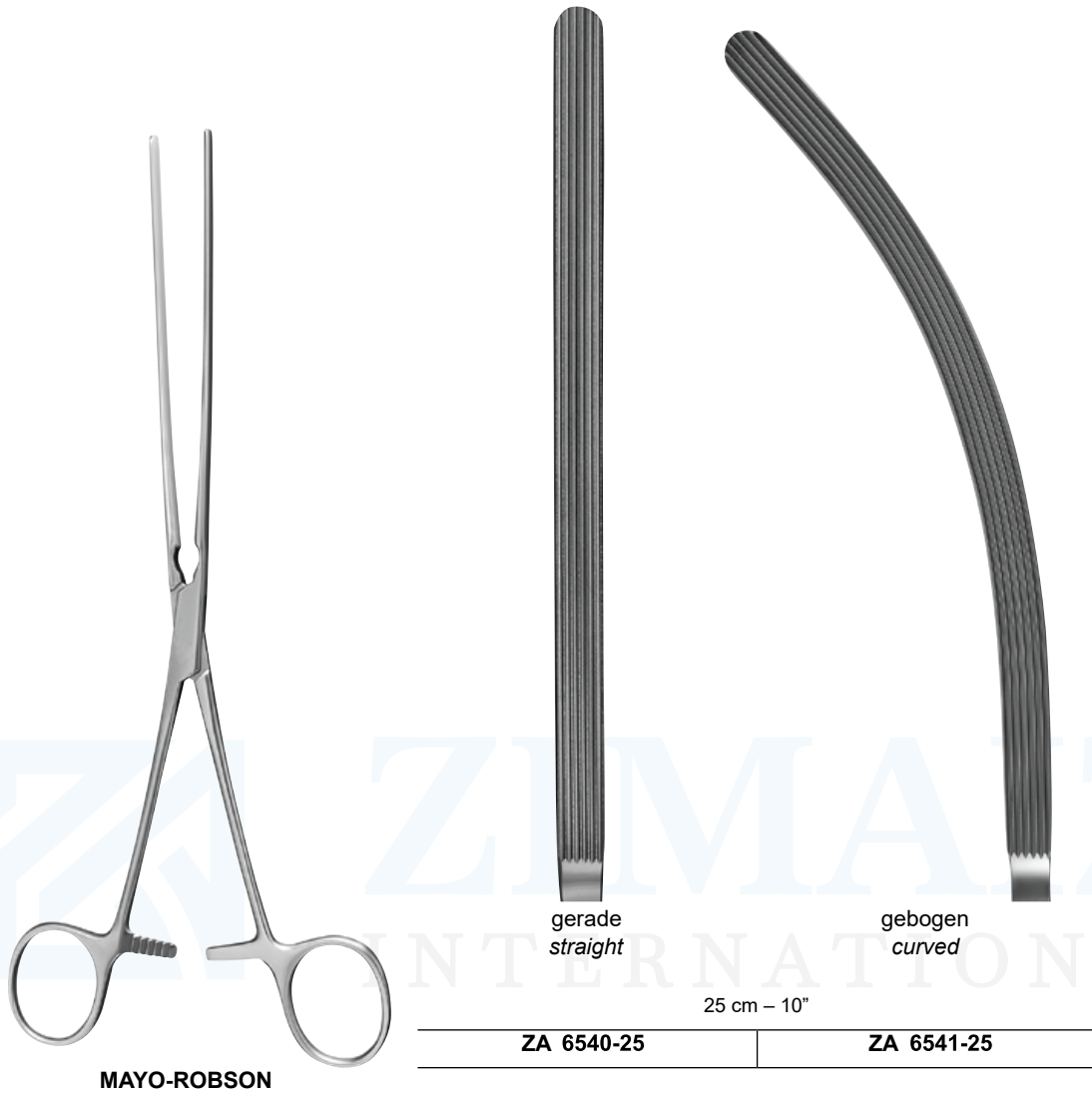



DE BAKEY Zahnung
DE BAKEY Serration



MAYO-ROBSON ATRAUMA



gerade
straight



gebogen
curved

25 cm – 10"

ZA 6542-25

ZA 6543-25



BABY-KOCHER



gerade, sehr elastisch
straight, very elastic blades



gebogen, sehr elastisch
curved, very elastic blades

13 cm – 5"

ZA 6550-13

ZA 6551-13



Darmklemmen Intestinal Clamps



Darmklemmen Intestinal Clamps



DE BAKEY Zahnung
DE BAKEY Serration



KOCHER-ATRAUMA

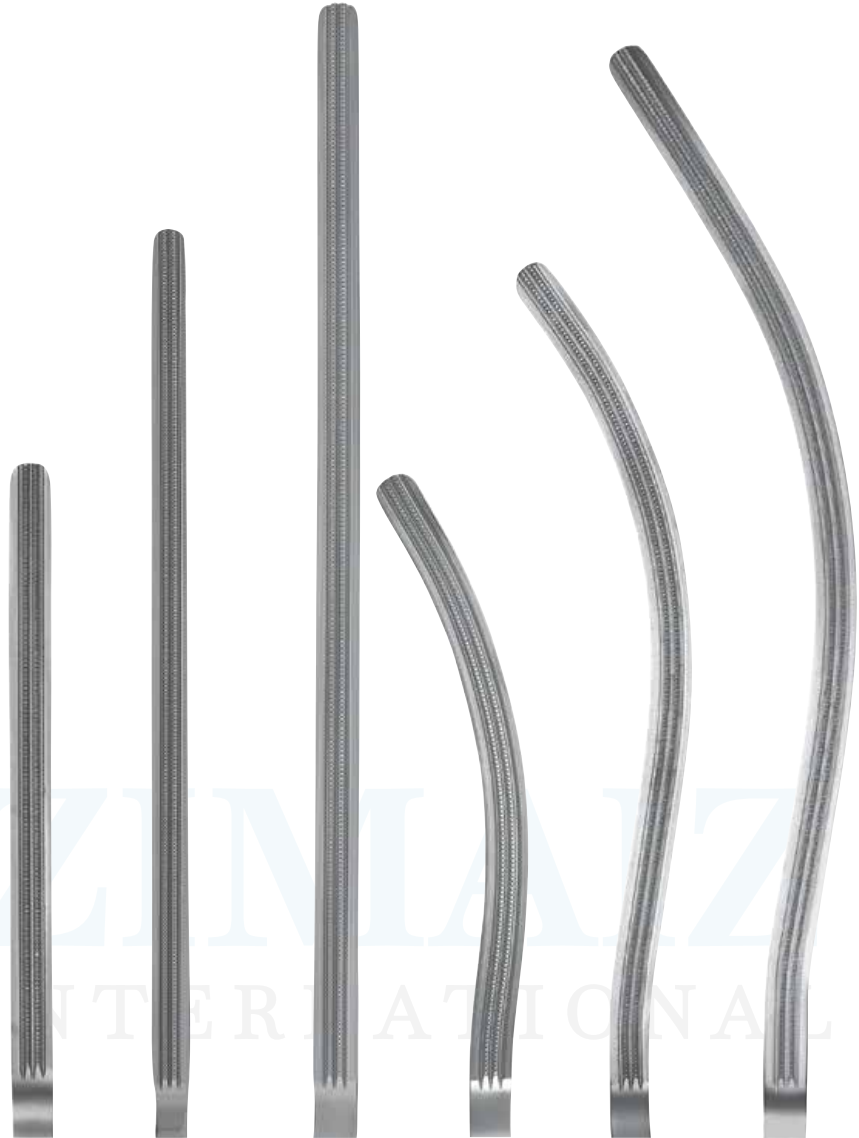

gerade
straight

gebogen
curved

22 cm – 8¾"	25 cm – 10"	28 cm – 11"	22 cm – 8¾"	25 cm – 10"	28 cm – 11"
ZA 6552-22	ZA 6552-25	ZA 6552-28	ZA 6553-22	ZA 6553-25	ZA 6553-28



Magenklemmen Stomach Clamps

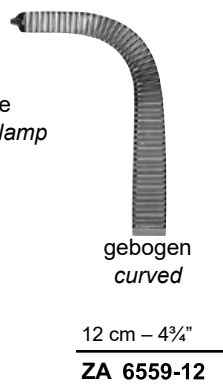
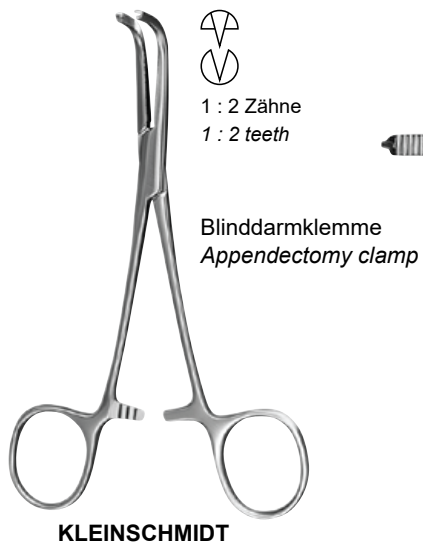
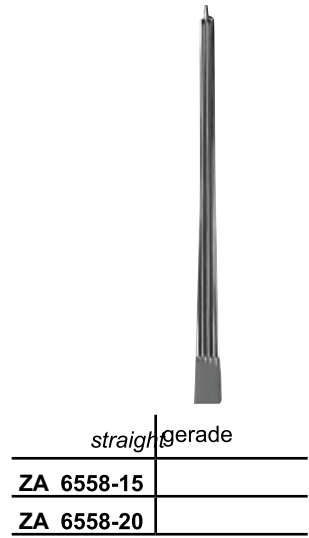
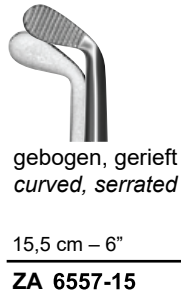
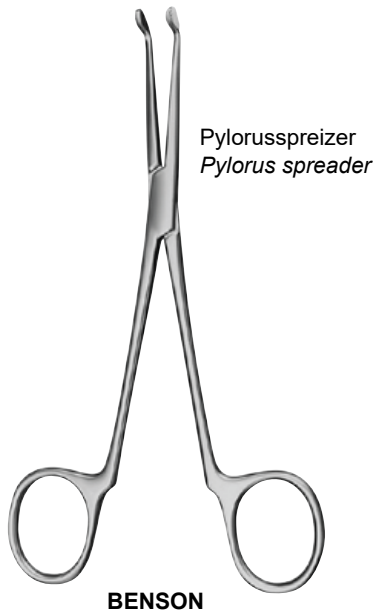

Magen- und Darmquetschklemmen Intestinal and Pylorus Clamps



PAYR

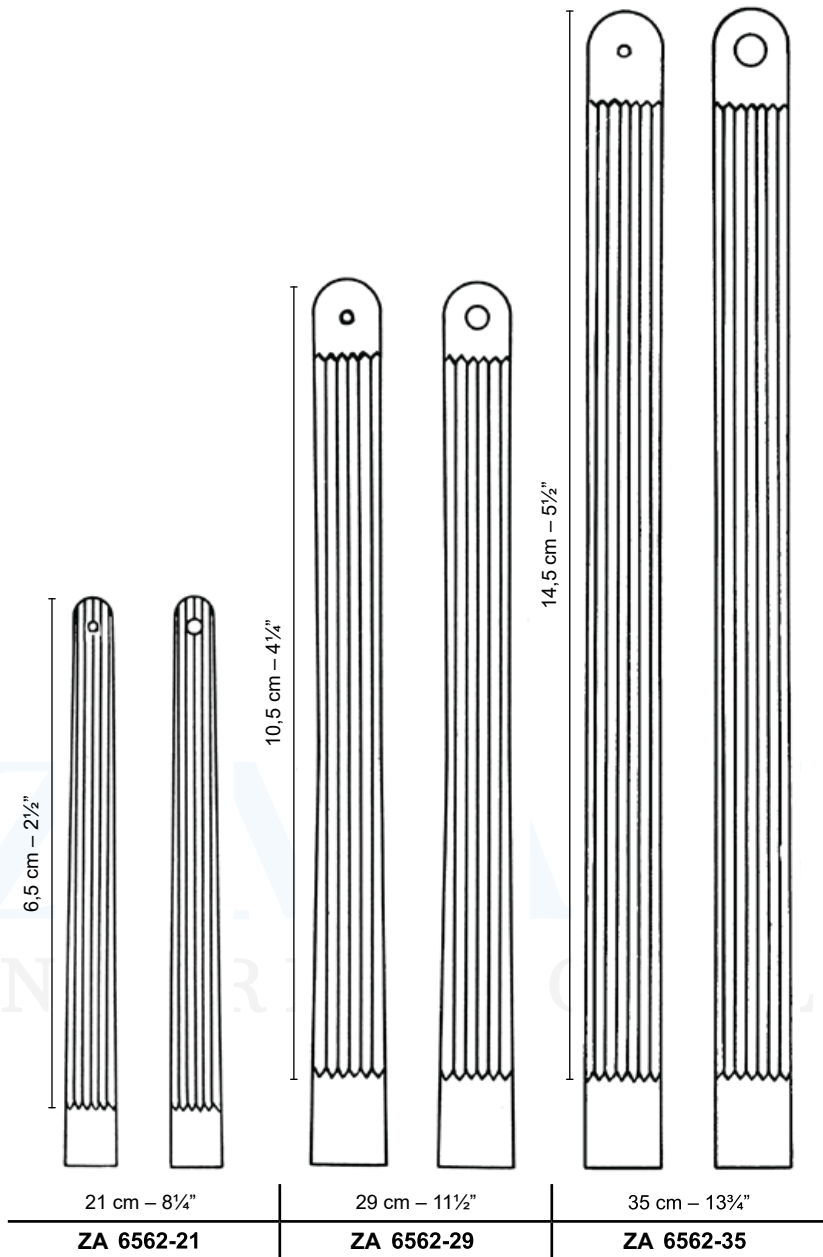



Magen- und Darm-Zwillingsklemmen Stomach and Intestinal Twin Clamps



1:3



1:3

LANE



gerade
straight

30 cm – 11³/₄"

ZA 6570-30

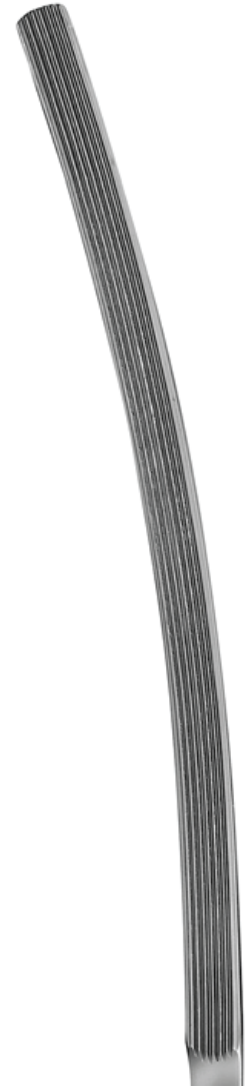

gebogen
curved

30 cm – 11³/₄"

ZA 6571-30

Anastomosenklemmen Anastomosis Clamps



Schließzange
Closing forceps

26 cm – 10¼"
ZA 6580-00

DE MARTEL-WOLFSON



Satz von 3 Klemmen
Set of 3 clamps

5 cm – 2"	7 cm – 2¾"	10 cm – 4"
ZA 6580-05	ZA 6580-07	ZA 6580-10

DE MARTEL-WOLFSON



Klemmenhalter
für MA 6580-05, -07, -10
Clamp holder
for MA 6580-05, -07, -10



8,5 cm – 3¼"	ZA 6580-20
23 cm – 9"	ZA 6580-23

DE MARTEL-WOLFSON



Rektum-Anastomosenklemmen Sigmoid Anastomosis Clamps



RESANO

1:3

30 cm – 11 $\frac{1}{4}$ "
ZA 6544-30



LLOYD-DAVIS

1:3

31,5 cm – 12 $\frac{1}{2}$ "
ZA 6545-31



HAYES

1:3

DE BAKEY Zahnung
DE BAKEY Serration

26 cm – 10 $\frac{1}{4}$ "
ZA 6546-26



DE BAKEY Zahnung
DE BAKEY Serration

28 cm – 11"
ZA 6546-28

Rektum-Anastomosenklemmen Sigmoid Anastomosis Clamps



DE BAKEY Zahnung
DE BAKEY Serration

FEHLAND



24 cm – 9½"

ZA 6547-24



ZIMAIZ
INTERNATIONAL

DE BAKEY Zahnung
DE BAKEY Serration



BRUNNER



24 cm – 9½"

ZA 6548-24

ZA 6549-24



Rektum-Spekula Rectal Specula



CZERNY



PRATT





SIMS

Gesamtlänge Total length	Blattlänge Length of blade	
22 cm – 8¾"	80 x 20 mm	ZA 6595-08
	125 x 20 mm	ZA 6595-12

ZIMAIZ
INTERNATIONAL



MATHIEU

Blattlänge
Length of blade
90 x 15 mm

19,5 cm – 7¾"
ZA 6596-19



BARR

Blattlänge
Length of blade
70 x 22 mm

17 cm – 6¾"
ZA 6597-17



Rektoskope Rectoscopes

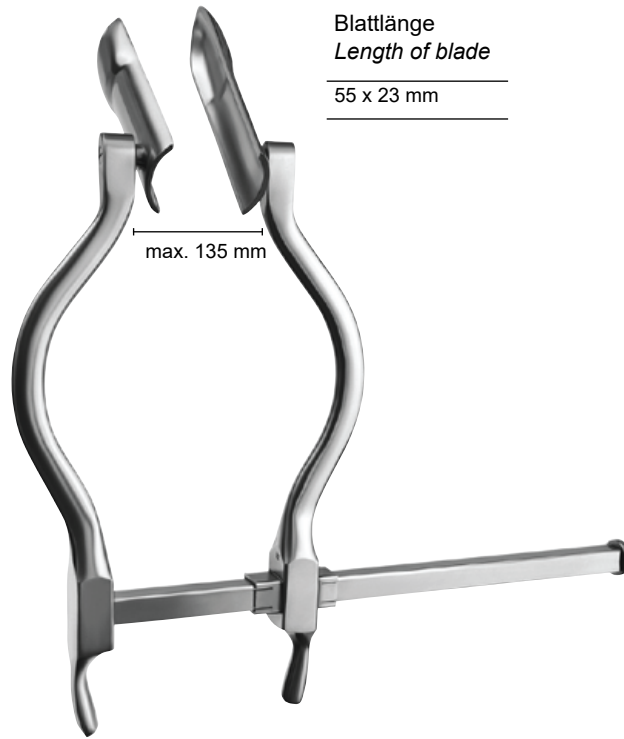

Blattlänge
Length of blade
55 x 23 mm

max. 135 mm

Analspreizer
Anal retractor

15 cm – 6"
ZA 6598-15

SMITH-BUIE



ZIMAIZ
INTERNATIONAL

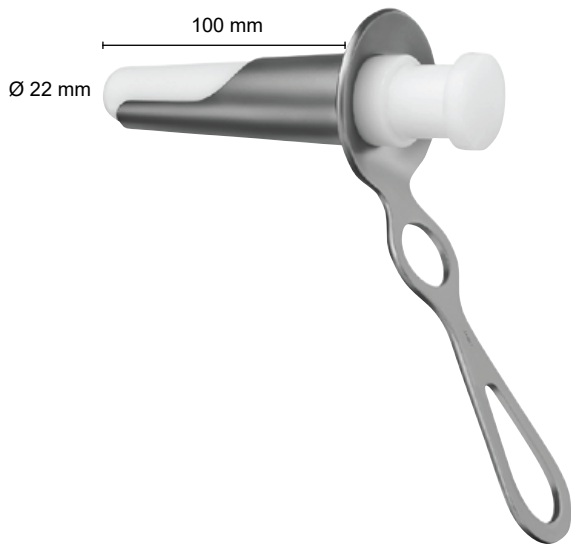

Anoskop
Anoscope

13,5 cm – 5¼"

ZA 6604-00

IVES-FANSLER

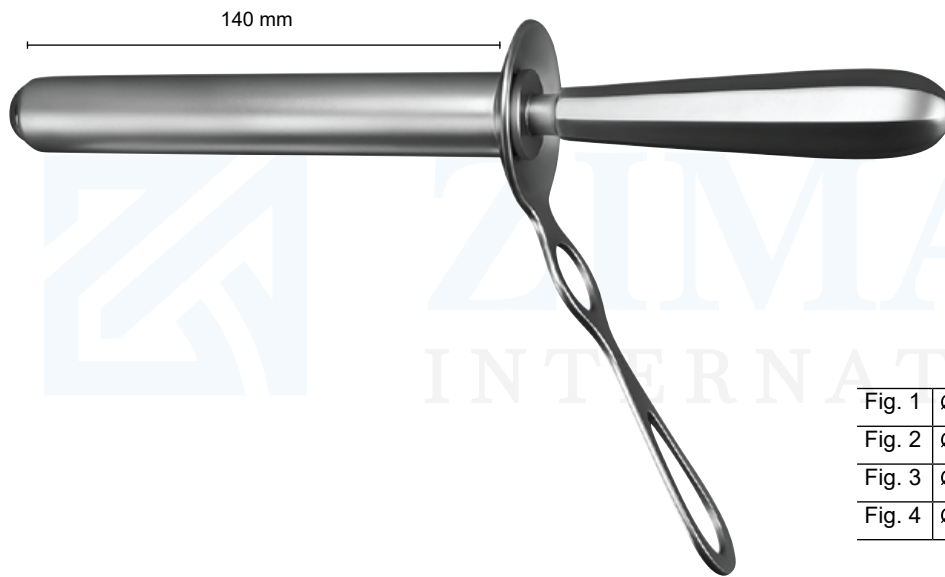

Proktoskope
Proctoscopes

Fig. 1	Ø 22 mm x 50 mm	ZA 6605-01
Fig. 2	Ø 22 mm x 100 mm	ZA 6605-02
Fig. 3	Ø 22 mm x 140 mm	ZA 6605-03
Fig. 4	Ø 22 mm x 200 mm	ZA 6605-04

KELLY



Sphinkteroskope
Sphincteroscopes

	16 cm – 6¼"	
Fig. 1	Ø 21 mm x 50 mm	ZA 6606-01
Fig. 2	Ø 25 mm x 50 mm	ZA 6606-02

KELLY



Analspreizer Rectal Spreader

Maßangaben für Mittelblätter
und Blätter

1. Zahl = Länge
2. Zahl = Breite

*Dimensions for central blades
and blades*

1st number = length

2nd number = width

Mittelblatt

Beispiel: 95 x 22 mm

Central blade

Example: 95 x 22 mm

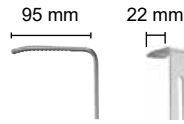

Blätter

Beispiel: 60 x 25 mm

Blades

Example: 60 x 25 mm

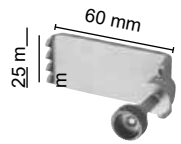

PARK

Sperrer allein <i>Retractor only</i>	ZA 6608-01
---	-------------------

Satz komplett, bestehend aus: <i>Set complete, consisting of:</i>	ZA 6608-00
--	-------------------

Sperrer allein, 14,5 cm – 5¾" (ZA 6608-01) ^{ZA}
Retractor only, 14,5 cm – 5¾" (ZA 6608-01)

1 Mittelblatt 95 x 22 mm (ZA 6608-20)

1 Central blade 95 x 22 mm (ZA 6608-20)

1 Paar Blätter seitlich, 70 x 20 mm (ZA 6608-27)

1 pair of blades lateral, 70 x 20 mm (6608-27)

1 Paar Blätter seitlich, 90 x 20 mm (ZA 6608-29)

1 pair of blades lateral, 90 x 20 mm (6608-29)



1 Paar
1 pair

70 x 20 mm

ZA 6608-27



1 Paar
1 pair

90 x 20 mm

ZA 6608-29



Mittelblatt
Central blade

95 x 22 mm

ZA 6608-20

Rektum-Biopsiefasszangen Rectal Biopsy Forceps

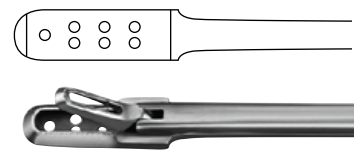
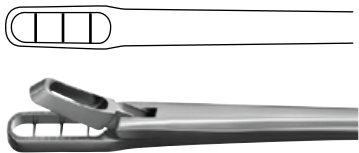
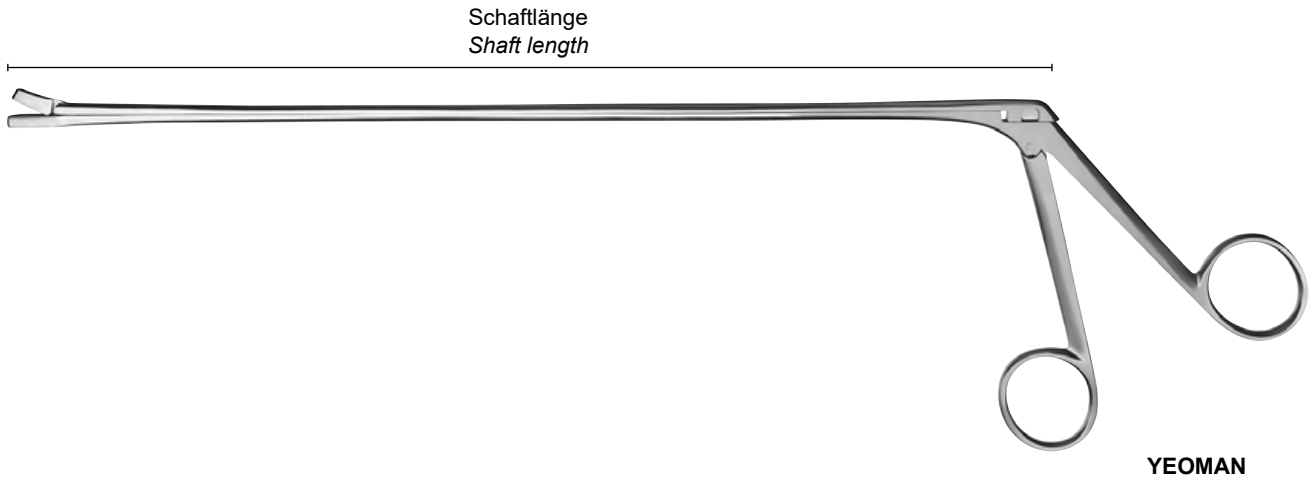

	Bissbreite <i>Bite width</i>	Schaftlänge <i>Shaft length</i>	Fig. 1
	3 mm	28 cm – 11"	ZA 6610-28
		35 cm – 13¾"	ZA 6610-35
		42 cm – 16½"	ZA 6610-42

	Bissbreite <i>Bite width</i>	Schaftlänge <i>Shaft length</i>	Fig. 2
	4 mm	28 cm – 11"	ZA 6611-28
		35 cm – 13¾"	ZA 6611-35
		42 cm – 16½"	ZA 6611-42

ZIMAIZ INTERNATIONAL



Hämorrhoidalzangen Haemorrhoidal Forceps



PRATT



15 cm – 6"

ZA 3150-15



FERGUSSON



gerade
straight



gebogen
curved

16 cm – 6¼"

ZA 3390-16

ZA 3391-16



ZIMAIZ
INTERNATIONAL



HEYWOOD-SMITH



gerade
straight

21 cm – 8¼"

ZA 6616-20



HEYWOOD-SMITH



gerade
straight

21 cm – 8¼"

ZA 6617-21

Hämorrhoidalzangen
Haemorrhoidal Forceps

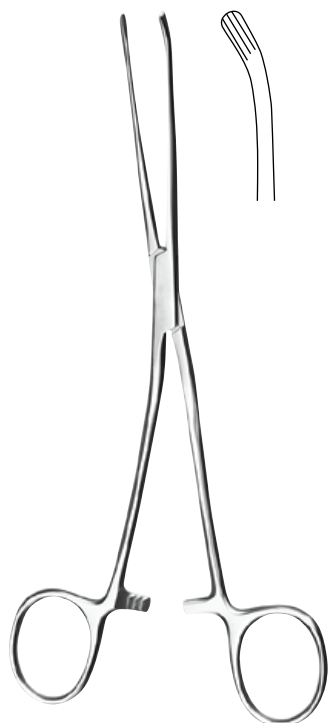

MC GIVNEY

19 cm – 7½"

ZA 6622-19



ZIMAIZ
INTERNATIONAL



Hämorrhoidal-Ligatoren Haemorrhoidal Ligators



Hämorrhoidal-Ligator komplett, bestehend aus: <i>Haemorrhoidal ligator complete, consisting of:</i>	ZA 6620-00
--	-------------------

- 1 Hämorrhoidal-Ligator (ZA 6620-01) ZA
- 1 Haemorrhoidal ligator (ZA 6620-01)
- 1 Ladekonus Ø 10 mm (ZA 6620-10)
- 1 Charging cone Ø 10 mm (ZA 6620-10)
- 1 Saugkopf 11 mm x Ø 10 mm (ZA 6620-11)
- 1 Aspiration tip 11 mm x Ø 10 mm (ZA 6620-11)
- 1 Saugkopf 16 mm x Ø 10 mm (ZA 6620-16)
- 1 Aspiration tip 16 mm x Ø 10 mm (ZA 6620-16)
- 1 Ligatur-Gummiringe (100 Stück) (ZA 6620-51)
- 1 Ligature rubber rings (100 pieces) (ZA 6620-51)



Ø 10 mm

Ladekonus
Charging cone

ZA 6620-10

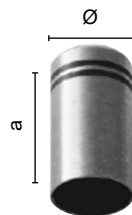

a	Ø	Saugkopf Aspiration tip
11 mm	10 mm	ZA 6620-11
16 mm	10 mm	ZA 6620-16



Ligatur-Gummiringe, **latexfrei**,
Verpackungseinheit 100 Stück

*Ligature rubber rings, latex free,
packing unit 100 pieces*

ZA 6620-51

Hämorrhoidal-Ligatoren Haemorrhoidal Ligators



Ø 12 mm

Ladekonus
Charging cone

ZA 6621-12

Hämorrhoidal-Ligator komplett, bestehend aus: <i>Haemorrhoidal ligator complete, consisting of:</i>	ZA 6621-00
--	-------------------

- 1 x Hämorrhoidal-Ligator, 31,5 cm – 12½" (ZA 6621-01)
- 1 x *Haemorrhoidal ligator*, 31,5 cm – 12½" (ZA 6621-01)
- 1 x Ladekonus Ø 12 mm (ZA 6621-12)
- 1 x *Charging cone* Ø 12 mm (ZA 6621-12)
- 1 x Ligatur-Gummiringe (100 Stück) (ZA 6620-51)
- 1 x *Ligature rubber rings* (100 pieces) (ZA 6620-51)



Ligatur-Gummiringe, **latexfrei**,
Verpackungseinheit 100 Stück

Ligature rubber rings, latex free,
packing unit 100 pieces

ZA 6620-51

Hämorrhoidal-Ligator komplett, bestehend aus: <i>Haemorrhoidal ligator complete, consisting of:</i>	ZA 6622-00
--	-------------------

- 1 x Hämorrhoidal-Ligator
- 1 x *Haemorrhoidal ligator*
- 1 x Ladekonus Ø 13 mm (ZA 6622-21)
- 1 x *Charging cone* Ø 13 mm (ZA 6622-21)



4 cm – 1½"

Ladekonus, Ø 13 mm
Charging cone, Ø 13 mm

ZA 6622-21

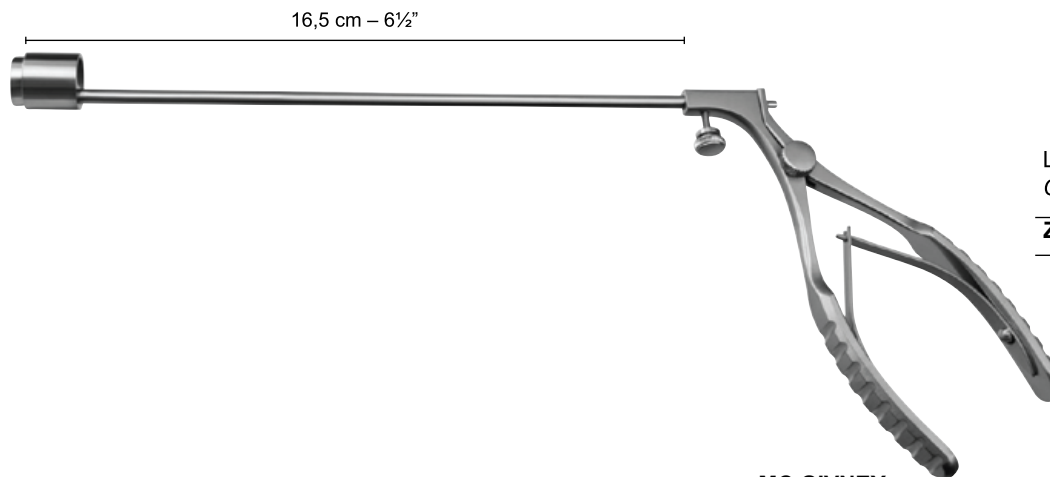



Hämorrhoidal-Ligatoren Haemorrhoidal Ligators

Hämorrhoidal-Ligatur komplett, bestehend aus: <i>Haemorrhoidal ligator complete, consisting of:</i>	ZA 6622-05
1 x Hämorrhoidal-Ligatur <i>1 x Haemorrhoidal ligator</i>	
1 x Ladekonus Ø 13 mm (ZA 6622-21) <i>1 x Charging cone Ø 13 mm (ZA 6622-21)</i>	

latexfrei,

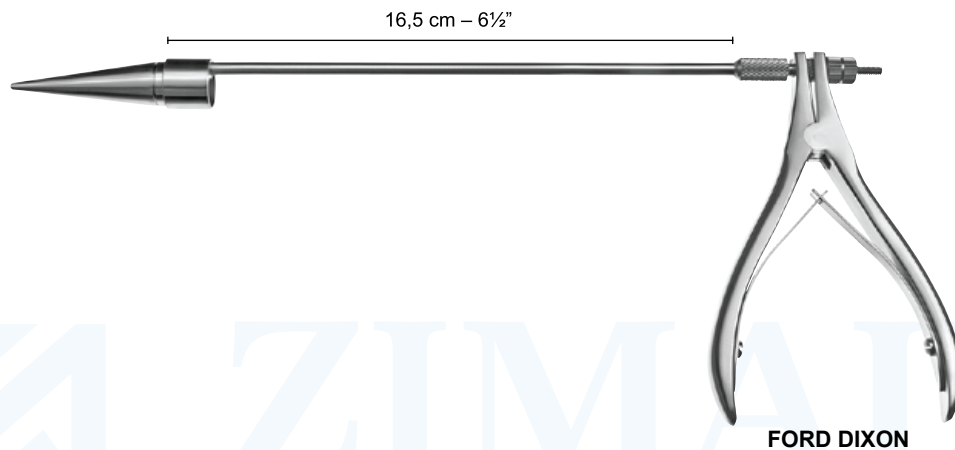

Ladekonus, Ø 13 mm
Charging cone, Ø 13 mm

ZA 6622-21



Ligatur-Gummiringe,
Verpackungseinheit 100 Stück

*Ligature rubber rings, latex free,
packing unit 100 pieces*

ZA 6620-51

Gallenkanal-Klemmzangen
Gall Duct Forceps



GRAY

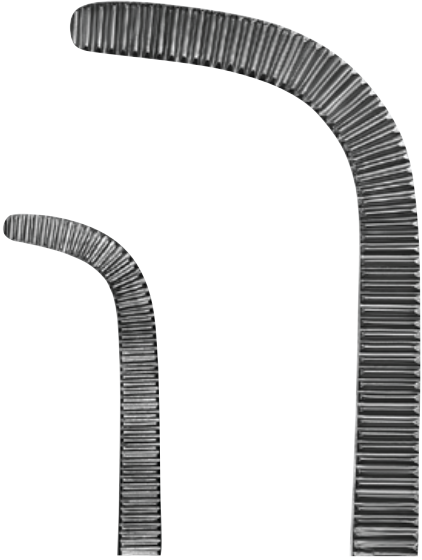
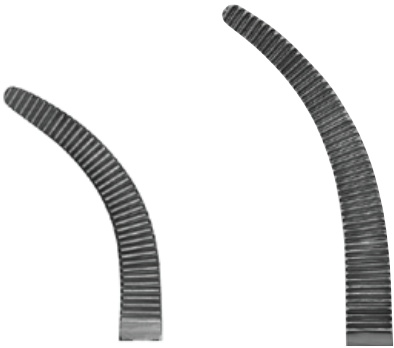

Fig. 1	Fig. 2
22 cm – 8¾"	23 cm – 9"
ZA 6642-01	ZA 6642-02

Satz à Fig. 1 und Fig. 2
Set of fig. 1 and fig. 2

ZA 6642-00



23 cm – 9"	24 cm – 9½"
ZA 3401-23	ZA 3401-24





Gallenkanal-Klemmzangen Gall Duct Forceps

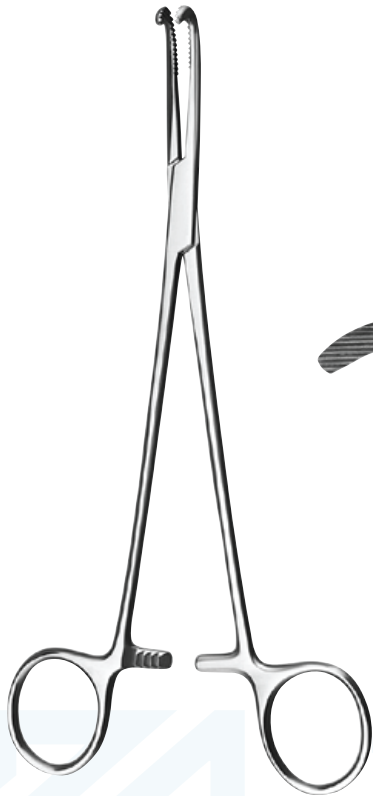

DESJARDINS



gebogen
curved

21 cm – 8¼"

ZA 6644-21



DESJARDINS

Gallensteinzange
Gall stone forceps



gebogen
curved

23 cm – 9"

Fig. 1

Fig. 2

ZA 6657-23

ZA 6658-23

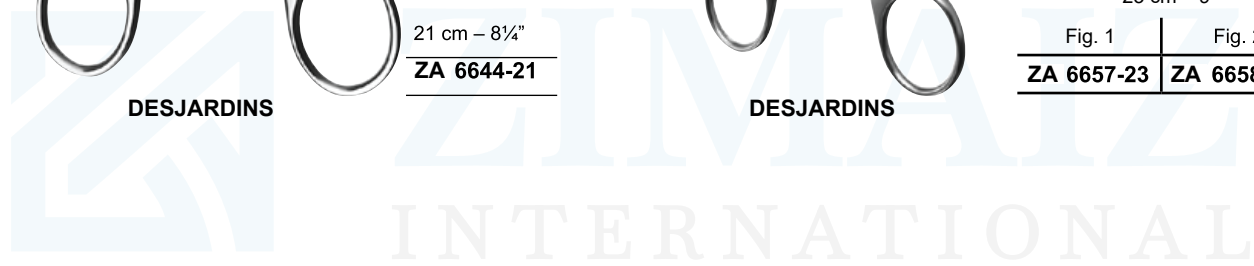



BAKES

Gallengangdilatoren,
biegsam

*Gall duct dilators,
malleable*

mm	30 cm – 11¾"
1	ZA 6665-01
2	ZA 6665-02
3	ZA 6665-03
4	ZA 6665-04
5	ZA 6665-05
6	ZA 6665-06
7	ZA 6665-07
8	ZA 6665-08
9	ZA 6665-09
10	ZA 6665-10
11	ZA 6665-11
12	ZA 6665-12
13	ZA 6665-13

Satz à 9 Stück
ZA 6665-03 – ZA 6665-11

*Set of 9 pieces
ZA 6665-03 – ZA 6665-11*

ZA 6665-00

Satz à 9 Stück
ZA 6665-03 – ZA 6665-11
in Leinentuchtasche

*Set of 9 pieces
ZA 6665-03 – ZA 6665-11
in canvas pocket*

ZA 6665-50

Leinentuchtasche, allein
Canvas pocket, only

ZA 6665-71



*federnd
elastic*

DESJARDINS

30 cm – 12"



Fig. 1

ZA 6670-01



Fig. 2

ZA 6670-02



Fig. 3

ZA 6670-03



Fig. 4

ZA 6670-04



Gallenkanal Instrumente Gall Duct Instruments



biegsam
malleable

LUER-KOERTE
32 cm – 12½"



2,5 mm

ZA 6675-02



3,2 mm

ZA 6675-03



4,2 mm

ZA 6675-04



5,5 mm

ZA 6675-05



6,7 mm

ZA 6675-06



8 mm

ZA 6675-08



11 mm

ZA 6675-11



15 mm

ZA 6675-15

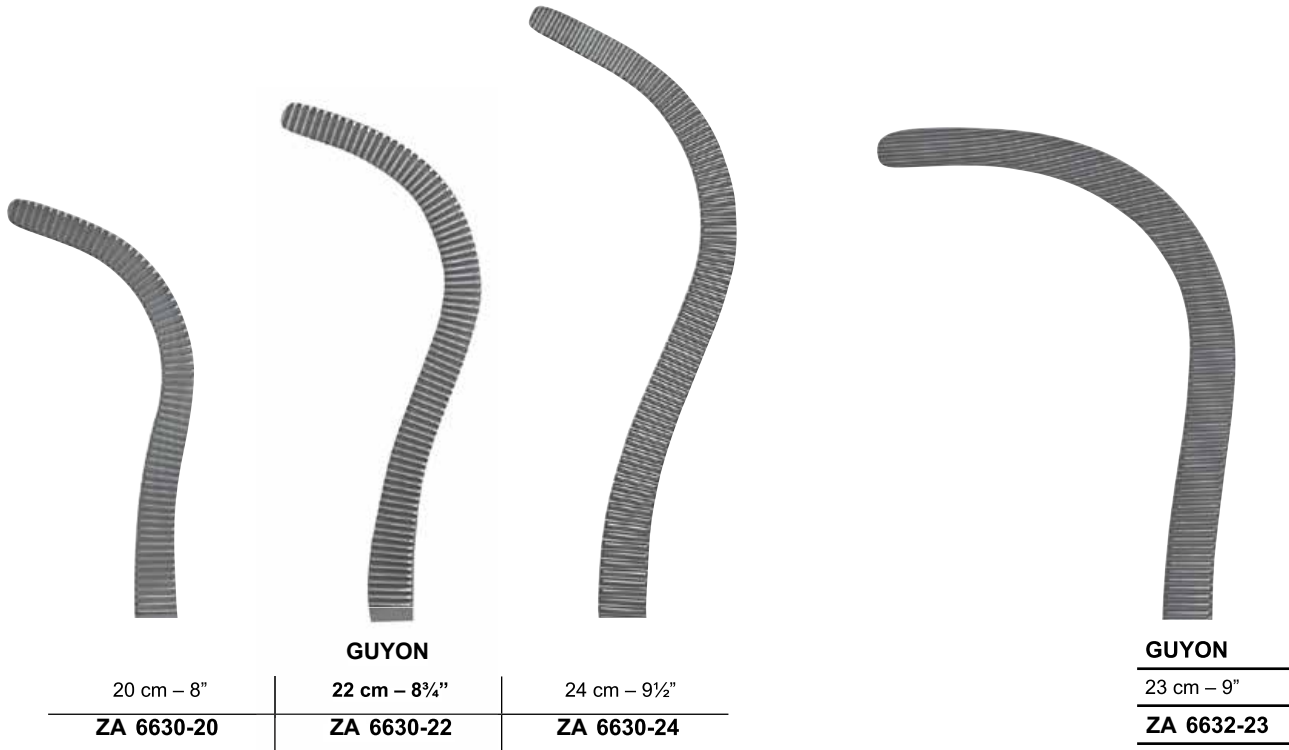

DE BAKEY Zahnung
DE BAKEY Serration

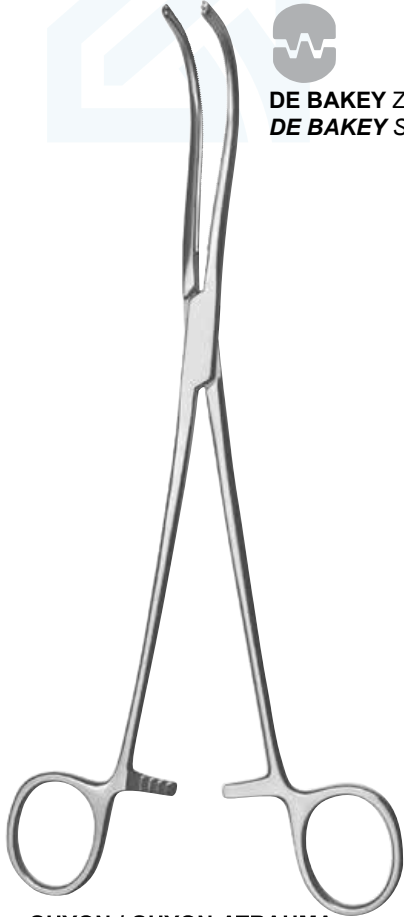

GUYON / GUYON-ATRAUMA





Nierensteinzangen Kidney Stone Forceps

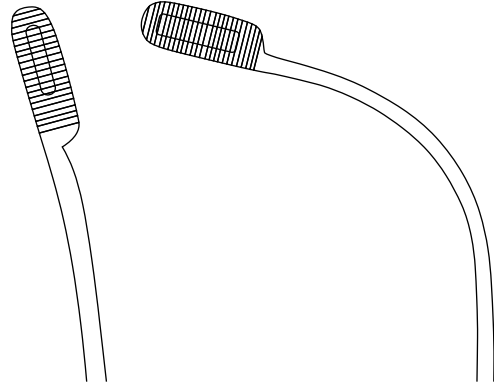

gebogen
curved

Fig. 1

24 cm – 9½"

ZA 6640-01

Fig. 2

21 cm – 8¼"

ZA 6640-02



RANDALL

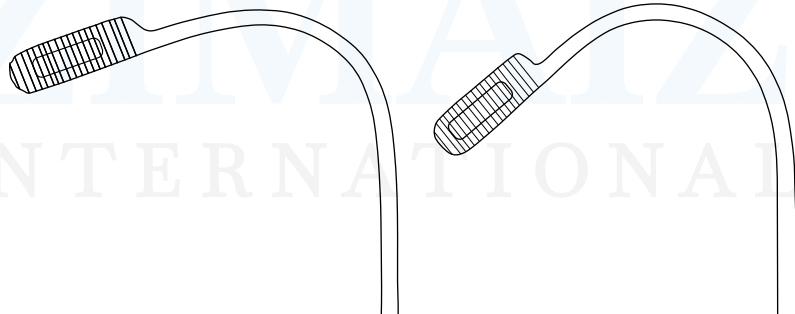

gebogen
curved

Fig. 3

20 cm – 8"

ZA 6640-03

Fig. 4

20 cm – 8"

ZA 6640-04

Blasenwundspreizer Bladder Retractors



Maßangaben für Mittelblätter
und Blätter

1. Zahl = Länge
2. Zahl = Breite

*Dimensions for central blades
and blades*

1st number = length

2nd number = width

Mittelblatt

Beispiel: 95 x 22 mm

Central blade

Example: 95 x 22 mm

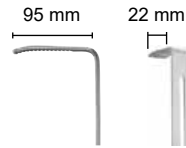

Blätter

Beispiel: 60 x 25 mm

Blades

Example: 60 x 25 mm

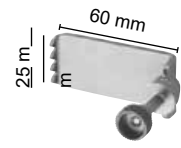

Blasenwundspreizer komplett, bestehend aus: <i>Bladder retractor complete, consisting of:</i>	ZA 6702-00
Sperrer allein <i>Retractor only</i>	
1 Paar Blätter 57 x 25 mm <i>1 pair of blades 57 x 25 mm</i>	
1 Paar Blätter 80 x 25 mm (max. Spreizweite 120 mm) <i>1 pair of blades, 80 x 25 mm (max. spread 120 mm)</i>	
1 Mittelblatt, 110 x 45 mm <i>1 Central blade, 110 x 45 mm</i>	





Blasenwundspreizer Bladder Retractors

Maßangaben für Mittelblätter
und Blätter

1. Zahl = Länge
2. Zahl = Breite

*Dimensions for central blades
and blades*

1st number = length

2nd number = width

Mittelblatt

Beispiel: 95 x 22 mm

Central blade

Example: 95 x 22 mm

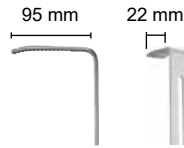

Blätter

Beispiel: 60 x 25 mm

Blades

Example: 60 x 25 mm

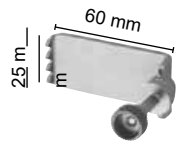

LEGUEU

Blasenwundspreizer komplett, bestehend aus:
Bladder retractor complete, consisting of:

ZA 6703-00

Sperrer allein
Retractor only

1 Paar Blätter 62 x 30 mm (max. Spreizweite 70 mm)

1 pair of blades 62 x 30 mm (max. spread 70 mm)

1 Mittelblatt, 85 x 31 mm

1 Central blade, 85 x 31 mm

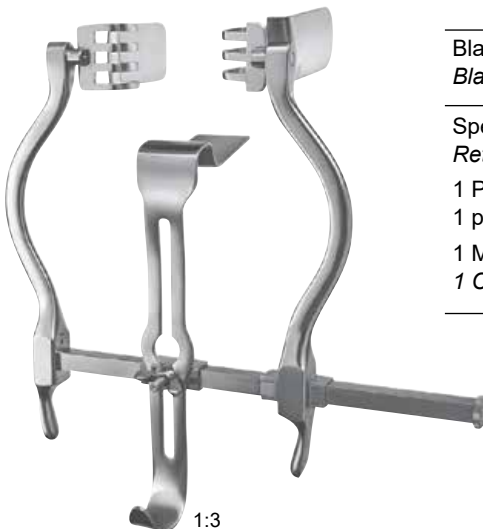

1:3

JUDD-MASSON

Blasenwundspreizer komplett, bestehend aus:
Bladder retractor complete, consisting of:

ZA 6706-00

Sperrer allein
Retractor only

1 Paar Blätter 67 x 25 mm (max. Spreizweite 120 mm)

1 pair of blades 67 x 25 mm (max. spread 120 mm)

1 Mittelblatt, 75 x 25 mm

1 Central blade, 75 x 25 mm

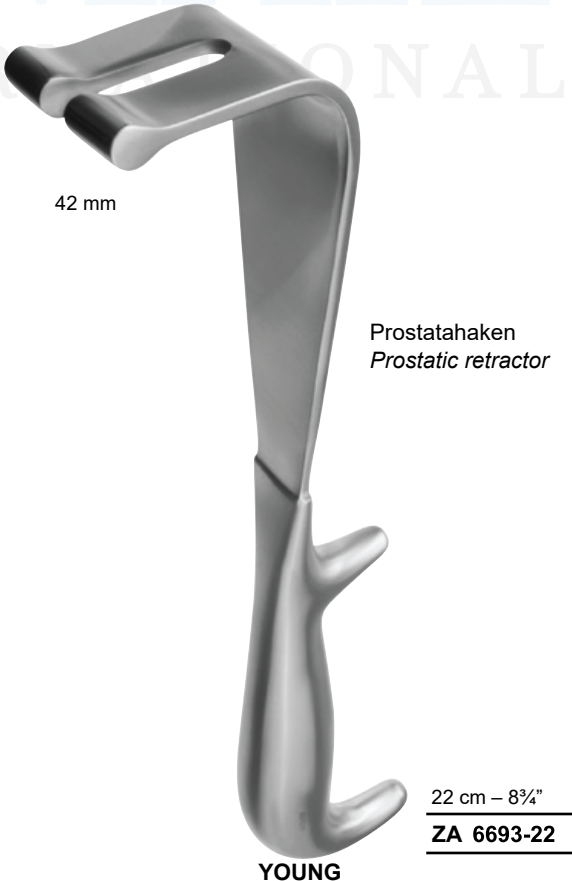
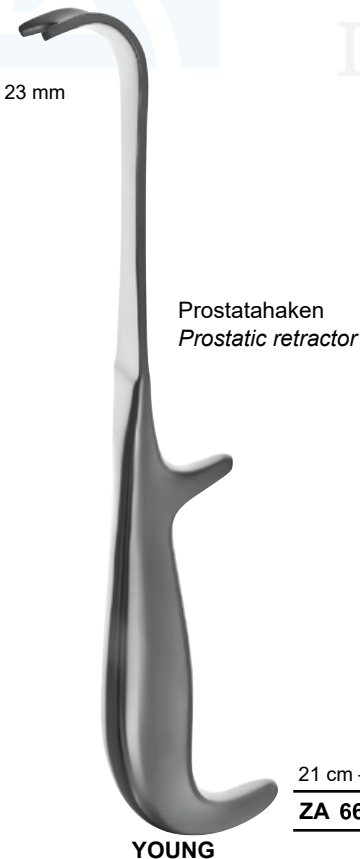



Urologie-Instrumente Urology Instruments

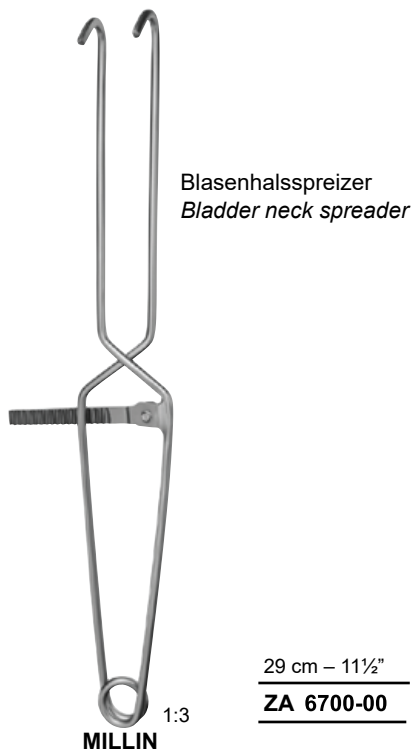



1:3

VAN BURREN

Urethrale Bougies, gebogen
Urethral bougies, curved

Fr. / Charr.	Ø mm	Bèniqùè	27 cm – 10½"
8	2⅔	–	ZA 6710-08
10	3⅓	20	ZA 6710-10
12	4	24	ZA 6710-12
14	4⅔	28	ZA 6710-14
16	5⅓	32	ZA 6710-16
18	6	36	ZA 6710-18
20	6⅔	40	ZA 6710-20
22	7⅓	44	ZA 6710-22
24	8	48	ZA 6710-24
26	8⅔	52	ZA 6710-26
28	9⅓	56	ZA 6710-28
30	10	60	ZA 6710-30
32	10⅓	–	ZA 6710-32
34	10⅔	–	ZA 6710-34
36	12	–	ZA 6710-36

Satz à 6 Stück Fr. / Charr. 14-24
in Segeltuchtasche

Set of 6 pieces Fr. / Charr. 14-24
in canvas pocket

ZA 6710-51

Satz à 12 Stück Fr. / Charr. 8-24
in Segeltuchtasche

Set of 12 pieces Fr. / Charr. 8-24
in canvas pocket

ZA 6710-61



ZIMAIZ
INTERNATIONAL



1:3

Metallkatheter für Männer,
gebogen
*Metal catheters for men,
curved*

Fr. / Charr.	Ø mm	29 cm – 11½"
8	2⅔	ZA 6715-08
10	3⅓	ZA 6715-10
12	4	ZA 6715-12
14	4⅔	ZA 6715-14



Metallkatheter für Frauen,
gebogen
*Metal catheters for women,
curved*

Fr. / Charr.	Ø mm	16 cm – 6¼"
8	3⅓	ZA 6716-08
10	3⅓	ZA 6716-10
12	4	ZA 6716-12
14	4⅔	ZA 6716-14
16	5⅓	ZA 6716-16
18	6	ZA 6716-18



Urologie-Instrumente Urology Instruments

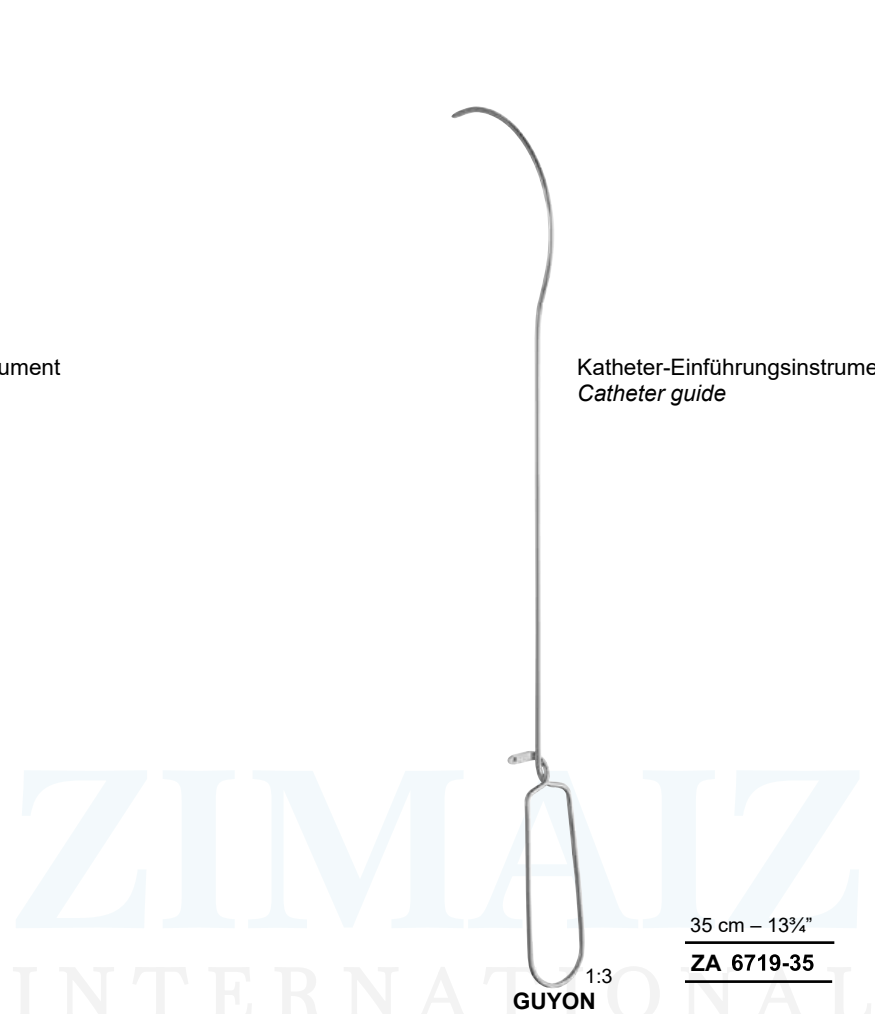
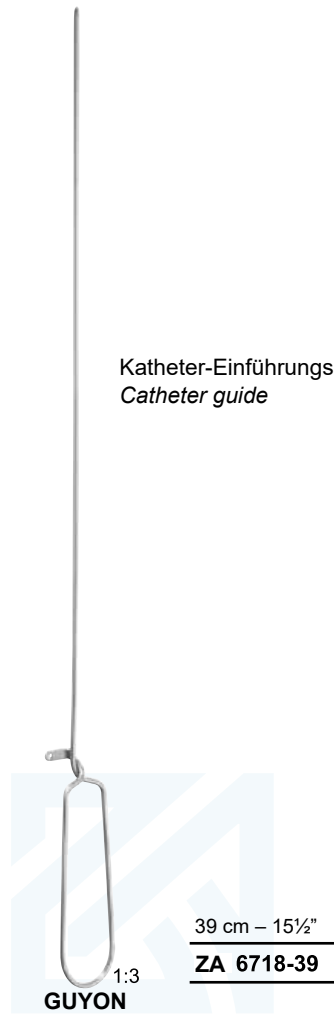

Beschneidungsinstrument
Circumcision instrument

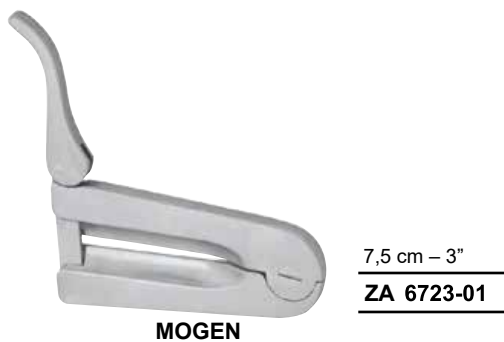

Beschneidungsinstrument
Circumcision instrument



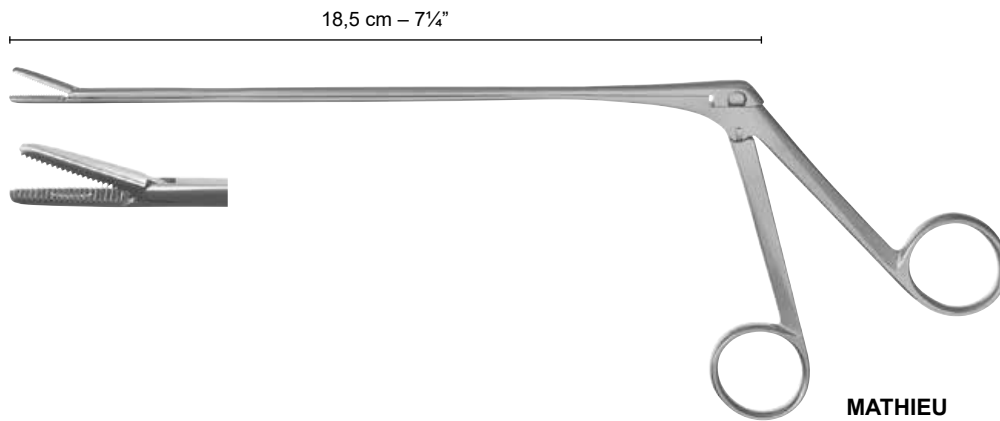

Fremdkörperzange *Foreign body forceps*

ZA 6727-20

MATHIEU



Penisklemme
Penis clamp

7 cm - 2 3/4\"/>

ZA 6730-00

STOCKMANN



Sekretlöffel, biegsam
Secretion spoon, malleable

26,5 cm - 10 1/2\"/>

ZA 6735-26

GUTTMANN



Penisklemme
Penis clamp

13 cm - 5\"/>

ZA 6732-00

STRAUSS



ZIMAIZ
INTERNATIONAL