



ZIMAIZ
INTERNATIONAL



Gynecology

SURGICAL
INSTRUMENTS
CATALOGUE





Gynäkologie und Geburtshilfe Gynecology and Obstetrics

Scheidenspekula	<i>Vaginal Specula</i>	GO 1 - 18, 20 - 21
Scheidenhalter	<i>Vaginal Retractors</i>	GO 19
Uterusdilatoren	<i>Uterine Dilators</i>	GO 22
Endospekula für Cervix	<i>Endospecula for Cervix</i>	GO 23
Uterussonden	<i>Uterine Probes</i>	GO 24
Fasszangen	<i>Grasping Forceps</i>	GO 25
Hakenzangen	<i>Uterine Tenaculum Forceps</i>	GO 26 - 32
Polypen- und Ovarienzangen	<i>Polypus- and Ovary Forceps</i>	GO 33 - 34
Uterusfasszangen	<i>Uterine Elevating Forceps</i>	GO 36 - 37
Biopsieinstrumente	<i>Biopsy Instruments</i>	GO 37, 44
Parametriumklemmen	<i>Parametrium Forceps</i>	GO 38 - 40
Hysterektomieklemmen	<i>Hysterectomy Forceps</i>	GO 41 - 42
Vaginalklemmen	<i>Vaginal Forceps</i>	GO 43
Biopsie Küretten	<i>Biopsy Curettes</i>	GO 45
Biopsie Zangen	<i>Biopsy Forceps</i>	GO 46 - 51
Uterus Biopsie Zangen	<i>Uterine Biopsy Forceps</i>	GO 52 - 56
Uteruslöffel	<i>Uterine Scoops</i>	GO 54
Uterusküretten	<i>Uterine Curettes</i>	GO 55 - 57
Biopsie- und Absaugküretten	<i>Biopsy and Aspirating Curettes</i>	GO 58
Salpingograph	<i>Salpingograph</i>	GO 59 - 60
Geburtshilfe	<i>Obstetrics</i>	GO 61 - 62
Geburtszangen	<i>Obstetrical Forceps</i>	GO 63 - 65
Abortuszangen	<i>Ovum Forceps</i>	GO 66
Abortus- und Plazentazangen	<i>Ovum and Placenta Forceps</i>	GO 67
Uterusklemmzangen	<i>Uterine Forceps</i>	GO 68

Scheidenspekula Vaginal Specula



Maßschema für Spekulum
Scheme of dimensions for specula

a	Blattlänge Length of blade
b	Blattbreite Width of blade

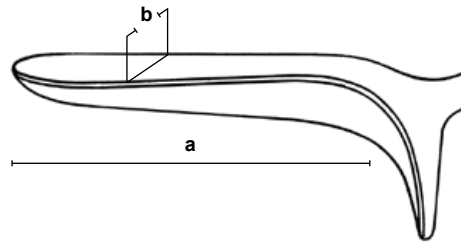

a mm	b mm	für Kinderfor children
65	10	ZA 7020-10

ZIMAIZ
INTERNATIONAL

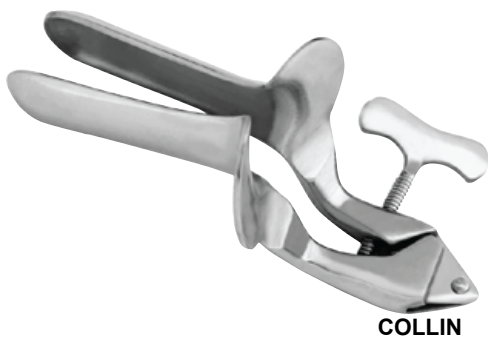

a mm	b mm	für Jungfrauen virgins for
65	20	ZA 7020-11
85	30	ZA 7020-01
100	35	ZA 7020-02
110	40	ZA 7020-03



Scheidenspekula Vaginal Specula

Maßschema für Spekulum
Scheme of dimensions for specula

a	Blattlänge Length of blade
b	Blattbreite Width of blade

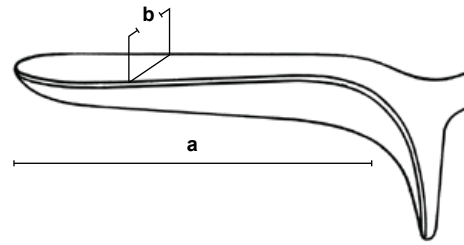

a mm	b mm	für Jungfrauen for virgins
75	17	ZA 7002-00

CUSCO

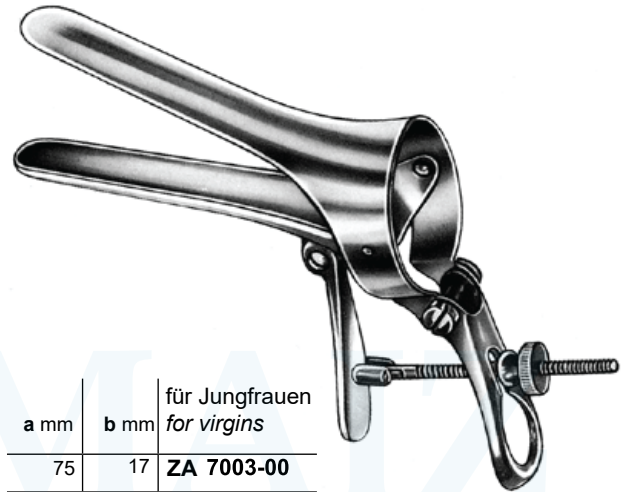

a mm	b mm	für Jungfrauen for virgins
75	17	ZA 7003-00

CUSCO

lang und schmal
long and narrow



CUSCO

a mm	b mm	Schweizer Modell Swiss pattern
90	23-25	ZA 7004-01
100	25-27	ZA 7004-02
110	27-30	ZA 7004-03

Scheidenspekula Vaginal Specula



Maßschema für Spekulum
Scheme of dimensions for specula

a	Blattlänge Length of blade
b	Blattbreite Width of blade

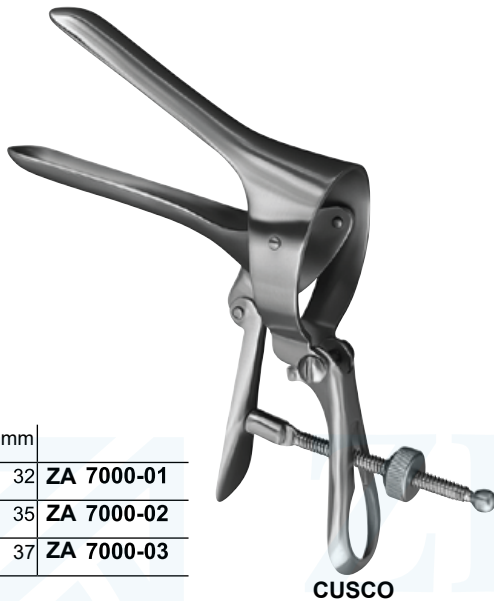
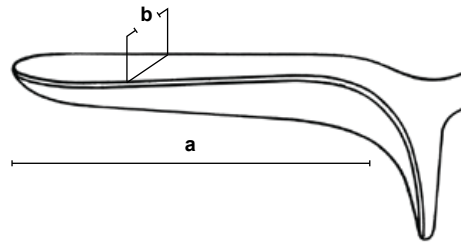

a mm	b mm	
75	32	ZA 7000-01
85	35	ZA 7000-02
100	37	ZA 7000-03

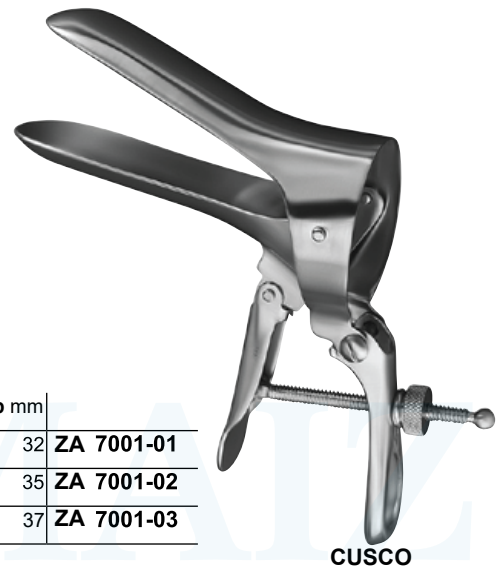

a mm	b mm	
75	32	ZA 7001-01
85	35	ZA 7001-02
100	37	ZA 7001-03

INTERNATIONAL



Scheidenspekula Vaginal Specula

Maßschema für Spekulum
Scheme of dimensions for specula

a	Blattlänge Length of blade
b	Blattbreite Width of blade

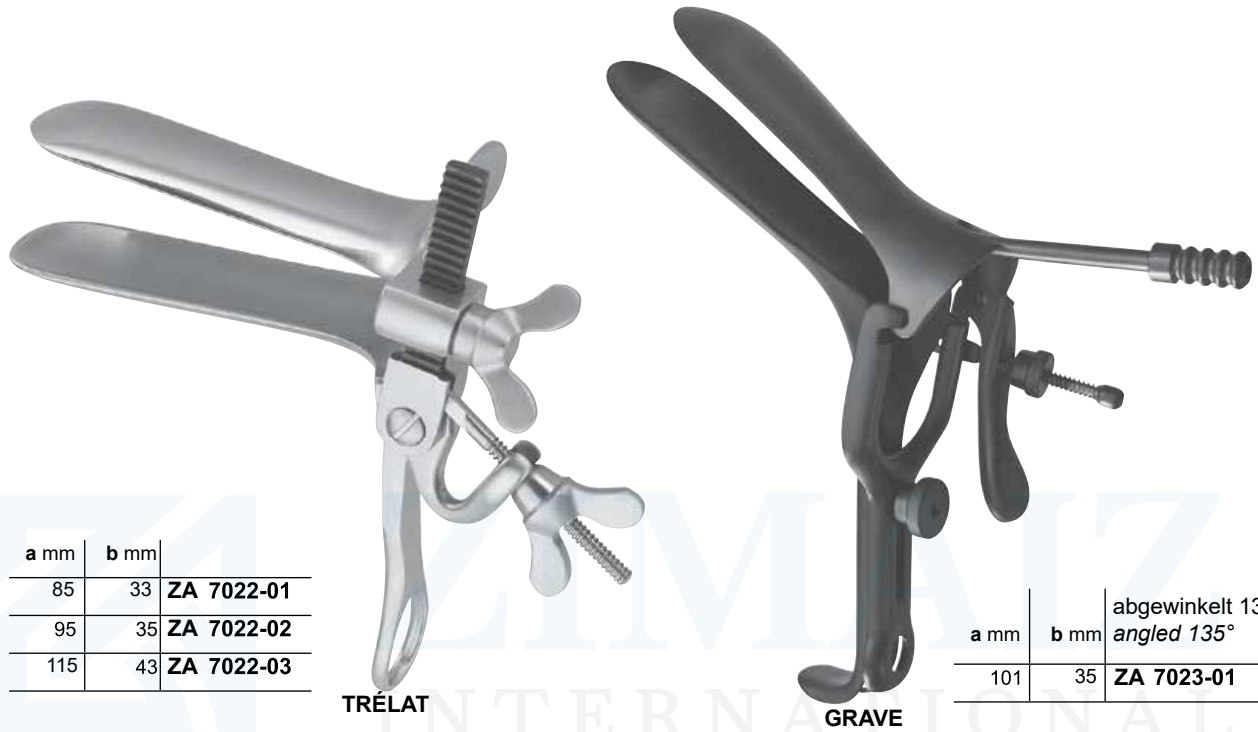
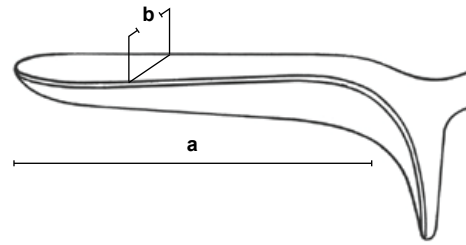

a mm	b mm	
85	33	ZA 7022-01
95	35	ZA 7022-02
115	43	ZA 7022-03

a mm	b mm	abgewinkelt 135° angled 135°
101	35	ZA 7023-01

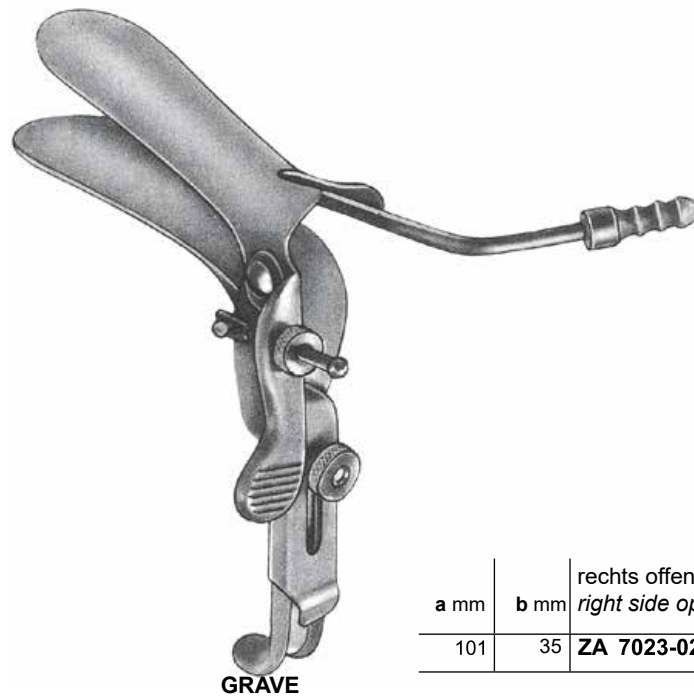

a mm	b mm	rechts offen, abgewinkelt 90° right side open, angled 90°	rechts offen, abgewinkelt 135° right side open, angled 135°
101	35	ZA 7023-02	ZA 7023-03

Scheidenspekula Vaginal Specula



Maßschema für Spekulum
Scheme of dimensions for specula

a	Blattlänge Length of blade
b	Blattbreite Width of blade

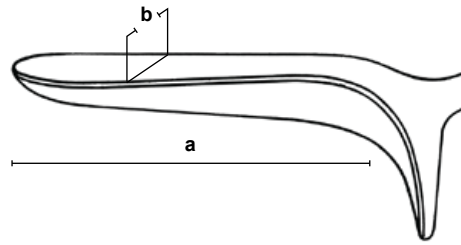

Laser-Spekula
Laser specula



a mm	b mm	
75	20	ZA 7024-01
95	30	ZA 7024-02
115	35	ZA 7024-03

GRAVE

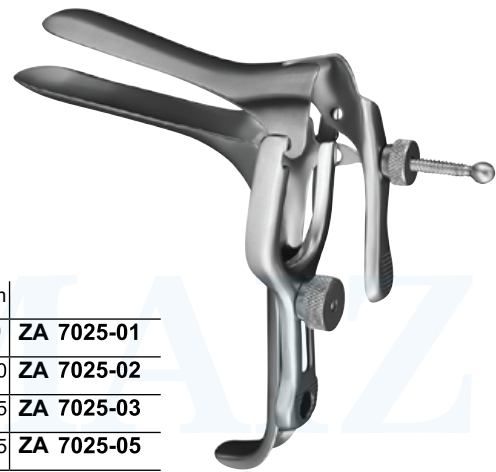

a mm	b mm	
75	20	ZA 7025-01
95	30	ZA 7025-02
115	35	ZA 7025-03
125	35	ZA 7025-05

GRAVE

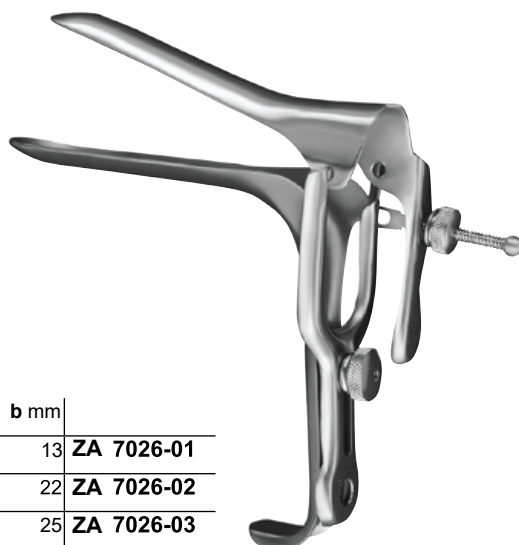

a mm	b mm	
75	13	ZA 7026-01
100	22	ZA 7026-02
120	25	ZA 7026-03

PENDERSON

55 mm
56 x 21 mm



Lateral-Spekulum
Lateral specula

1:3

25,5 cm – 10"
ZA 7040-00



Scheidenspekula, Sets Vaginal Specula, Sets

Maßschema für Spekulum
Scheme of dimensions for specula

a	Blattlänge Length of blade
b	Blattbreite Width of blade

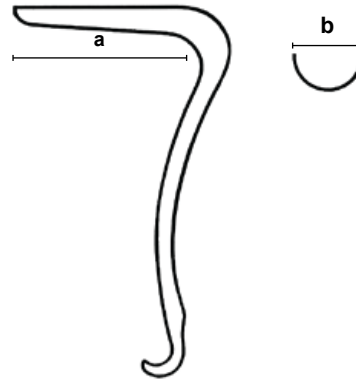

SIMS

a mm	b mm	
53	32	ZA 7049-01
58	32	ZA 7049-02
70	38	ZA 7049-03



Fig.	a mm	b mm	
1	60	25 + 30	ZA 7050-01
2	70	30 + 35	ZA 7050-02
3	80	35 + 40	ZA 7050-03

Satz
Set
ZA 7050-00

Scheidenspekula, Sets Vaginal Specula, Sets



Maßschema für Spekulum
Scheme of dimensions for specula

a	Blattlänge Length of blade
b	Blattbreite Width of blade

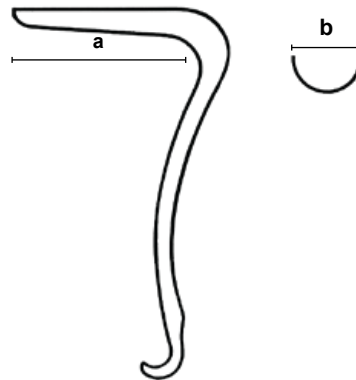

Fig.	a mm	b mm	
1	75	35	ZA 7055-01
2	90	35	ZA 7055-02
3	100	35	ZA 7055-03

Fig.	a mm	b mm	
1	75	38	ZA 7056-01
2	90	38	ZA 7056-02
3	100	38	ZA 7056-03



Scheidenspekulum komplett, bestehend aus: <i>Vaginal specula complete, consisting of:</i>	ZA 7078-01
--	-------------------

- 1 Spekulum Fig. 1, 70 x 40 mm (ZA 7078-11)
- 1 Specula fig. 1, 70 x 40 mm (ZA 7078-11)
- 1 Halter Fig. 1, 70 x 33 mm (ZA 7078-21)
- 1 Retractor fig. 1, 70 x 33 mm (ZA 7078-21)

Scheidenspekulum komplett, bestehend aus: <i>Vaginal specula complete, consisting of:</i>	ZA 7078-02
--	-------------------

- 1 Spekulum Fig. 2, 90 x 40 mm (ZA 7078-12)
- 1 Specula fig. 2, 90 x 40 mm (ZA 7078-12)
- 1 Halter Fig. 2, 90 x 33 mm (ZA 7078-22)
- 1 Retractor fig. 2, 90 x 33 mm (ZA 7078-22)

Fig.	a mm	b mm	Spekulum Specula
1	70	40	ZA 7078-11
2	90	40	ZA 7078-12

Fig.	a mm	b mm	Halter Retractor
1	70	33	ZA 7078-21
2	90	33	ZA 7078-22



Scheidenspekula, Sets Vaginal Specula, Sets

Maßschema für Spekulum
Scheme of dimensions for specula

a	Blattlänge Length of blade
b	Blattbreite Width of blade

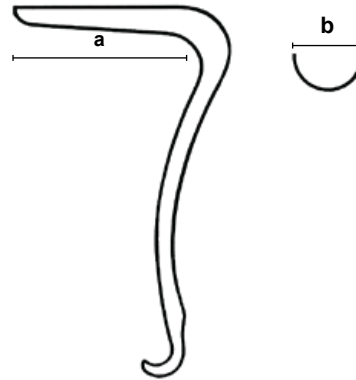

KRISTELLER

ZIMAIZ
INTERNATIONAL

Scheidenspekulum für Kinder komplett, bestehend aus: Vaginal specula for children complete, consisting of:	ZA 7060-00
1 Spekulum, 70 x 15 mm (ZA 7060-30)	
1 Specula, 70 x 15 mm (ZA 7060-30)	
1 Halter, 75 x 10 mm (ZA 7060-40)	
1 Retractor, 75 x 10 mm (ZA 7060-40)	

a mm	b mm	Spekulum Specula
70	15	ZA 7060-30

a mm	b mm	Halter Retractor
75	10	ZA 7060-40

Scheidenspekula, Sets Vaginal Specula, Sets



Maßschema für Spekulum
Scheme of dimensions for specula

a	Blattlänge Length of blade
b	Blattbreite Width of blade

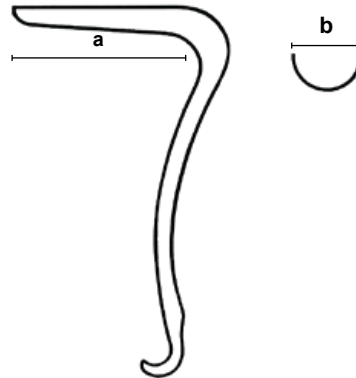

KRISTELLER

Scheidenspekulum komplett, bestehend aus: Vaginal specula complete, consisting of:	ZA 7060-01
1 Spekulum Fig. 1, 70 x 27 mm (ZA 7060-11) 1 Specula fig. 1, 70 x 27 mm (ZA 7060-11) 1 Halter Fig. 1, 75 x 23 mm (ZA 7060-21) 1 Retractor fig. 1, 75 x 23 mm (ZA 7060-21)	

Scheidenspekulum komplett, bestehend aus: Vaginal specula complete, consisting of:	ZA 7060-02
1 Spekulum Fig. 2, 75 x 30 mm (ZA 7060-12) 1 Specula fig. 2, 75 x 30 mm (ZA 7060-12) 1 Halter Fig. 2, 80 x 26 mm (ZA 7060-22) 1 Retractor fig. 2, 80 x 26 mm (ZA 7060-22)	

Scheidenspekulum komplett, bestehend aus: Vaginal specula complete, consisting of:	ZA 7060-03
1 Spekulum Fig. 3, 90 x 36 mm (ZA 7060-13) 1 Specula fig. 3, 90 x 36 mm (ZA 7060-13) 1 Halter Fig. 3, 95 x 32 mm (ZA 7060-23) 1 Retractor fig. 3, 95 x 32 mm (ZA 7060-23)	

Fig.	a mm	b mm	Spekulum Specula	Fig.	a mm	b mm	Halter Retractor
1	70	27	ZA 7060-11	1	75	23	ZA 7060-21
2	75	30	ZA 7060-12	2	80	26	ZA 7060-22
3	90	36	ZA 7060-13	3	95	32	ZA 7060-23



Scheidenspekula, Sets Vaginal Specula, Sets

Maßschema für Spekulum
Scheme of dimensions for specula

a	Blattlänge Length of blade
b	Blattbreite Width of blade

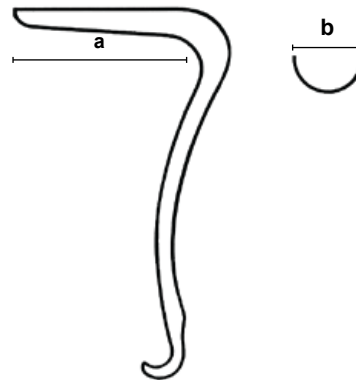

mit konisch verlaufenden
Blättern, für Jungfrauen
*with conically shaped
blades, for virgins*

Scheidenspekulum komplett, bestehend aus: <i>Vaginal specula complete, consisting of:</i>	ZA 7065-01
--	-------------------

- 1 Spekulum Fig. 00, 110 x 18 mm (ZA 7065-11)
- 1 Specula fig. 00, 110 x 18 mm (ZA 7065-11)
- 1 Halter Fig. 00, 115 x 14 mm (ZA 7065-21)
- 1 Retractor fig. 00, 115 x 14 mm (ZA 7065-21)

Scheidenspekulum komplett, bestehend aus: <i>Vaginal specula complete, consisting of:</i>	ZA 7065-02
--	-------------------

- 1 Spekulum Fig. 0, 110 x 21 mm (ZA 7065-12)
- 1 Specula fig. 0, 110 x 21 mm (ZA 7065-12)
- 1 Halter Fig. 0, 115 x 17 mm (ZA 7065-22)
- 1 Retractor fig. 0, 115 x 17 mm (ZA 7065-22)

Fig.	a mm	b mm	Spekulum Specula
00	110	18	ZA 7065-11
0	110	21	ZA 7065-12

Fig.	a mm	b mm	Halter Retractor
00	115	14	ZA 7065-21
0	115	17	ZA 7065-22

KRISTELLER

Scheidenspekula, Sets Vaginal Specula, Sets



Maßschema für Spekulum
Scheme of dimensions for specula

a	Blattlänge Length of blade
b	Blattbreite Width of blade

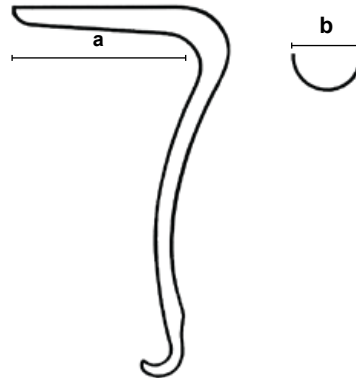

mit besonders
langen Löffeln
with extra
long blades

KRISTELLER

Scheidenspekulum komplett, bestehend aus: Vaginal specula complete, consisting of:	ZA 7070-01
1 Spekulum Fig. 1, 110 x 27 mm (ZA 7070-11) 1 Specula fig. 1, 110 x 27 mm (ZA 7070-11) 1 Halter Fig. 1, 115 x 23 mm (ZA 7070-21) 1 Retractor fig. 1, 115 x 23 mm (ZA 7070-21)	
Scheidenspekulum komplett, bestehend aus: Vaginal specula complete, consisting of:	ZA 7070-02
1 Spekulum Fig. 2, 110 x 30 mm (ZA 7070-12) 1 Specula fig. 2, 110 x 30 mm (ZA 7070-12) 1 Halter Fig. 2, 115 x 26 mm (ZA 7070-22) 1 Retractor fig. 2, 115 x 26 mm (ZA 7070-22)	
Scheidenspekulum komplett, bestehend aus: Vaginal specula complete, consisting of:	ZA 7070-03
1 Spekulum Fig. 3, 110 x 36 mm (ZA 7070-13) 1 Specula fig. 3, 110 x 36 mm (ZA 7070-13) 1 Halter Fig. 3, 115 x 32 mm (ZA 7070-23) 1 Retractor fig. 3, 115 x 32 mm (ZA 7070-23)	

Fig.	a mm	b mm	Spekulum Specula
1	110	27	ZA 7070-11
2	110	30	ZA 7070-12
3	110	36	ZA 7070-13

Fig.	a mm	b mm	Halter Retractor
1	115	23	ZA 7070-21
2	115	26	ZA 7070-22
3	115	32	ZA 7070-23



Scheidenspekula, Sets Vaginal Specula, Sets

Maßschema für Spekulum
Scheme of dimensions for specula

a	Blattlänge Length of blade
b	Blattbreite Width of blade

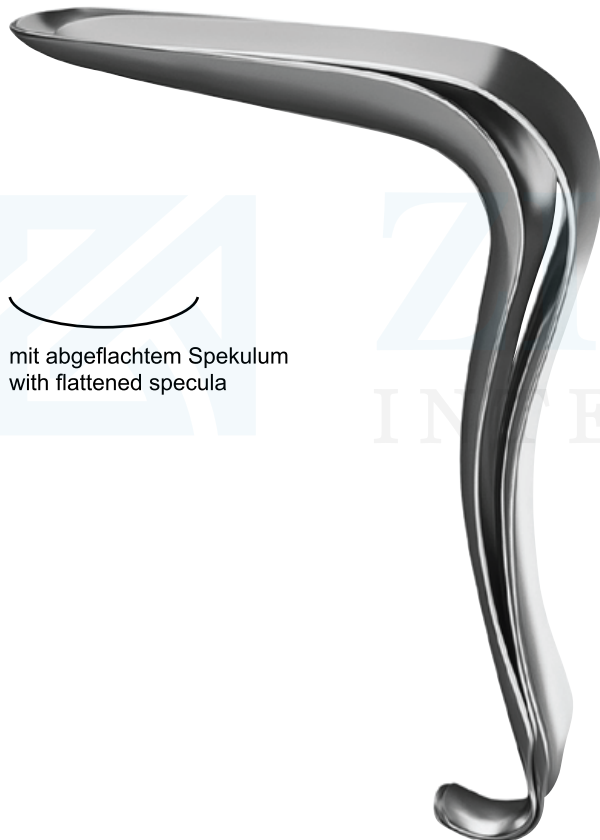
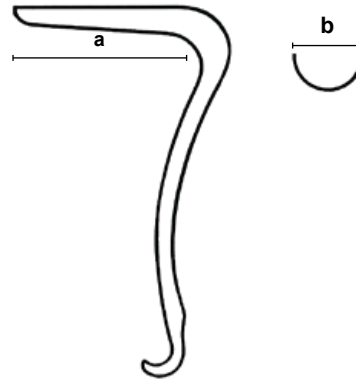

mit abgeflachtem Spekulum
with flattened specula

KRISTELLER

Scheidenspekulum komplett, bestehend aus:
Vaginal specula complete, consisting of: **ZA 7072-01**

- 1 Spekulum Fig. 1, 110 x 27 mm (ZA 7072-11)
- 1 Specula fig. 1, 110 x 27 mm (ZA 7072-11)
- 1 Halter Fig. 1, 115 x 23 mm (ZA 7072-21)
- 1 Retractor fig. 1, 115 x 23 mm (ZA 7072-21)

Scheidenspekulum komplett, bestehend aus:
Vaginal specula complete, consisting of: **ZA 7072-02**

- 1 Spekulum Fig. 2, 110 x 30 mm (ZA 7072-12)
- 1 Specula fig. 2, 110 x 30 mm (ZA 7072-12)
- 1 Halter Fig. 2, 115 x 26 mm (ZA 7072-22)
- 1 Retractor fig. 2, 115 x 26 mm (ZA 7072-22)

Scheidenspekulum komplett, bestehend aus:
Vaginal specula complete, consisting of: **ZA 7072-03**

- 1 Spekulum Fig. 3, 110 x 36 mm (ZA 7072-13)
- 1 Specula fig. 3, 110 x 36 mm (ZA 7072-13)
- 1 Halter Fig. 3, 115 x 32 mm (ZA 7072-23)
- 1 Retractor fig. 3, 115 x 32 mm (ZA 7072-23)

Fig.	a mm	b mm	Spekulum Specula
1	110	27	ZA 7072-11
2	110	30	ZA 7072-12
3	110	36	ZA 7072-13

Fig.	a mm	b mm	Halter Retractor
1	115	23	ZA 7072-21
2	115	26	ZA 7072-22
3	115	32	ZA 7072-23

Scheidenspekula Vaginal Specula



Maßschema für Spekulum
Scheme of dimensions for specula

a	Blattlänge Length of blade
b	Blattbreite Width of blade

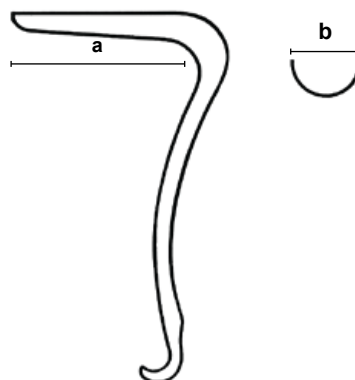

a mm	b mm	
100	20	ZA 7073-01
100	25	ZA 7073-02
100	30	ZA 7073-03
100	35	ZA 7073-04
100	40	ZA 7073-05

a mm	b mm	
130	20	ZA 7073-11
130	25	ZA 7073-12
130	30	ZA 7073-13
130	35	ZA 7073-14
130	40	ZA 7073-15



a mm	b mm	18 cm – 7"
56	13	ZA 7074-00



a mm	b mm	18 cm – 7"
60	10	ZA 7075-00



Scheidenspekula Vaginal Specula

Maßschema für Spekulum
Scheme of dimensions for specula

a	Blattlänge <i>Length of blade</i>
b	Blattbreite <i>Width of blade</i>

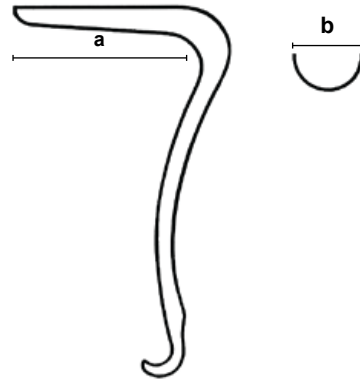

ZIMAIZ
INTERNATIONAL

a mm	b mm	19 cm – 7½"
85	17	ZA 7077-00

Scheidenspekula Vaginal Specula



Maßschema für Spekulum
Scheme of dimensions for specula

a	Blattlänge Length of blade
b	Blattbreite Width of blade

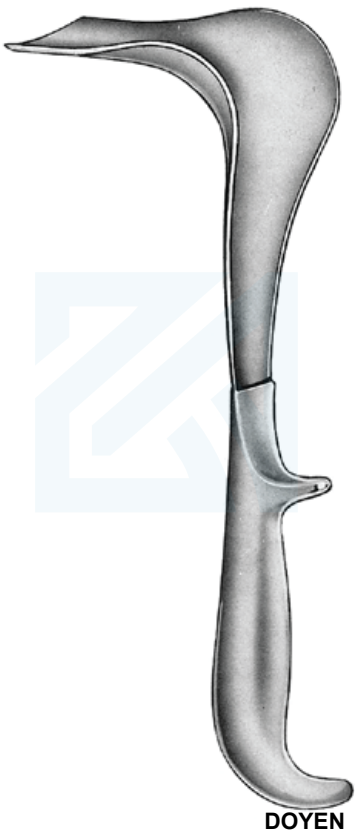
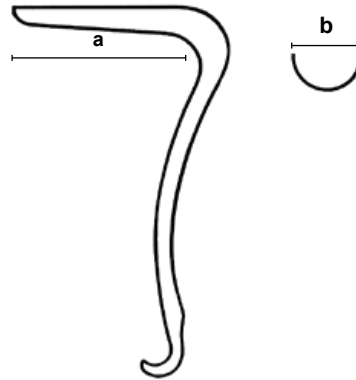

ZIMAIZ
INTERNATIONAL

Fig.	a mm	b mm	
1	75	45	ZA 7080-11
2	90	45	ZA 7080-12
3	110	45	ZA 7080-13



Scheidenspekula Vaginal Specula

Maßschema für Spekulum
Scheme of dimensions for specula

a	Blattlänge Length of blade
b	Blattbreite Width of blade

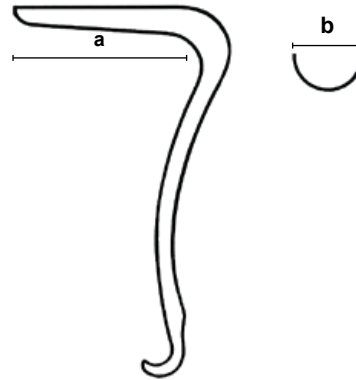

DOYEN

24 cm – 9½"

Fig.	a mm	b mm	leicht hohl ly-concave
1	55	35	ZA 7080-01
2	85	35	ZA 7080-02
3	115	35	ZA 7080-03
1	55	45	ZA 7081-01
2	85	45	ZA 7081-02
3	115	45	ZA 7081-03
4	160	45	ZA 7081-04
1	55	60	ZA 7082-01
2	85	60	ZA 7082-02
3	115	60	ZA 7082-03
4	160	60	ZA 7082-04

Scheidenspekula Vaginal Specula



Maßschema für Spekulum
Scheme of dimensions for specula

a	Blattlänge Length of blade
b	Blattbreite Width of blade

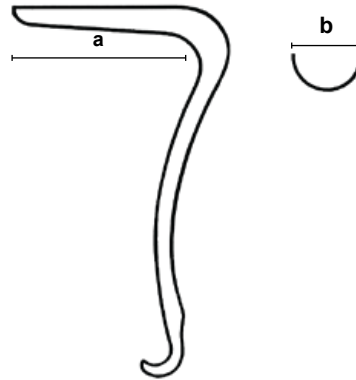

DOYEN

24 cm – 9½"

Fig.	a mm	b mm	halbhohlmedi um-concave-
1	55	35	ZA 7083-01
2	85	35	ZA 7083-02
3	115	35	ZA 7083-03
1	55	45	ZA 7084-01
2	85	45	ZA 7084-02
3	115	45	ZA 7084-03
1	55	60	ZA 7085-01
2	85	60	ZA 7085-02
3	115	60	ZA 7085-03



Scheidenspekula Vaginal Specula

Maßschema für Spekulum
Scheme of dimensions for specula

a	Blattlänge <i>Length of blade</i>
b	Blattbreite <i>Width of blade</i>

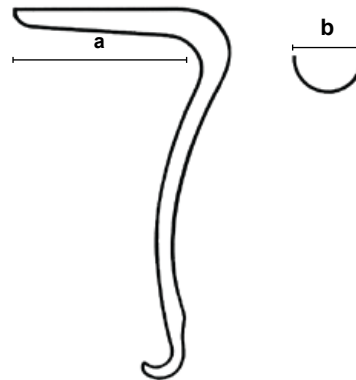

BREISKY

a mm	b mm	
100	20	ZA 7090-20
100	25	ZA 7090-25
100	30	ZA 7090-30
100	35	ZA 7090-35
100	40	ZA 7090-40
130	20	ZA 7091-20
130	25	ZA 7091-25
130	30	ZA 7091-30
130	35	ZA 7091-35
130	40	ZA 7091-40
160	20	ZA 7092-20
160	25	ZA 7092-25
160	30	ZA 7092-30
160	35	ZA 7092-35
160	40	ZA 7092-40
180	20	ZA 7093-20
180	25	ZA 7093-25
180	30	ZA 7093-30
180	35	ZA 7093-35
180	40	ZA 7093-40

Scheidenhalter Vaginal Retractors



Maßschema für Spekulum
Scheme of dimensions for specula

a	Blattlänge Length of blade
b	Blattbreite Width of blade

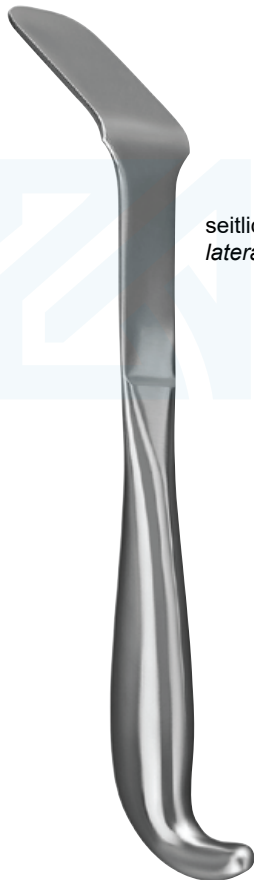
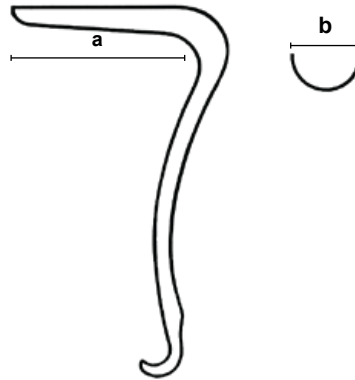

seitliches Spekulum
lateral speculum

DOYEN

a mm	b mm	25 cm – 10"
60	30	ZA 7086-01
70	30	ZA 7086-02
80	30	ZA 7086-25



HÖSEL

	25 cm – 10"
60 x 20 mm	ZA 4542-01
80 x 30 mm	ZA 4542-02
100 x 30 mm	ZA 4542-03
120 x 30 mm	ZA 4542-04
140 x 30 mm	ZA 4542-05
140 x 40 mm	ZA 4542-06



Scheidenspekula Vaginal Specula

Maßschema für Spekulum
Scheme of dimensions for specula

a	Blattlänge Length of blade
b	Blattbreite Width of blade

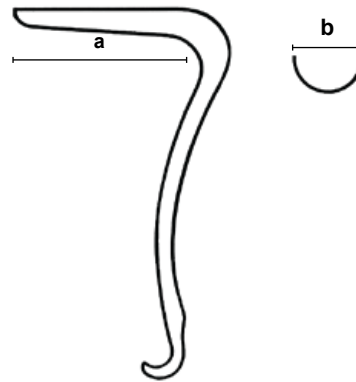

mit abnehmbarem Gewicht
with detachable weight

AUVARDA

1:3

a mm	b mm	
80	38	ZA 7088-00
105	42	ZA 7088-10



mit festem Gewicht
with fixed weight

AUVARD

1:3

a mm	b mm	
70	38	ZA 7088-51
102	45	ZA 7088-52

Scheidenspekula Vaginal Specula



Maßschema für Spekulum
Scheme of dimensions for specula

a	Blattlänge Length of blade
b	Blattbreite Width of blade

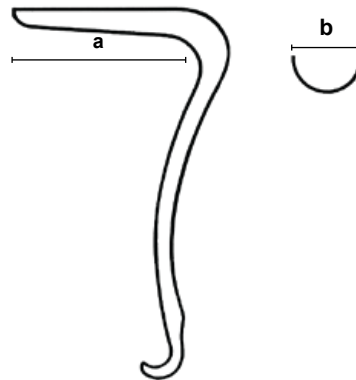

Scheidenspekulum komplett, bestehend aus: Vaginal specula complete, consisting of:	ZA 7095-00
1 Griff (ZA 7095-14) ZA	
1 Handle (ZA 7095-14)	
1 Gewicht, leicht, 400 g (ZA 7095-10)	
1 Weight, light, 400 g (ZA 7095-10)	
5 Blätter (1 Stück) (ZA 7095-01, -02, -03, -04, -05)	
5 Blades (1 piece) (ZA 7095-01, -02, -03, -04, -05)	



SCHERBAK



Griff
Handle
ZA 7095-14

Gewicht, leicht, 400 g
Weight, light, 400 g
ZA 7095-10

Gewicht, schwer, 800 g
Weight, heavy, 800 g
ZA 7095-12





Uterusdilatoren Uterine Dilators



HEGAR

Ø mm	
1	ZA 7100-01
2	ZA 7100-02
3	ZA 7100-03
4	ZA 7100-04
5	ZA 7100-05
6	ZA 7100-06
7	ZA 7100-07
8	ZA 7100-08
9	ZA 7100-09
10	ZA 7100-10
11	ZA 7100-11
12	ZA 7100-12
13	ZA 7100-13
14	ZA 7100-14
15	ZA 7100-15

Ø mm	
16	ZA 7100-16
17	ZA 7100-17
18	ZA 7100-18
19	ZA 7100-19
20	ZA 7100-20
21	ZA 7100-21
22	ZA 7100-22
23	ZA 7100-23
24	ZA 7100-24
25	ZA 7100-25
26	ZA 7100-26
27	ZA 7100-27
28	ZA 7100-28
29	ZA 7100-29
30	ZA 7100-30

Ø mm	
1,5	ZA 7101-01
2,5	ZA 7101-02
3,5	ZA 7101-03
4,5	ZA 7101-04
5,5	ZA 7101-05
6,5	ZA 7101-06
7,5	ZA 7101-07
8,5	ZA 7101-08
9,5	ZA 7101-09
10,5	ZA 7101-10
11,5	ZA 7101-11
12,5	ZA 7101-12
13,5	ZA 7101-13
14,5	ZA 7101-14
15,5	ZA 7101-15
16,5	ZA 7101-16
17,5	ZA 7101-17
18,5	ZA 7101-18
19,5	ZA 7101-19



HEGAR

Ø mm	
1 / 2	ZA 7102-02
3 / 4	ZA 7102-04
5 / 6	ZA 7102-06
7 / 8	ZA 7102-08
9 / 10	ZA 7102-10
11 / 12	ZA 7102-12
13 / 14	ZA 7102-14
15 / 16	ZA 7102-16
17 / 18	ZA 7102-18
19 / 20	ZA 7102-20
21 / 22	ZA 7102-22
23 / 24	ZA 7102-24
25 / 26	ZA 7102-26

Stück per Satz Pieces per set	Satz Set
8 St. / pcs. (3 / 4 – 17 / 18 mm)	ZA 7102-30
13 St. / pcs. (1 / 2 – 25 / 26 mm)	ZA 7102-40



8 Stück (3 / 4 – 17 / 18 mm) in auskochbarer Rolltasche	ZA 7102-50
8 pieces (3 / 4 – 17 / 18 mm) in boilable canvas roll	
Rolltasche, allein Canvas roll, only	ZA 7102-51



GODELL

1:3

34 cm – 13½"
ZA 7120-34

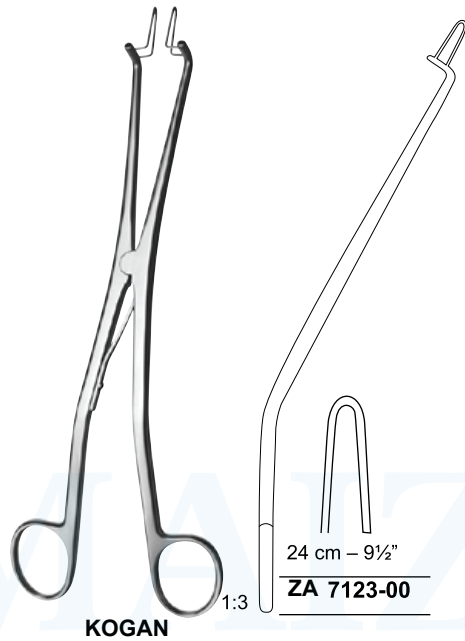

KOGAN

1:3

24 cm – 9½"
ZA 7123-00

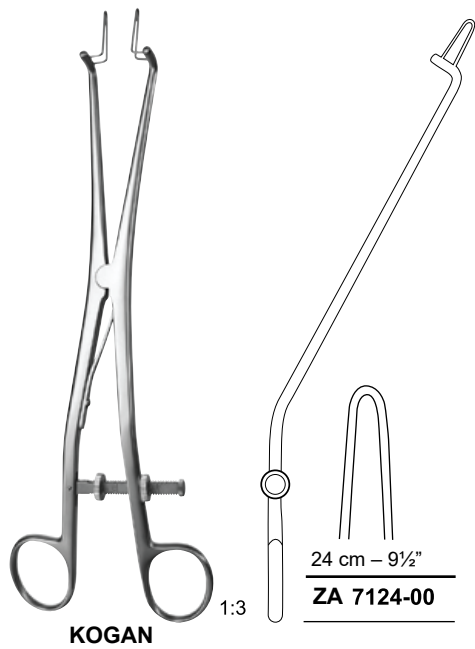

KOGAN

1:3

24 cm – 9½"
ZA 7124-00

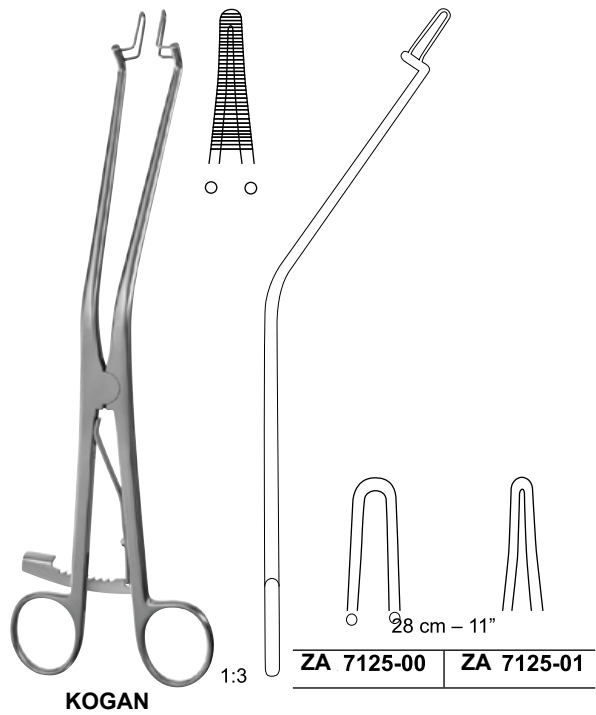

KOGAN

1:3

28 cm – 11"
ZA 7125-00 | **ZA 7125-01**



Uterussonden Uterine Probes

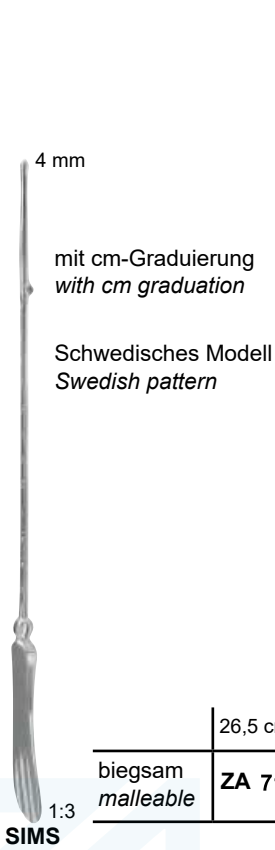

	26,5 cm – 10½"
biegsam <i>malleable</i>	ZA 7128-00

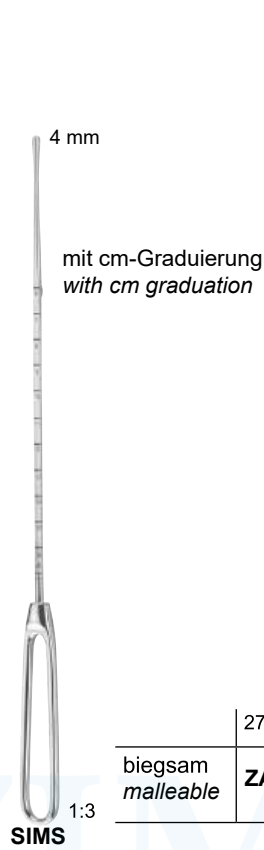

	27,5 cm – 10¾"
biegsam <i>malleable</i>	ZA 7128-10

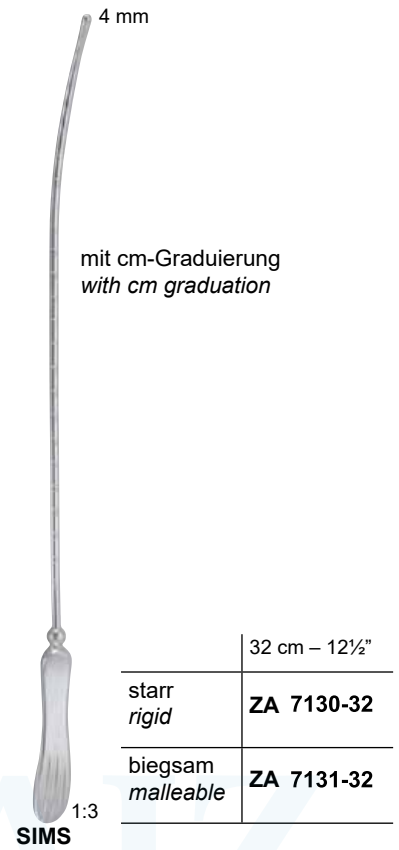

	32 cm – 12½"
starr <i>rigid</i>	ZA 7130-32
biegsam <i>malleable</i>	ZA 7131-32

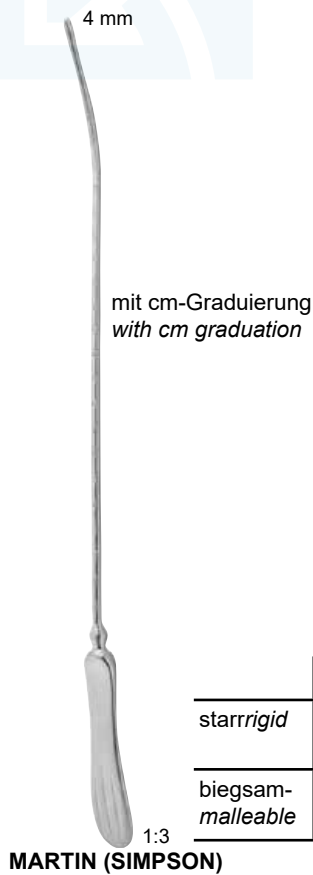

	32 cm – 12½"
starr <i>rigid</i>	ZA 7133-32
biegsam- <i>malleable</i>	ZA 7134-32



	29,5 cm – 11½"
	ZA 7135-25



	28 cm – 11"
	ZA 7138-27



SCHACKE

23 cm – 9"
ZA 7150-00



27 cm – 10½"
ZA 7284-00

1:3

ZIMAIZ
INTERNATIONAL

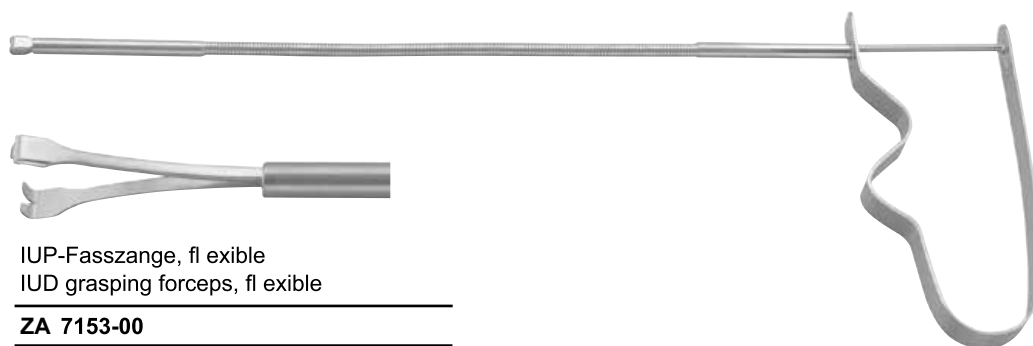

IUP-Fasszange, fl exible
IUD grasping forceps, fl exible

ZA 7153-00



Hakenzangen Uterine Tenaculum Forceps

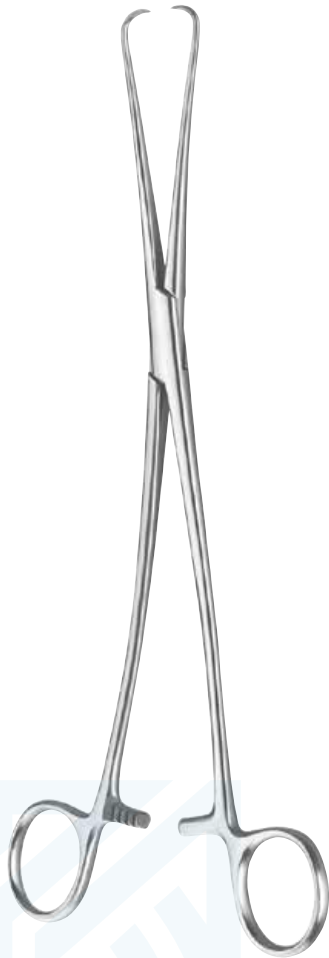

KAHN

24,5 cm – 9¾"
ZA 7157-24



MARTIN

27 cm – 10½"
ZA 7158-27

1:3



BARRETT

18 cm – 7"
ZA 7159-03



SCHRÖDER

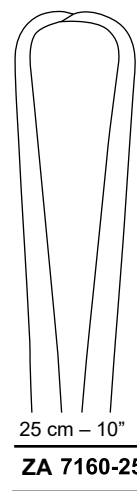

25 cm – 10"
ZA 7160-25

1:3

Hakenzangen Uterine Tenaculum Forceps

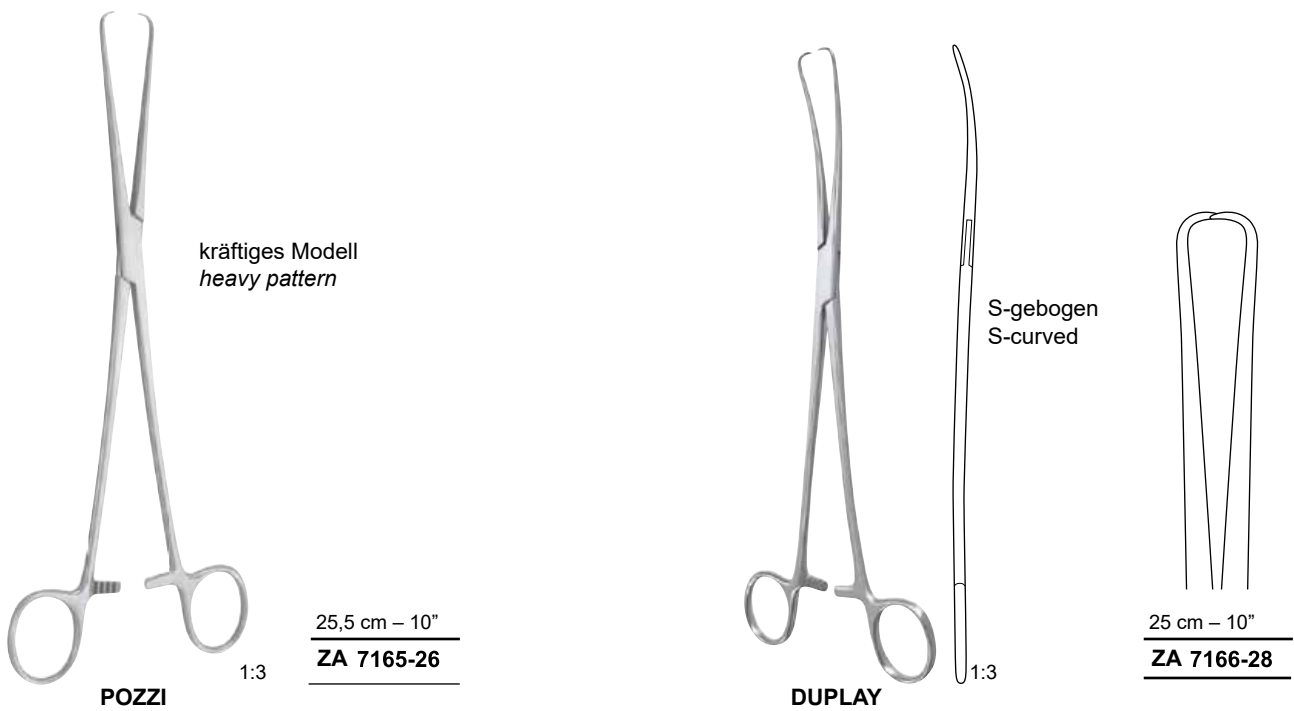
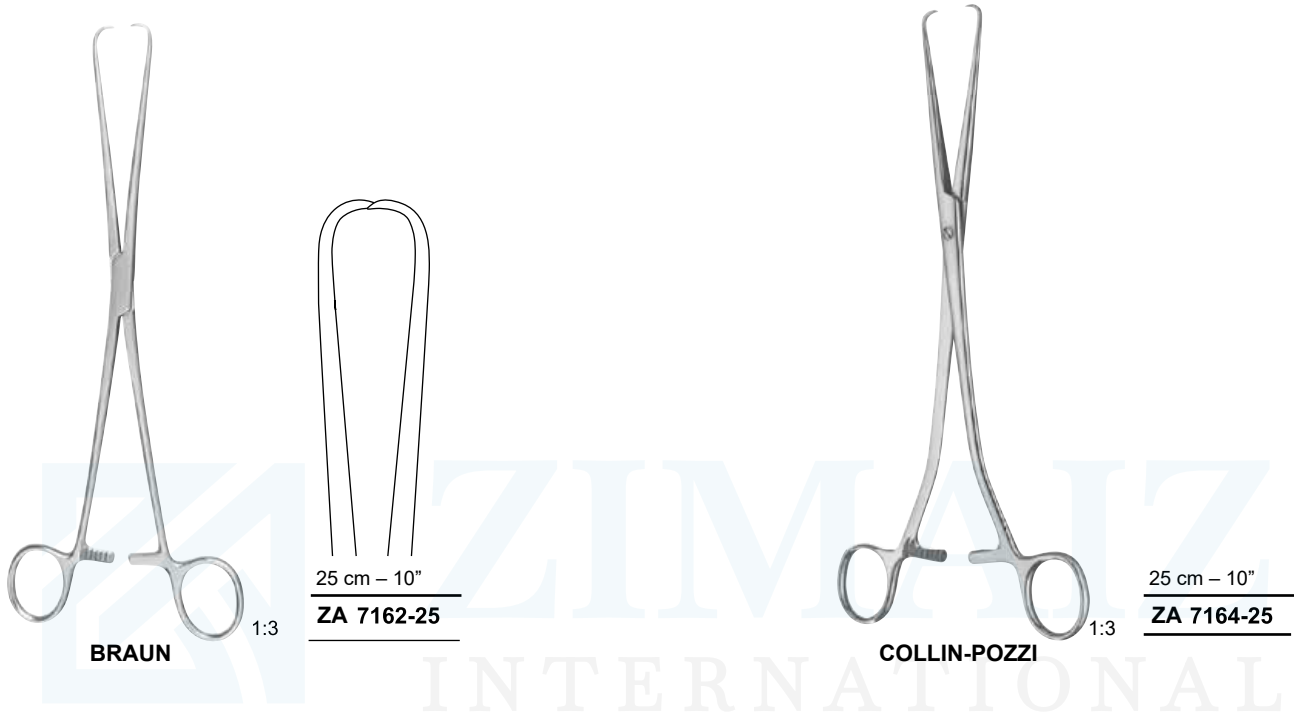



Hakenzangen Uterine Tenaculum Forceps

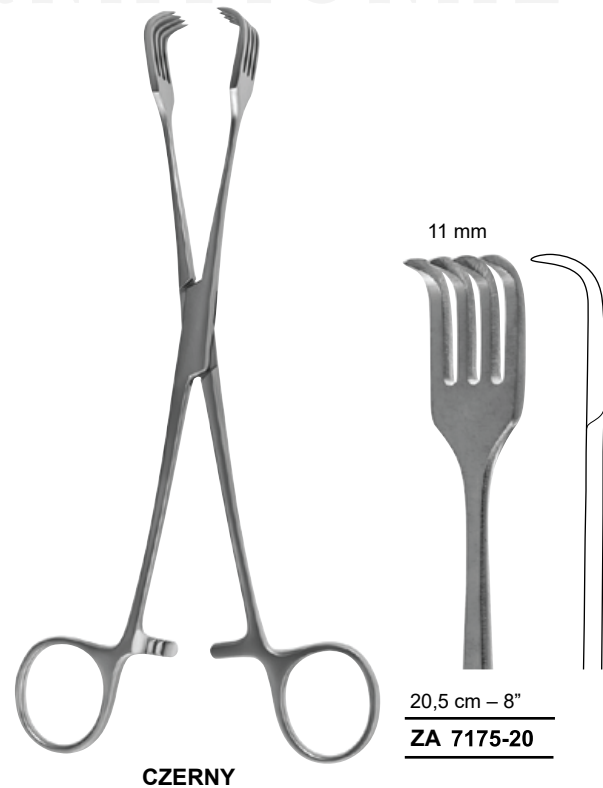
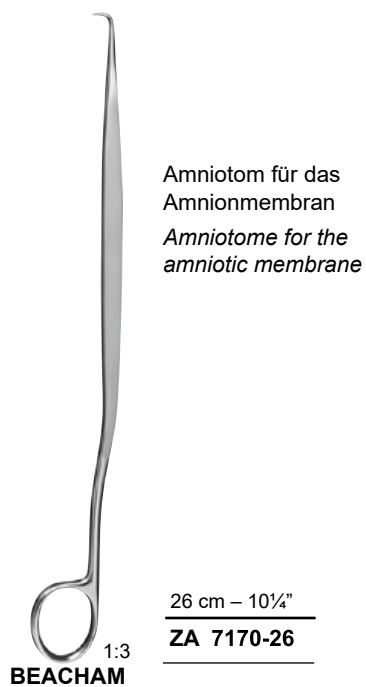
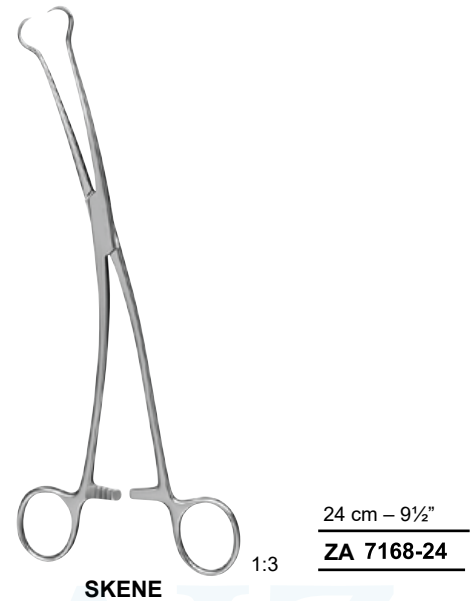
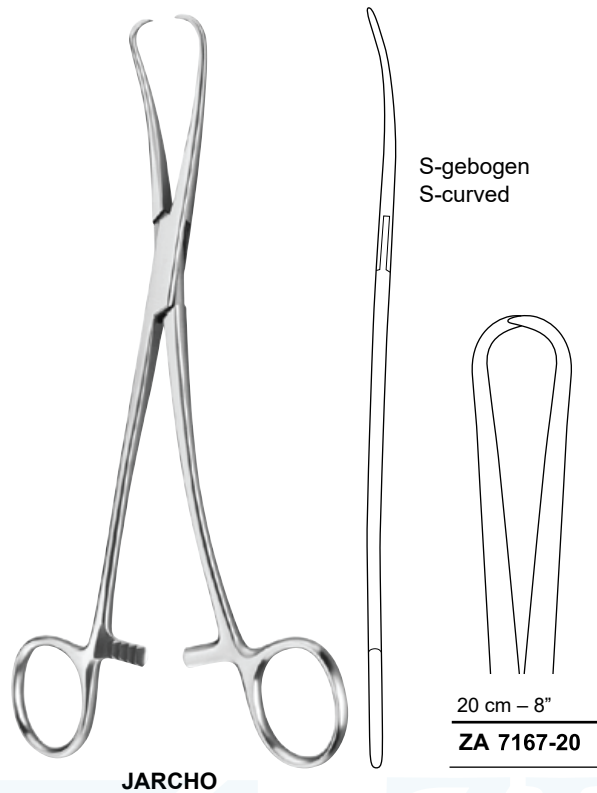

Hakenzangen Uterine Tenaculum Forceps

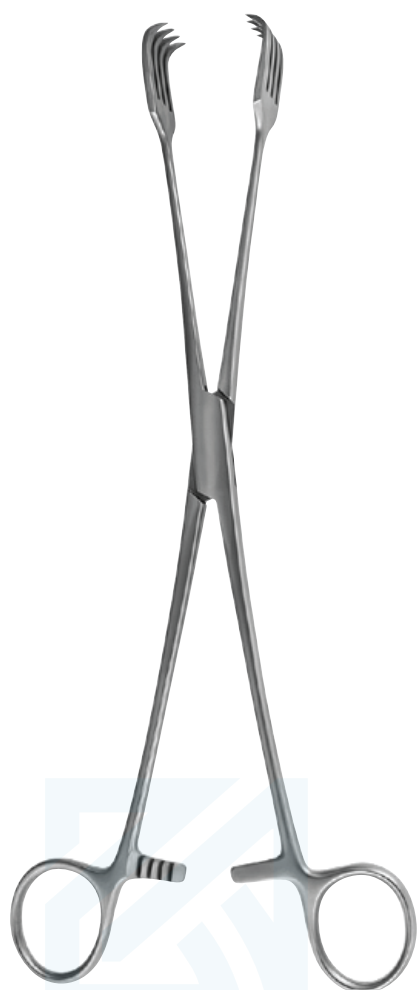

PRATT



26 cm – 10¼"

ZA 7178-26

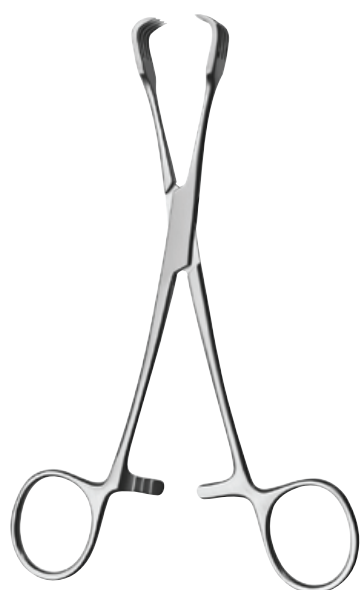

BRAUN



15,5 cm – 6"

ZA 7197-16



Hakenzangen Uterine Tenaculum Forceps



SCHRÖDER



gerade
straight

20 cm – 8"	ZA 7180-20
24 cm – 9½"	ZA 7180-24



SCHRÖDER



aufgebogen
curved on flat



seitlich gebogen
curved sideways

20 cm – 8"	ZA 7181-20	ZA 7182-20
24 cm – 9½"	ZA 7181-24	ZA 7182-24

Hakenzangen Uterine Tenaculum Forceps



MUSEUX



gerade
straight

21 cm – 8¼"

ZA 7189-20

ZIMAIZ
INTERNATIONAL

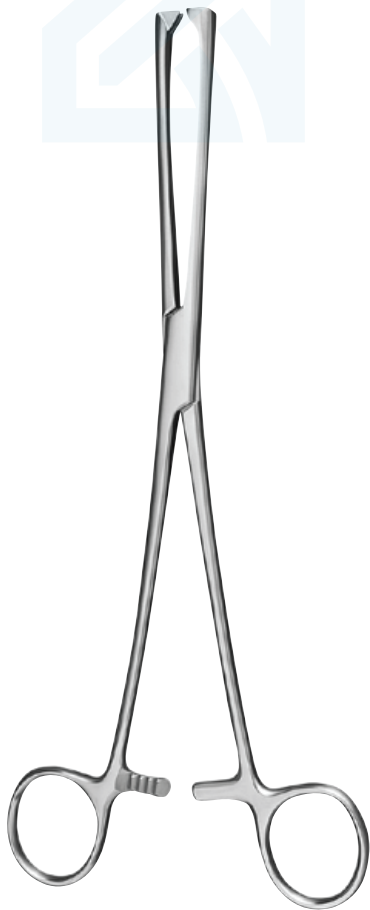

MUSEUX

1:3



gerade
straight

24 cm – 9½"

6 mm

8 mm

10 mm

ZA 7190-06

ZA 7190-08

ZA 7190-10



Hakenzangen Uterine Tenaculum Forceps

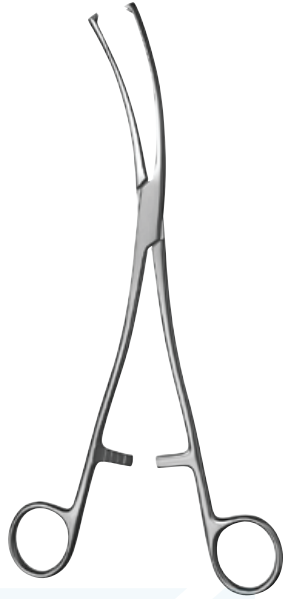

MUSEUX

1:3



seitlich gebogen
curved sideways

24 cm – 9½"

6 mm	8 mm	10 mm
ZA 7191-06	ZA 7191-08	ZA 7191-10



TEALE



3 : 4 Zähne
3 : 4 teeth

seitlich gebogen
curved sideways

23 cm – 9"

ZA 7200-23

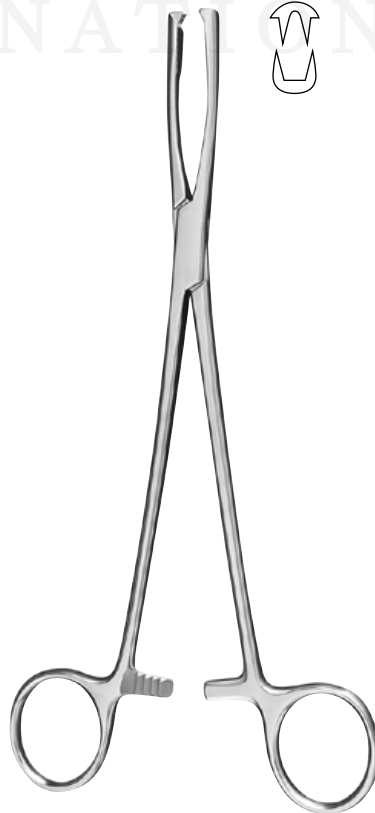

JACOBS



gerade
straight

21 cm – 8¼"

ZA 7210-21

Polypen- und Ovarienzangen
Polypus and Ovary Forceps



DE LEE

1:3



gerade
straight

24 cm – 9½"

ZA 7212-24



VAUT

1:3



aufgebogen
curved on flat

26 cm – 10¼"

ZA 7214-26



KELLY

1:3



aufgebogen
curved on flat

32 cm – 12½"

ZA 7215-32



BONNEY

1:3



gerade
straight

24 cm – 9½"

ZA 7216-24





Polypen- und Ovarienzangen Polypus and Ovary Forceps

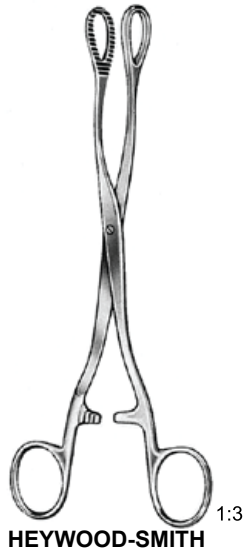

gerade
straight

20 cm – 8"
ZA 6616-20



gerade
straight

25 cm – 10"
ZA 7218-25



ZIMAIZ
INTERNATIONAL



27 cm – 10½"
ZA 7219-27

Uterusfasszangen Uterine Elevating Forceps



DRATIGUES

1:3

27 cm – 10½"

ZA 7222-27



SOMER

1:3

23 cm – 9"

ZA 7223-23



ZIMAIZ
INTERNATIONAL



COLLIN

1:3

mit beweglichen Maulteilen
with moveable jaws

25 cm – 10"

ZA 7224-25



COLLIN

1:3

28,5 cm – 11¼"

ZA 7225-28



Uterusfazzangen Uterine Elevating Forceps

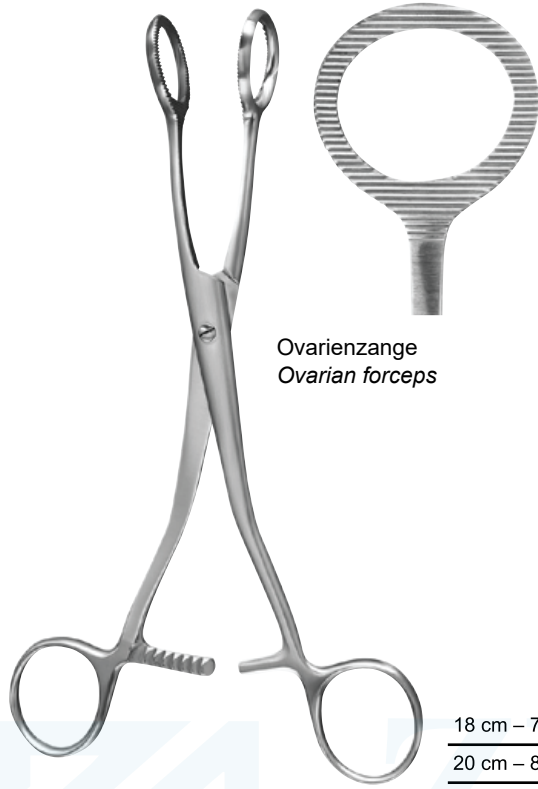

Ovarienszange
Ovarian forceps

DOYEN

18 cm – 7"	ZA 7226-18
20 cm – 8"	ZA 7226-20



ZIMAIZ
INTERNATIONAL

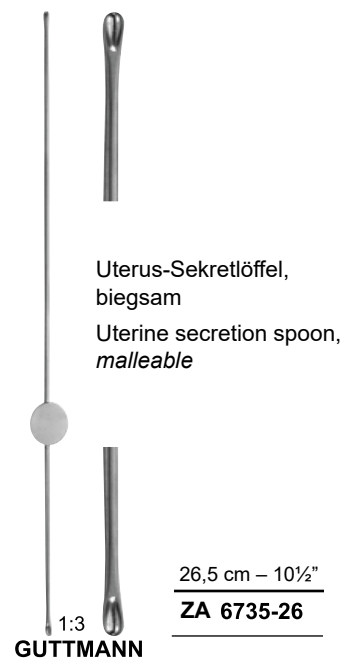
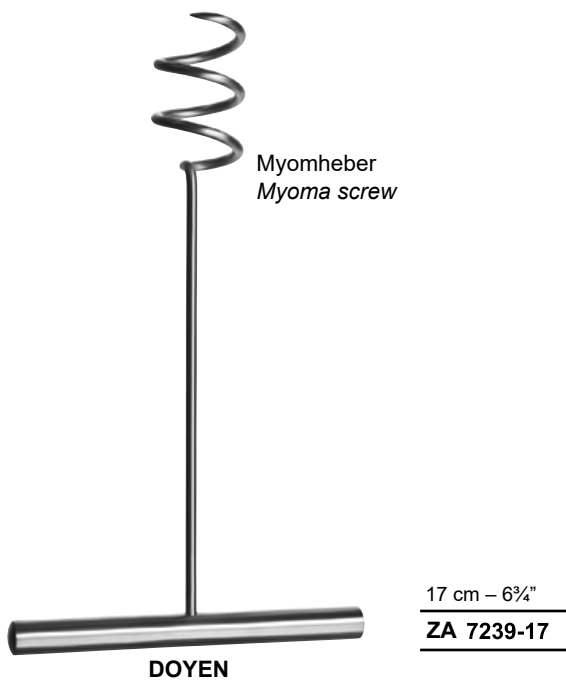
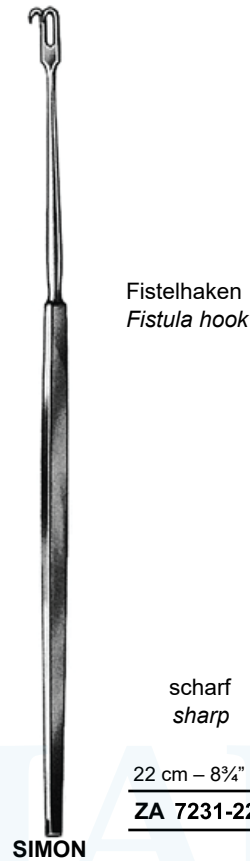
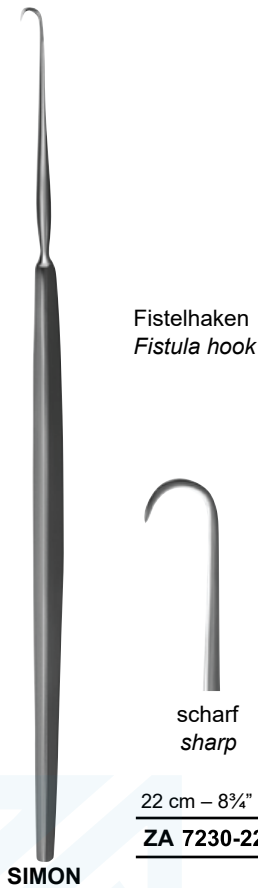



Parametriumklemmen Parametrium Forceps



gerade
straight

22,5 cm – 8¾"

ZA 3383-01



leicht gebogen
slightly curved

22 cm – 8¾"

ZA 3383-02



stark gebogen
strongly curved

21,5 cm – 8½"

ZA 3383-03



gebogen
curved

20,5 cm – 8"

ZA 3383-04



ROGERS



DE BAKEY Zahnung
DE BAKEY Serration

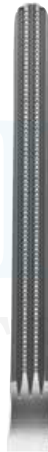

gerade
straight

25 cm – 10"

ZA 3383-51



leicht gebogen
slightly curved

24,5 cm – 9¾"

ZA 3383-52



stark gebogen
strongly curved

24 cm – 9½"

ZA 3383-53



gebogen
curved

23 cm – 9"

ZA 3383-54

Parametriumklemmen Parametrium Forceps

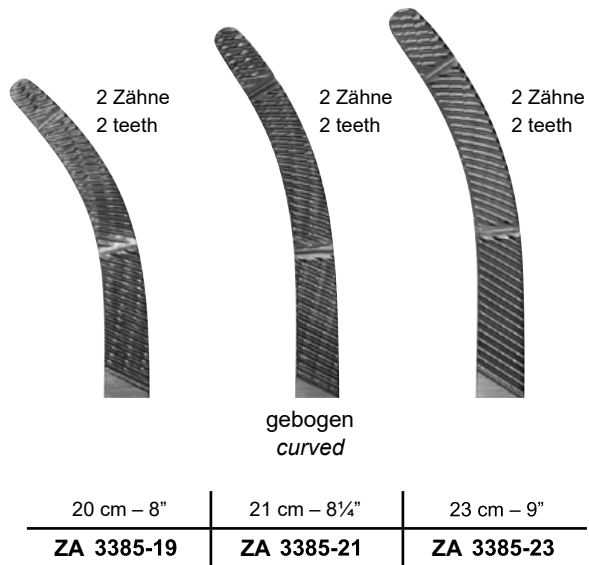
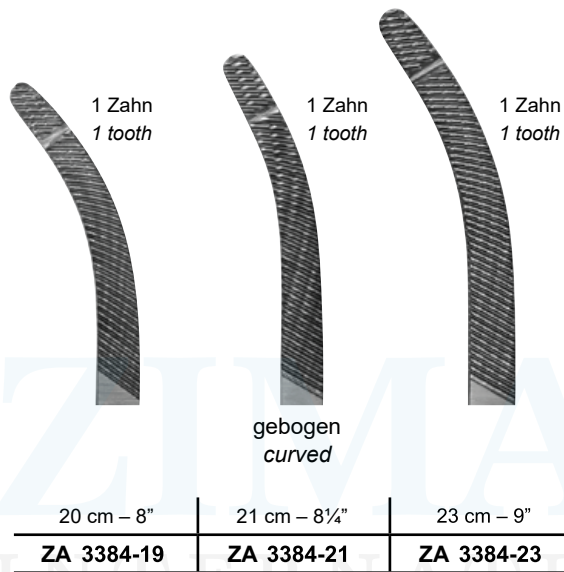



Parametriumklemmen
Parametrium Forceps



1 Zahn
1 tooth

gebogen
curved

21 cm – 8¼"

ZA 3384-41

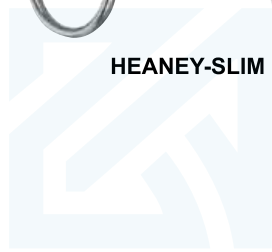

ZIMAIZ
INTERNATIONAL

Hysterektomieklemmen Hysterectomy Forceps

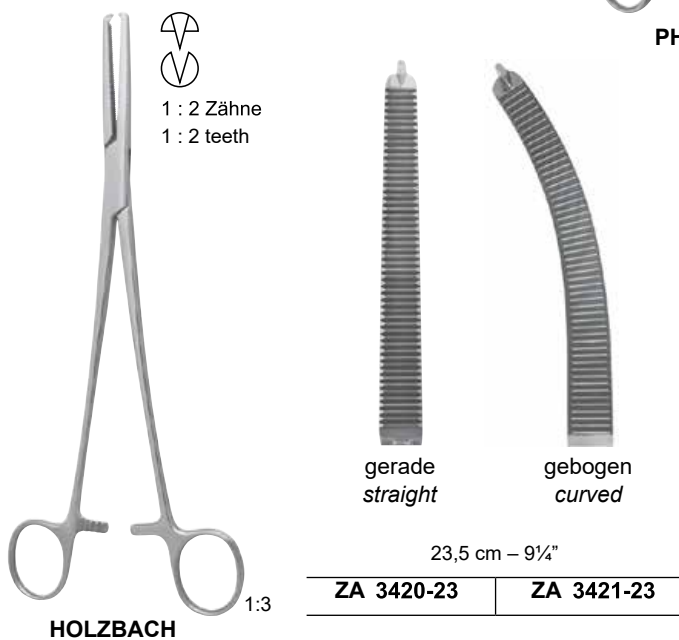
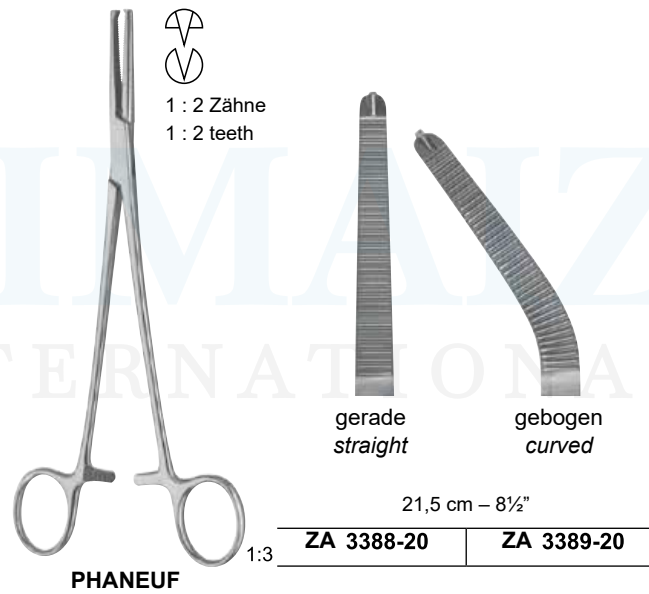



Hysterektomieklemmen Hysterectomy Forceps

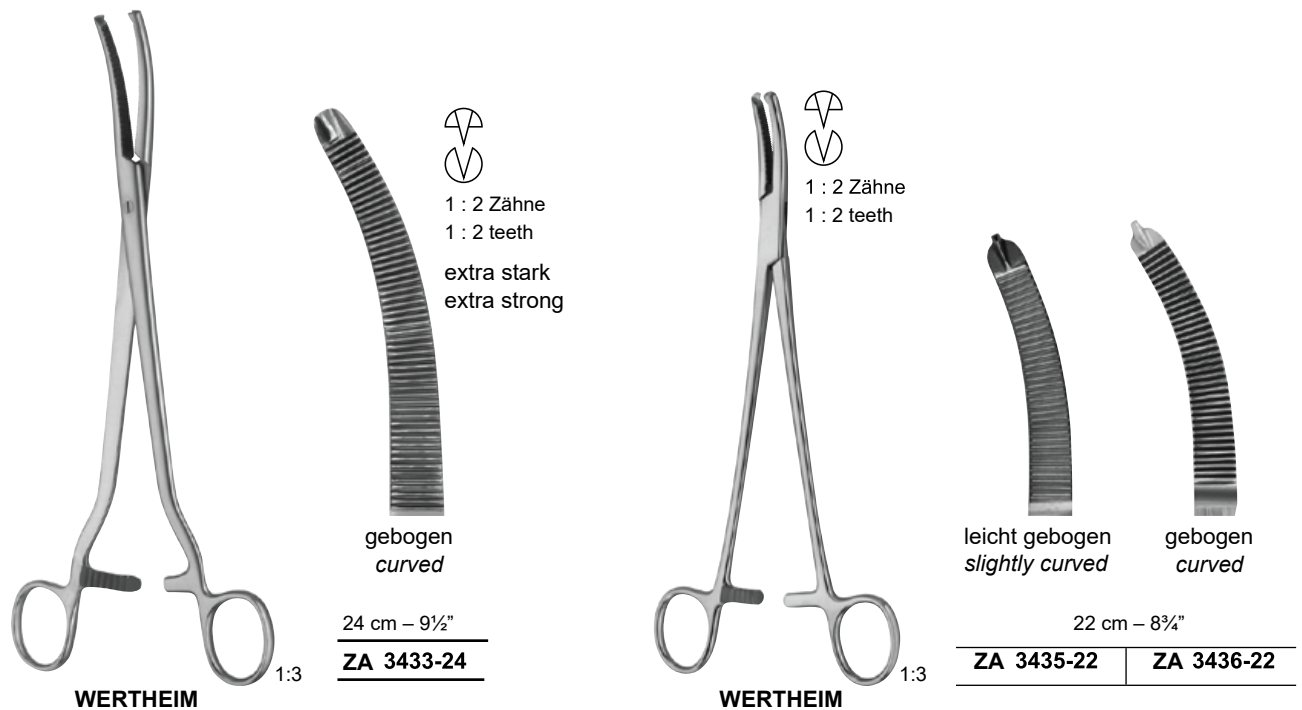

Vaginalklemmen
Vaginal Forceps

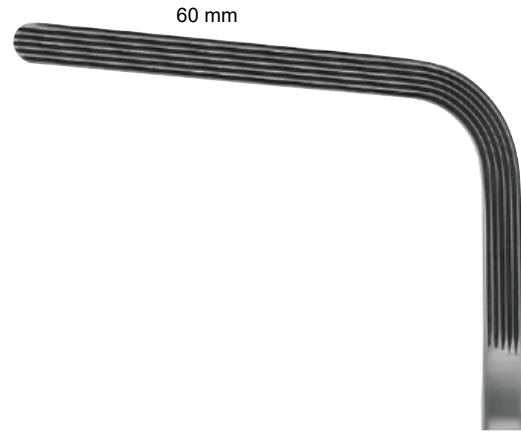

60 mm

23 cm – 9"

ZA 3434-01

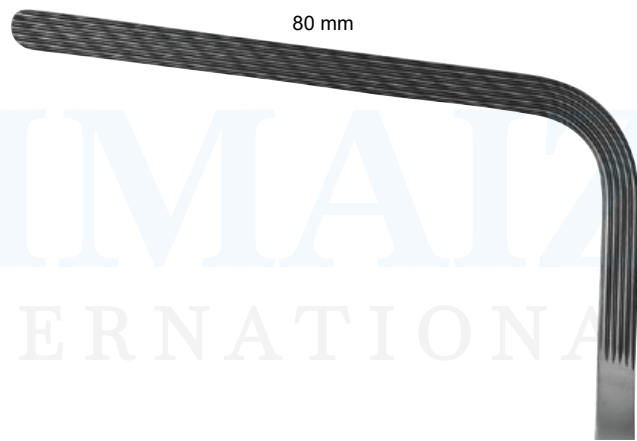

80 mm

23 cm – 9"

ZA 3434-02

ZIMAIZ INTERNATIONAL



Biopsieinstrumente Biopsy Instruments

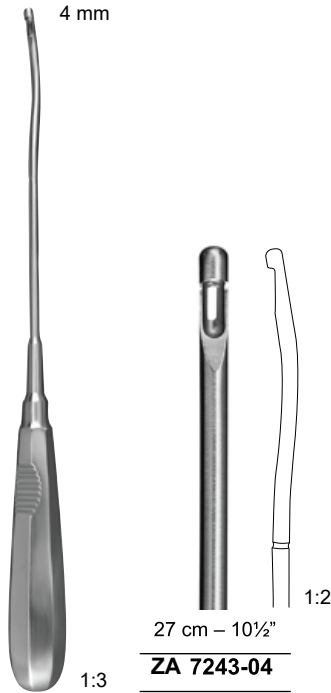

**MÜNCHEN MODELL
MUNICH PATTERN**

für Endometrie
for endometrie

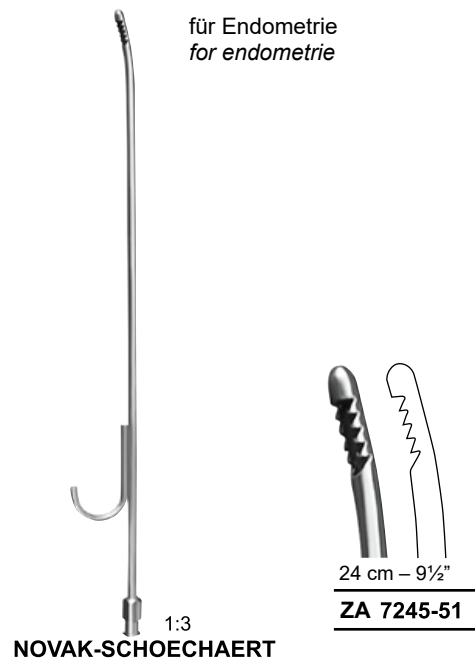
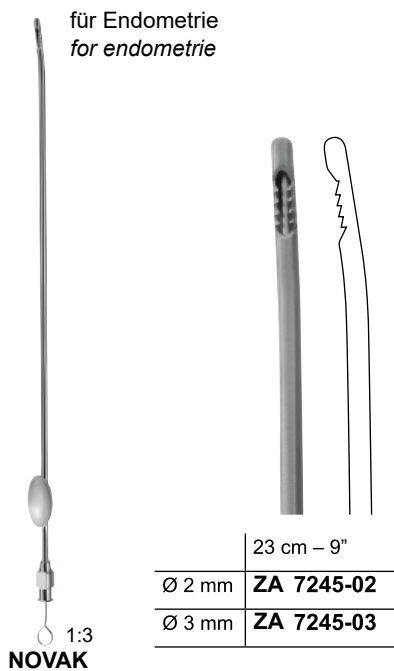
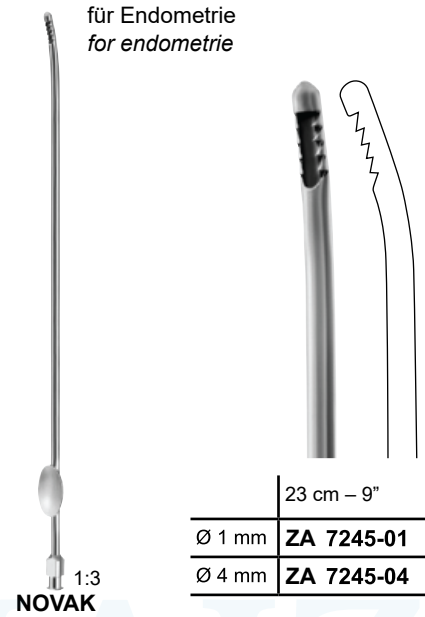

Biopsieküretten
Biopsy Currettes

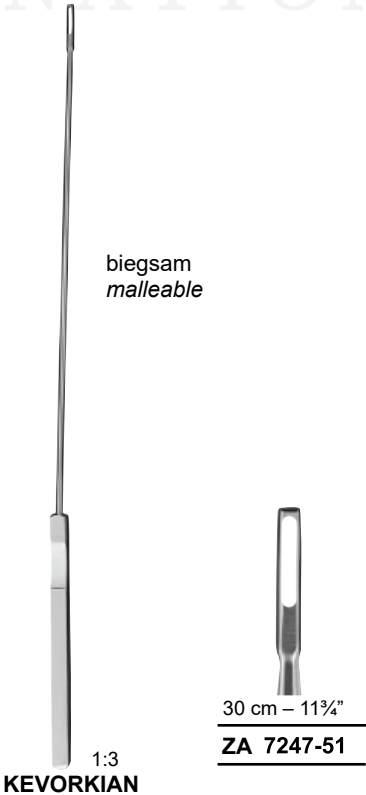
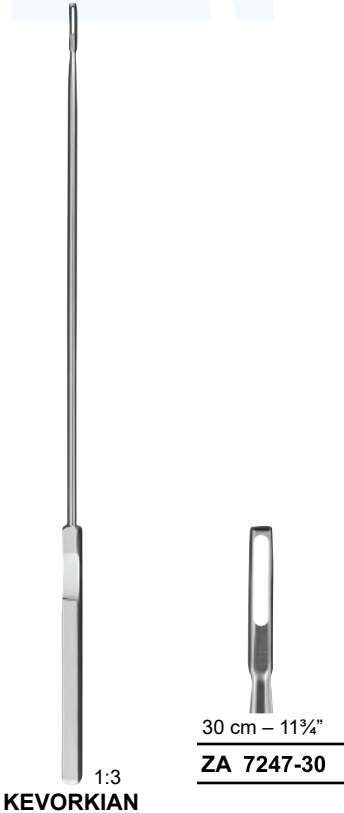
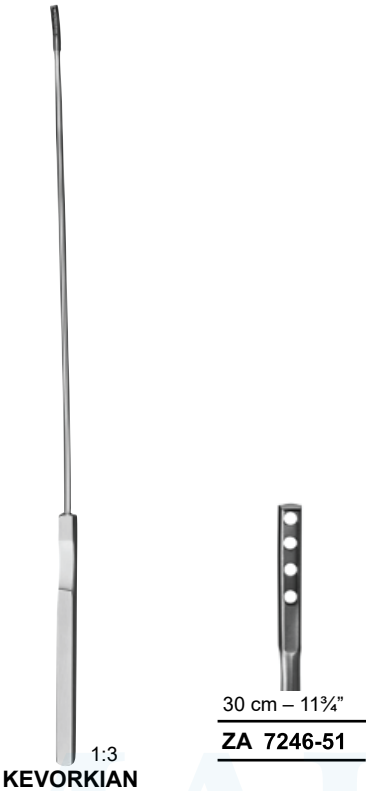
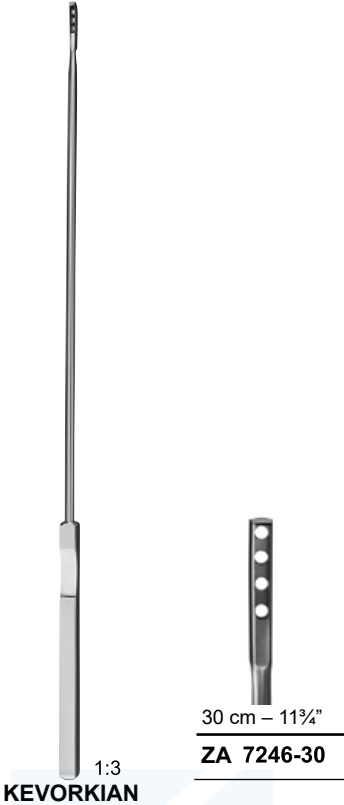

ZIMAIZ
INTERNATIONAL



Biopsiezangen
Biopsy Forceps

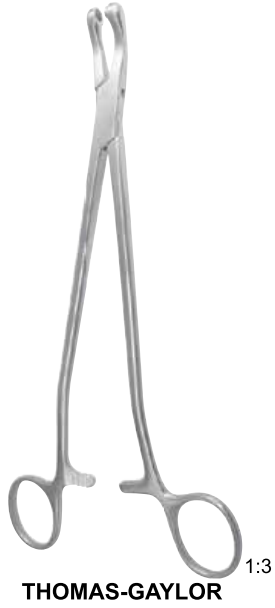

24 cm – 9½"

ZA 7252-24

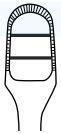
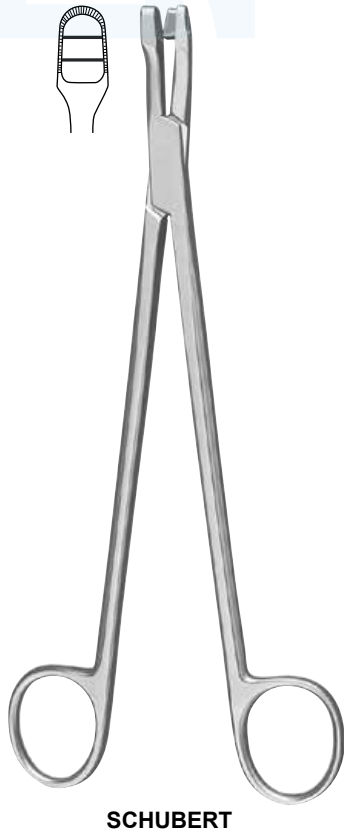

21 cm – 8¼" **ZA 7255-21**

29 cm – 11½" **ZA 7255-29**

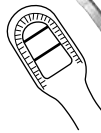
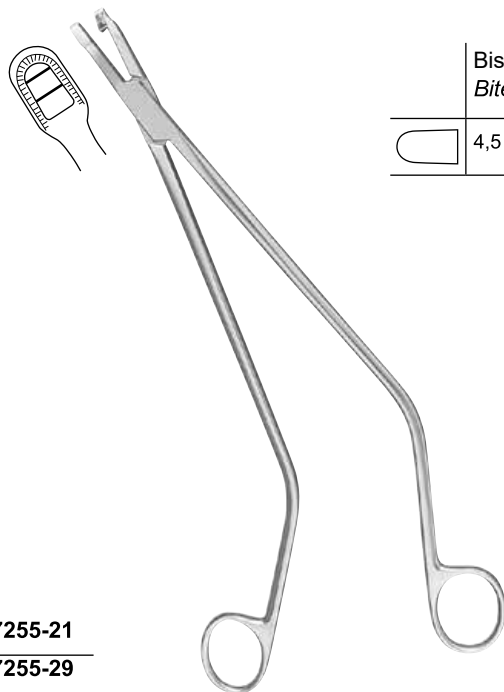

Bissbreite
Bite width

4,5 x 8 mm

1:3



26 cm – 10¼"

ZA 7256-26



TISCHLER



27 cm – 10½"

ZA 7257-27

Bissbreite Bite width	
	4 x 7 mm

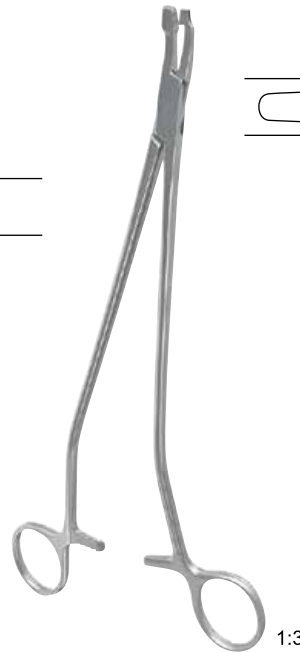

VAN DOREN

Bissbreite
Bite width

	3,5 / 4 x 7 mm
--	----------------

25 cm – 10"

ZA 7258-01



ZIMAIZ
INTERNATIONAL



VAN DOREN

25 cm – 10"

ZA 7258-25



SCHUMACHER



24 cm – 9½"

Fig. 1

Fig. 2

ZA 7261-24

ZA 7262-24



Biopsiezangen
Biopsy Forceps



21 cm – 8¼"

ZA 7263-21

FAURE



ZIMAIZ
INTERNATIONAL

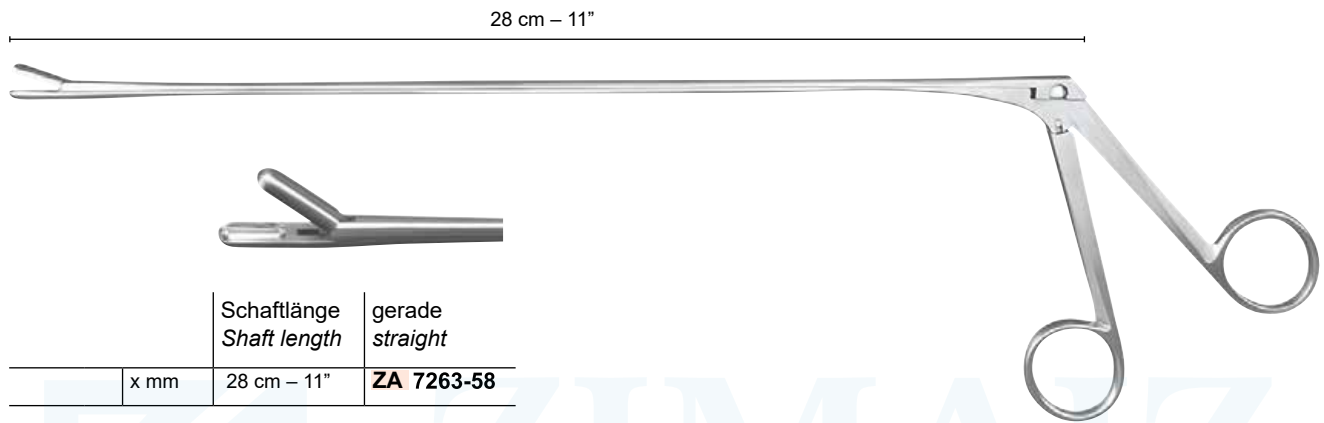

PATTERSON



ZA

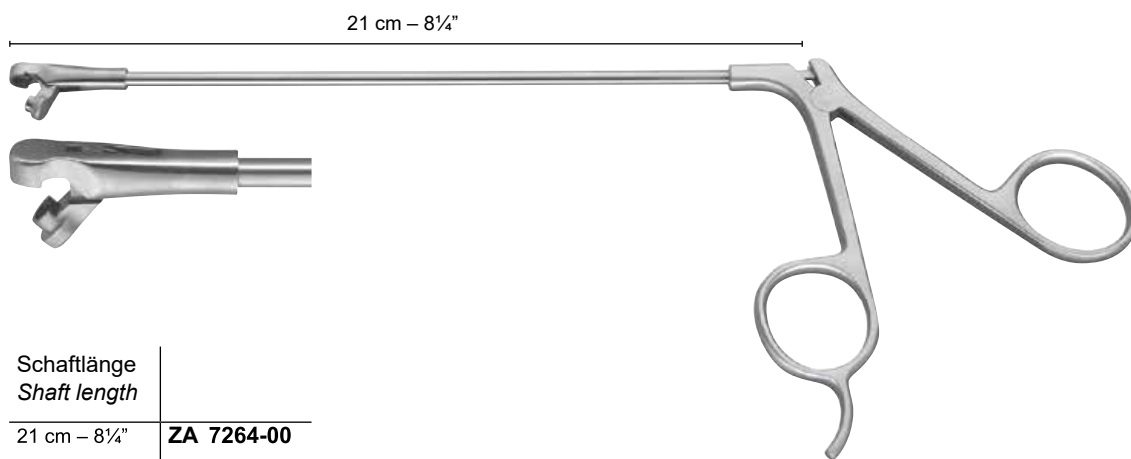

BERGER



Biopsiezangen Biopsy Forceps

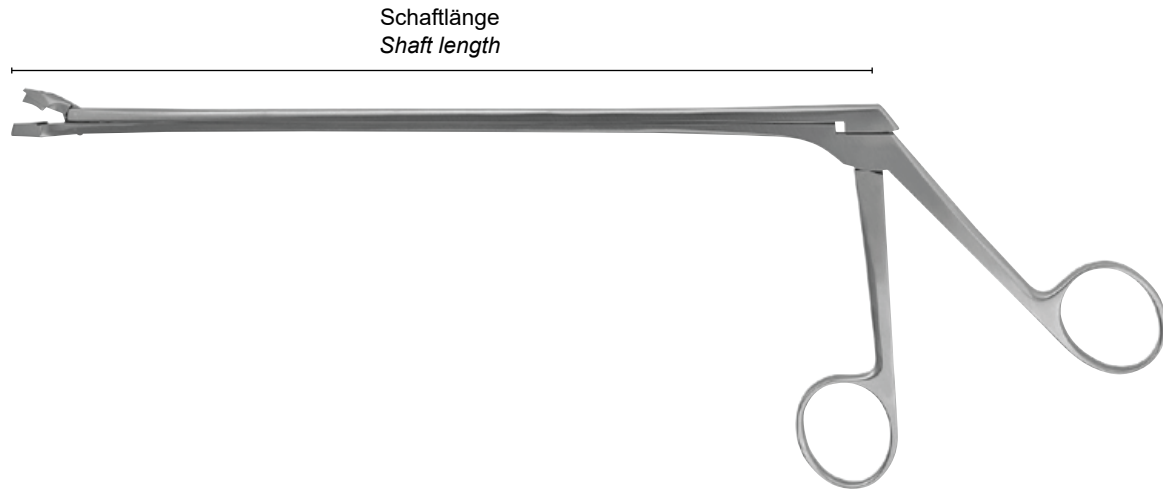

	Bissbreite Bite width	Schaftlänge Shaft length	DOUAY
	4 x 10 mm	20 cm – 8"	ZA 7264-20
		25 cm – 10"	ZA 7264-25
		30 cm – 11¼"	ZA 7264-30



	Bissbreite Bite width	Schaftlänge Shaft length	EPPENDORF
	4 x 8 mm	20 cm – 8"	ZA 7267-00
			ZA 7267-00P
			ZA



	Schaftlänge Shaft length	Bissbreite Bite width	SCHUMACHER
	24 cm – 9½"	4 mm	ZA 7265-00
	24 cm – 9½"	4 mm	ZA 7265-00P
	24 cm – 9½"	6 mm	ZA 7265-06
	24 cm – 9½"	6 mm	ZA 7265-06P



	Bissbreite Bite width	Schaftlänge Shaft length	KEVORKIAN
	3 x 8 mm	24 cm – 9½"	ZA 7266-00
			ZA 7266-00P

ProClean = verbesserte Reinigung dank zerlegbarem Schiebeschaf
Erkennungsmerkmal: zusätzlich endet die Artikelnummer mit dem Buchstaben „P“

ProClean = improved cleaning by dismountable sliding sheath
Identifying feature: additionally the article number ends with the letter "P"

Biopsiezangen Biopsy Forceps

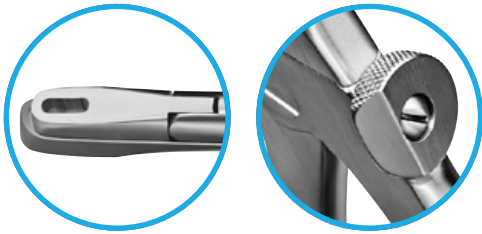

Verriegelung, geschlossen
Lock, locked



Verriegelung, offen
Lock, unlocked

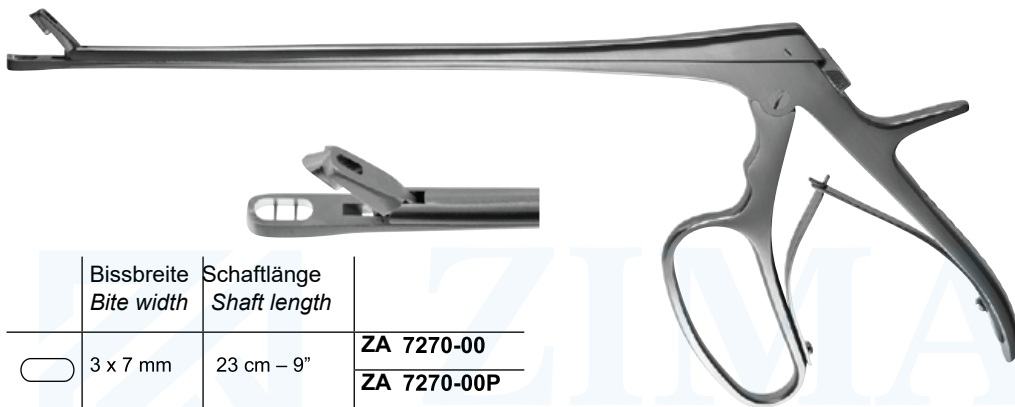

	Bissbreite Bite width	Schaftlänge Shaft length	
	3 x 7 mm	23 cm – 9"	ZA 7270-00
			ZA 7270-00P

TISCHLER-MORGAN

ZIMAIZ
INTERNATIONAL



	Bissbreite Bite width	Schaftlänge Shaft length	
	2,3 x 6,5 mm	21 cm – 8¼"	ZA 7270-50
			ZA 7270-50P

BABY-TISCHLER



Uterus-Biopsiezangen Uterine Biopsy Forceps

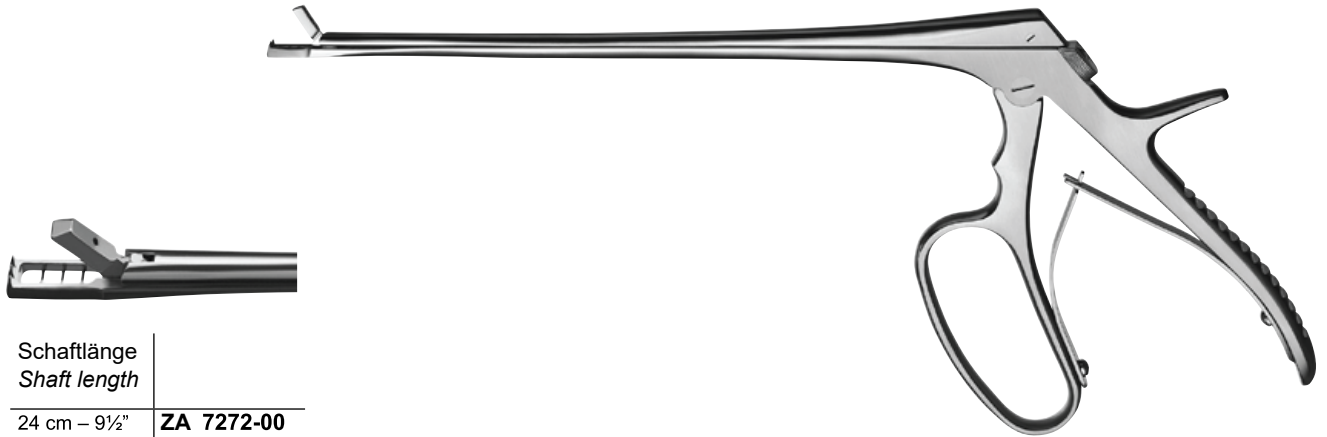

Schaftlänge <i>Shaft length</i>	
24 cm – 9½"	ZA 7272-00

PACIFIC-KEVORKIAN

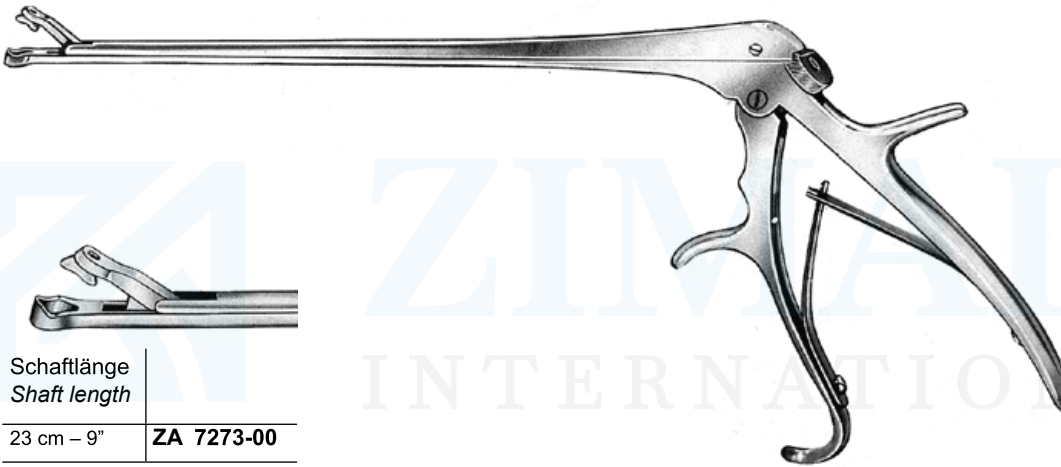

Schaftlänge <i>Shaft length</i>	
23 cm – 9"	ZA 7273-00

BURKE

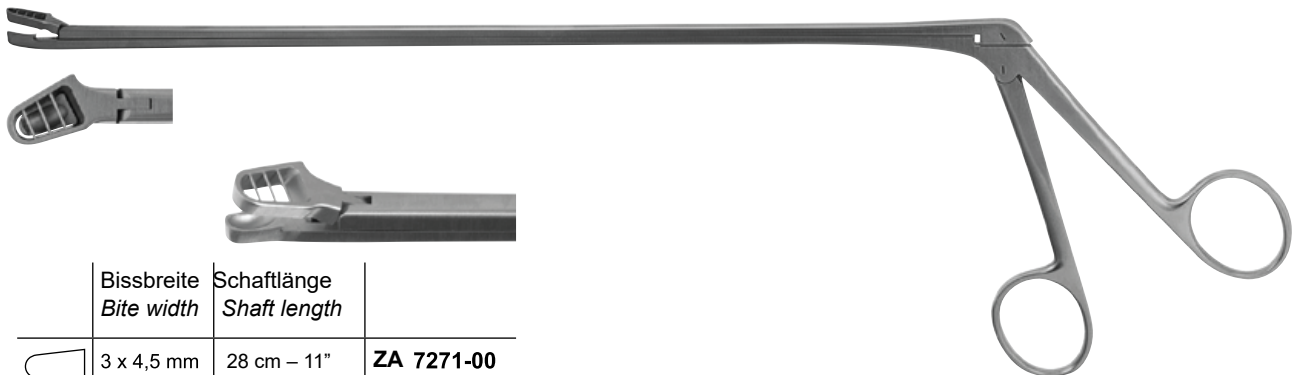

	Bissbreite <i>Bite width</i>	Schaftlänge <i>Shaft length</i>	
	3 x 4,5 mm	28 cm – 11"	ZA 7271-00

ALEXANDER

Uterus-Biopsiezangen Uterine Biopsy Forceps

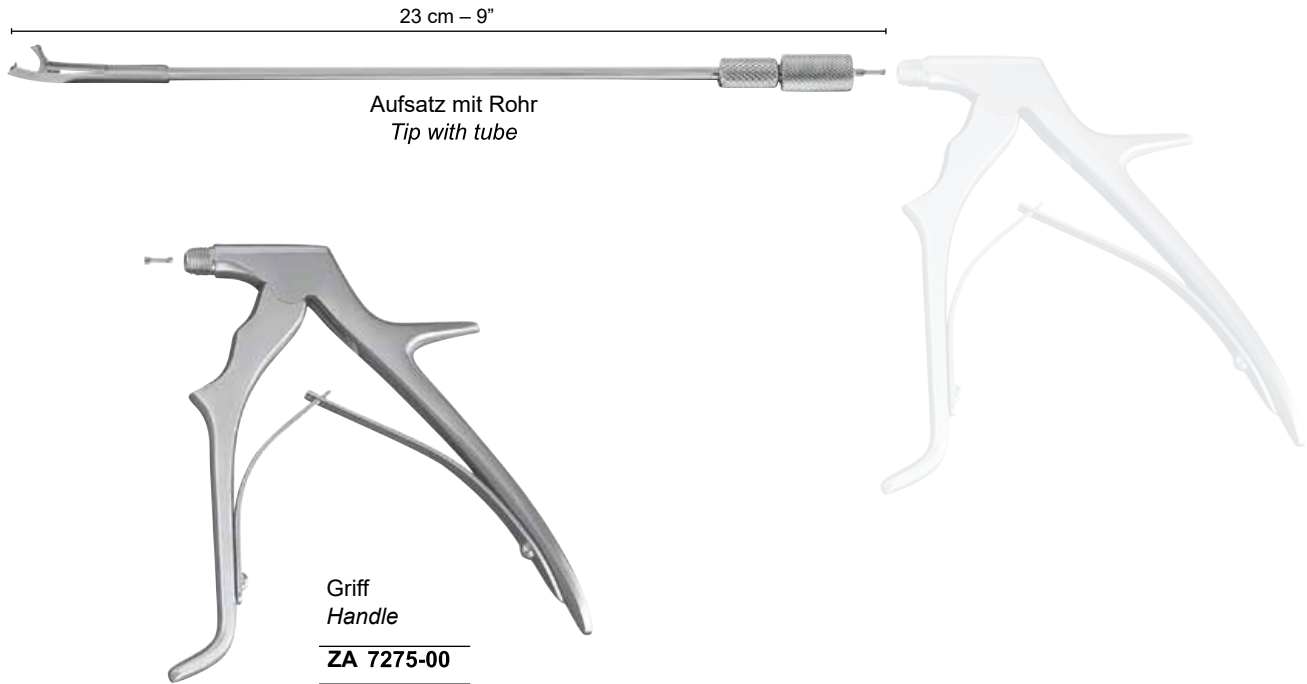

TISCHLER

Längelength	Bissbreite Bite width	Aufsatz, allein, gerade Tip, only, straight
23 cm - 9"	3 x 7 mm	ZA 7275-10

Instrument
komplett
Instrument
complete

ZA 7275-11



MINI-TOWNSEND-UP

Längelength	Bissbreite Bite width	Aufsatz, allein, auf- wärts gebogen, Tip, only, curved up
23 cm - 9"	2,3 x 5 mm	ZA 7275-70

Instrument
komplett
Instrument
complete

ZA 7275-71



MINI-TOWNSEND-DOWN

Längelength	Bissbreite Bite width	Aufsatz, al- lein, abwärts gebogen, Tip, only, curved down
23 cm - 9"	2,3 x 5 mm	ZA 7275-80

Instrument
komplett
Instrument
complete

ZA 7275-81



Uteruslöffel Uterine Scoops



Fig. 1	Fig. 2	Fig. 3	Fig. 4	Fig. 5	Fig. 6
ZA 7280-01	ZA 7280-02	ZA 7280-03	ZA 7280-04	ZA 7280-05	ZA 7280-06

30 cm – 11¾"

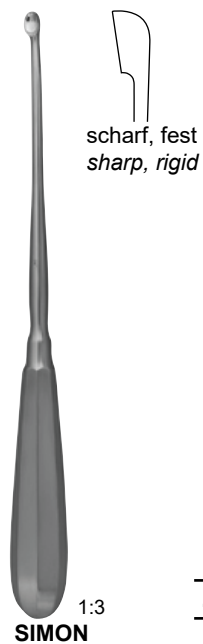
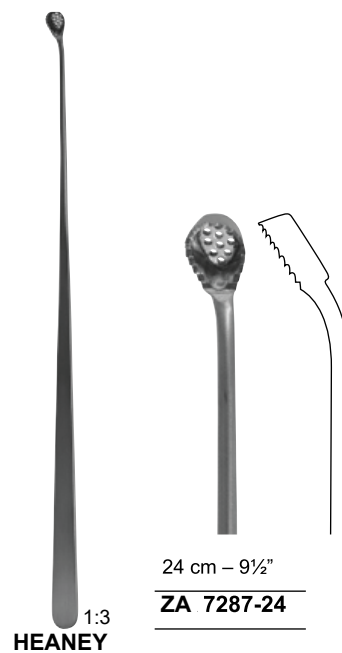
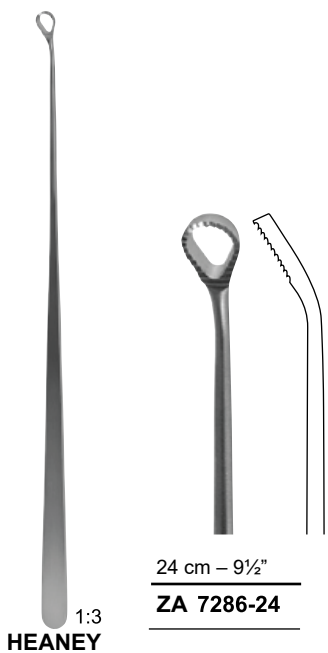
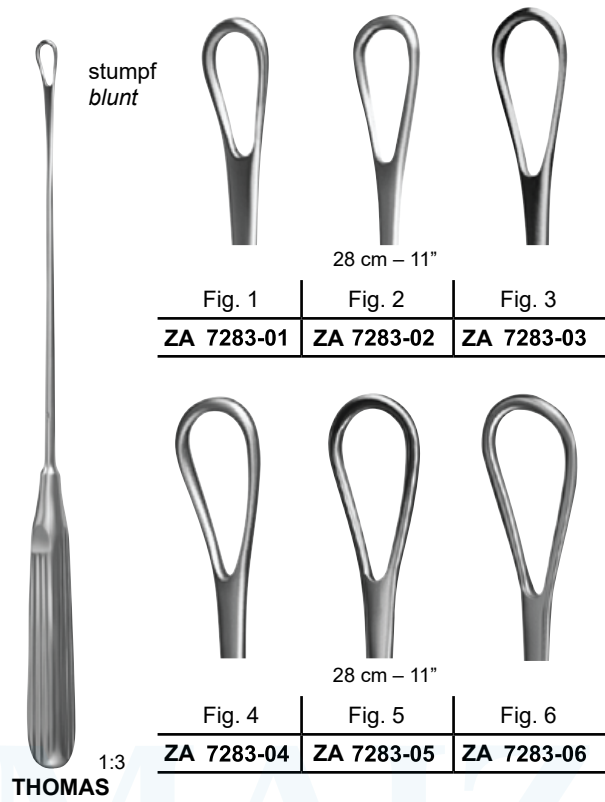
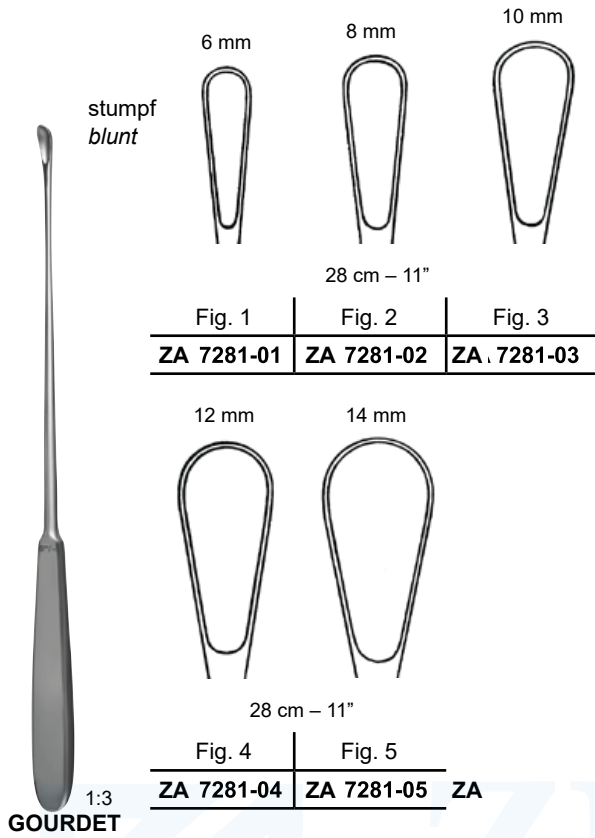

Fig. 1	Fig. 2	Fig. 3	Fig. 4
ZA 7282-01	ZA 7282-02	ZA 7282-03	ZA 7282-04

25 cm – 10"

Uterusküretten Uterine Curettes





Uterusküretten Uterine Curettes

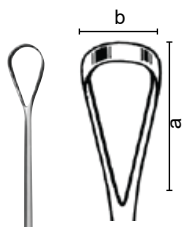

28 cm – 11"



SIMS

	Fig. 1	Fig. 2	Fig. 3	Fig. 4	Fig. 5	Fig. 6
a x b	15 x 7,5 mm	17,5 x 8,5 mm	20 x 10,5 mm	22 x 12 mm	24 x 14 mm	28 x 15 mm
biegsam, scharf <i>malleable, sharp</i>	ZA 7300-01	ZA 7300-02	ZA 7300-03	ZA 7300-04	ZA 7300-05	ZA 7300-06
biegsam, stumpf <i>malleable, blunt</i>	ZA 7302-01	ZA 7302-02	ZA 7302-03	ZA 7302-04	ZA 7302-05	ZA 7302-06
fest, scharfrigid, <i>sharp</i>	ZA 7304-01	ZA 7304-02	ZA 7304-03	ZA 7304-04	ZA 7304-05	ZA 7304-06
fest, stumpfrigid, <i>blunt</i>	ZA 7306-01	ZA 7306-02	ZA 7306-03	ZA 7306-04	ZA 7306-05	ZA 7306-06



ZIMAIZ
INTERNATIONAL

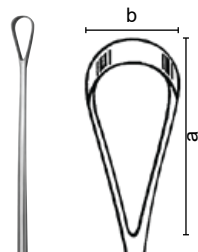

RECAMIER

		26 cm – 10¼"		
		biegsam <i>malleable</i>	festrigid	festrigid
Fig.	a x b mm	scharf <i>sharp</i>	scharf <i>sharp</i>	stumpf <i>blunt</i>
00	9 x 5	ZA 7310-05	ZA 7314-05	ZA 7316-05
0	12 x 6	ZA 7310-06	ZA 7314-06	ZA 7316-06
1	14 x 7	ZA 7310-07	ZA 7314-07	ZA 7316-07
2	16 x 8	ZA 7310-08	ZA 7314-08	ZA 7316-08
3	18 x 9	ZA 7310-09	ZA 7314-09	ZA 7316-09
4	22 x 11	ZA 7310-11	ZA 7314-11	ZA 7316-11
5	24 x 12	ZA 7310-12	ZA 7314-12	ZA 7316-12
6	28 x 14	ZA 7310-14	ZA 7314-14	ZA 7316-14
7	33 x 15	ZA 7310-15	ZA 7314-15	ZA 7316-15
8	35 x 16	ZA 7310-16	ZA 7314-16	ZA 7316-16

Uterusküretten Uterine Curettes

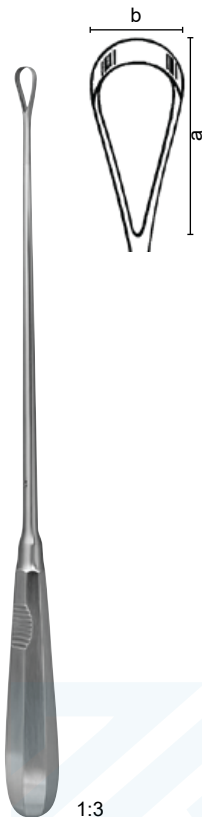

1:3
RECAMIER

Fig.	a x b mm	biegsam	festrigid	festrigid
		malleable	scharfsharp	scharfsharp
31 cm – 12¼"				
00	9 x 5	ZA 7318-05	ZA 7322-05	ZA 7324-05
0	12 x 6	ZA 7318-06	ZA 7322-06	ZA 7324-06
1	14 x 7	ZA 7318-07	ZA 7322-07	ZA 7324-07
2	16 x 8	ZA 7318-08	ZA 7322-08	ZA 7324-08
3	18 x 9	ZA 7318-09	ZA 7322-09	ZA 7324-09
4	22 x 11	ZA 7318-11	ZA 7322-11	ZA 7324-11
5	24 x 12	ZA 7318-12	ZA 7322-12	ZA 7324-12
6	28 x 14	ZA 7318-14	ZA 7322-14	ZA 7324-14
7	33 x 15	ZA 7318-15	ZA 7322-15	ZA 7324-15
8	35 x 16	ZA 7318-16	ZA 7322-16	ZA 7324-16
9	38 x 19	ZA 7318-19	ZA 7322-19	ZA 7324-19
10	40 x 20	ZA 7318-20	ZA 7322-20	ZA 7324-20
11	45 x 21	ZA 7318-21	ZA 7322-21	ZA 7324-21
12	48 x 23	ZA 7318-23	ZA 7322-23	ZA 7324-23
34 cm – 13½"				
13	50 x 25	ZA 7318-25	ZA 7322-25	ZA 7324-25
14	55 x 30	ZA 7318-30	ZA 7322-30	ZA 7324-30
15	60 x 35	ZA 7318-35	ZA 7322-35	ZA 7324-35
16	65 x 40	ZA 7318-40	ZA 7322-40	ZA 7324-40

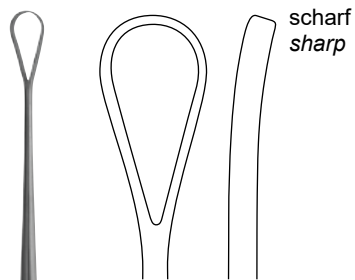

27 cm – 10½"

ZA 7330-27

1:3
BLAKE

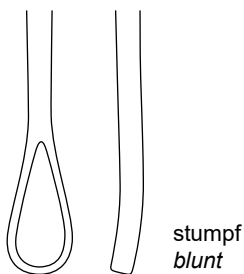



Biopsie- und Absaugküretten Biopsy and Aspirating Curettes



graduiert
graduated

Ø mm	28 cm – 11"
4	ZA 7289-04
6	ZA 7289-06
8	ZA 7289-08
10	ZA 7289-10
12	ZA 7289-12
14	ZA 7289-14

1:3



Schlauch-Verbindungsstück
Tube connecting piece

ZA 7289-50



ZIMAIZ INTERNATIONAL



MILAN

1:3



Ø 5 mm



Ø 7 mm



Ø 9 mm

28,5 cm – 11¼"

biegsam-
malleable

ZA 7290-05

ZA 7290-07

ZA 7290-09



SCHULTZE

Salpingograph zur Hystereo-Salpingographie komplett in Holzetui, bestehend aus: Salpingograph for utero-salpingography <i>complete in wooden case, consisting of:</i>	ZA 7350-00
--	-------------------

- 1 Manometer (ZA 7350-01)
- 1 Manometer (ZA 7350-01)
- 1 Zwischenstück, ohne Manometer (ZA 7350-02)
- 1 Connection, without manometer (ZA 7350-02)
- 1 Tubenkatheter mit Hahn, ohne Kugel (ZA 7350-03)
- 1 Uterine cannula with tap, without cone (ZA 7350-03)
- 1 Kegel, klein (ZA 7350-04)
- 1 Cone, small (ZA 7350-04)
- 1 Kegel, mittel (ZA 7350-05)
- 1 Cone, medium (ZA 7350-05)
- 1 Kegel, groß (ZA 7350-06)
- 1 Cone, large (ZA 7350-06)
- 1 Holzetui (ZA 7350-20)
- 1 Wooden case (ZA 7350-20)

Manometer
Manometer
ZA 7350-01



Zwischenstück
Connection
ZA 7350-02



Tubenkatheter
mit Hahn, ohne Kugel
Uterine cannula
with tap, without cone
ZA 7350-03



ZA 7350-04	ZA 7350-05	ZA 7350-06
-------------------	-------------------	-------------------



Salpingograph Salpingograph



SCHULTZE

Salpingograph zur Hystereo-Salpingographie
komplett in Holzetui, bestehend aus:

ZA 7360-00

Salpingograph for utero-salpingography
complete in wooden case, consisting of:

- 1 Zwischenstück, ohne Manometer (ZA 7350-02)
- 1 Connection, without manometer (ZA 7350-02)
- 1 Tubenkatheter mit Hahn, ohne Kugel (ZA 7350-03)
- 1 Uterine cannula with tap, without cone (ZA 7350-03)
- 1 Kegel, klein (ZA 7350-04)
- 1 Cone, small (ZA 7350-04)
- 1 Kegel, mittel (ZA 7350-05)
- 1 Cone, medium (ZA 7350-05)
- 1 Kegel, groß (ZA 7350-06)
- 1 Cone, large (ZA 7350-06)
- 1 Holzetui (ZA 7350-20)
- 1 Wooden case (ZA 7350-20)

Zwischenstück
Connection

ZA 7350-02



Tubenkatheter
mit Hahn, ohne Kugel
Uterine cannula
with tap, without cone

ZA 7350-03



klein
small

ZA 7350-04



mittel
medium

ZA 7350-05



groß
large

ZA 7350-06



14 cm – 5½"
ZA 3426-14

DE MARTEL (WILLET)



19 cm – 7½"
ZA 7420-19

DE MARTEL (WILLET)



ZIMAIZ
INTERNATIONAL

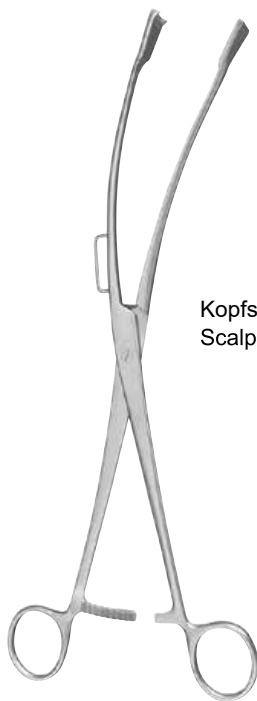

Kopfschwartzange
Scalp flap forceps

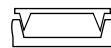

26 cm – 10¼"
ZA 7419-26

GAUSS

1:3



Geburtslöffel *Elevating spoon*

28 cm – 11"
ZA 7425-28

SELLHEIM

1:3



Geburtshilfe
Obstetrics



Perforatorium
Perforator

25 cm – 10"

ZA 7432-25

NÄGELE



Nabelschnurklemme
Umbilical cord clamp

9 cm – 3½"

ZA 7436-29

COLLIN



1:4
SIMPSON-LUIKART

36,5 cm – 14½"
ZA 7447-36



1:3
SIMPSON

23 cm – 9"
ZA 7445-23



ZIMAIZ
INTERNATIONAL



1:4
SIMPSON

30 cm – 11¼"
ZA 7445-30



1:4
WRIGLEY

28 cm – 11"
ZA 7442-28



Geburtszangen Obstetrical Forceps



MC LEAN

1:4

36 cm – 14¼"

ZA 7463-36



SIMPSON-BRAUN

1:4

36 cm – 14¼"

ZA 7446-36



NÄGELE

1:4

36 cm – 14¼"

ZA 7440-36

40 cm – 15¾"

ZA 7440-40



KIELLAND

1:4

41 cm – 16¼"

ZA 7460-41

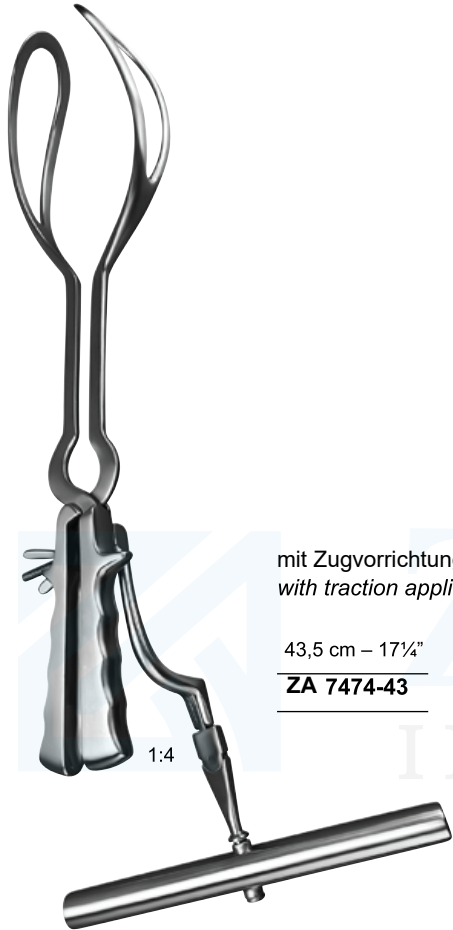

mit Zugvorrichtung
with traction appliance

43,5 cm – 17¼"

ZA 7474-43

1:4

BARNES-NEVILLE



für nachkommenden
Kopf bei Steisslagen
*for delivery of the after
coming head in breech
presentation*

44 cm – 17¼"

ZA 7472-44

1:4

PIPER



Abortuszangen Ovum Forceps



gerade
straight

28 cm – 11"

ZA 7410-01	ZA 7410-02	ZA 7410-03
-------------------	-------------------	-------------------



ZIMAIZ
INTERNATIONAL



gebogen
curved

28 cm – 11"

ZA 7411-01	ZA 7411-02	ZA 7411-03
-------------------	-------------------	-------------------

Abortus- und Plazentanzangen Ovum and Placenta Forceps

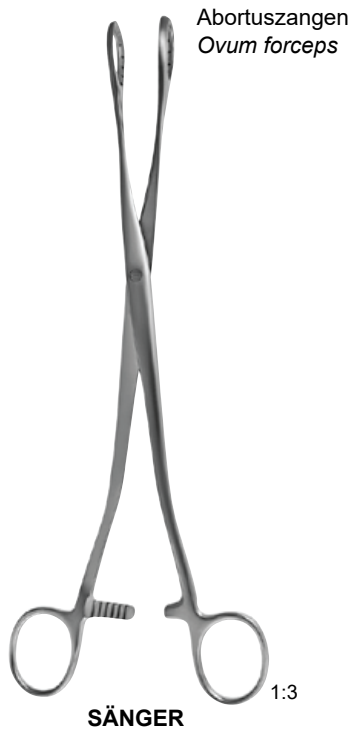

gerade
straight



gebogen
curved

27 cm – 10½"

ZA 7414-27

ZA 7415-27



ZIMAIZ
INTERNATIONAL

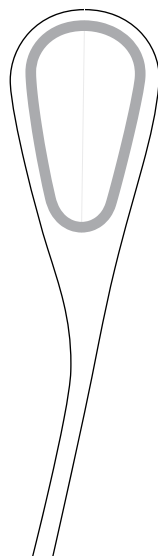

leicht gebogen
slightly curved

25,5 cm – 10"

ZA 7413-25



Uterusklemmzangen
Uterine Forceps

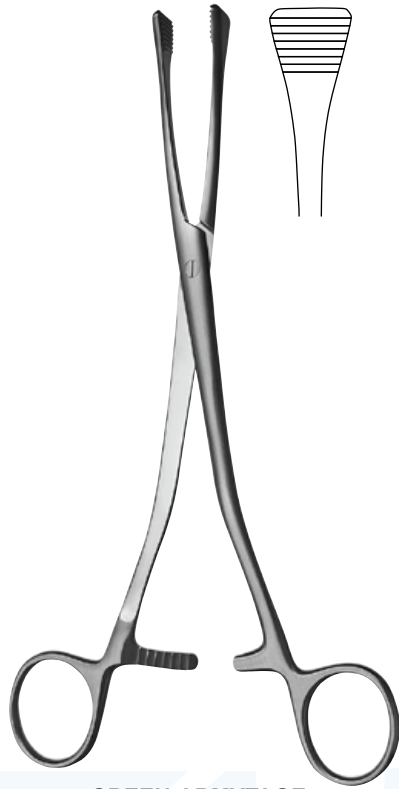

21 cm – 8¼"
ZA 7418-21



ZIMAIZ
INTERNATIONAL